



28466

# 4040XP/4041DA



Drop Plate

Installation Instructions

## 4040XP & 4041DA PUSH SIDE (TOP JAMB) DROP PLATE PERMITS 120° MAXIMUM OPENING

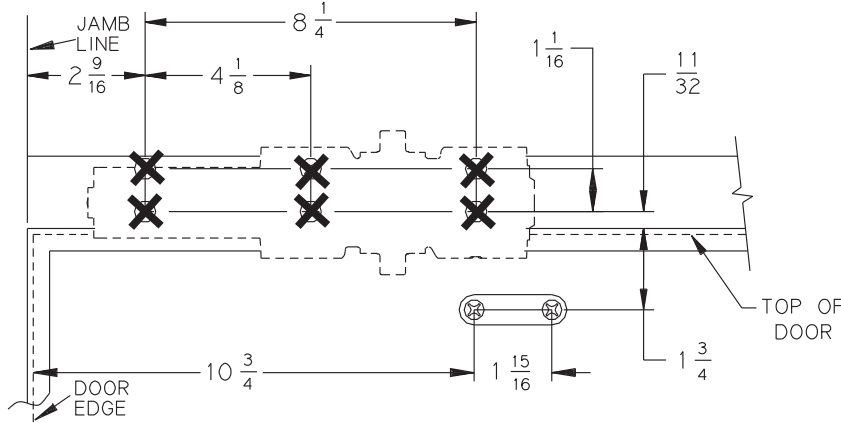

LEFT HAND DOOR SHOWN, RIGHT HAND OPPOSITE.

MAXIMUM REVEAL OF 2 9/16.  
FOR REVEALS 2 5/8 - 4 13/16  
SPECIFY LONG ROD.  
FOR REVEALS 8"  
SPECIFY EXTRA LONG ROD.

Locate drop plate & shoe from centerline of pivot or swing clear hinge pin when used.

## PUSH SIDE MOUNT ON: 4040-18TJ DROP PLATE

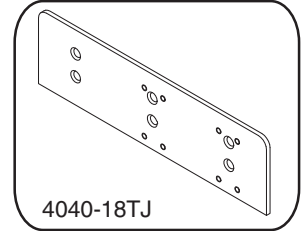

4040-18TJ

## 4040XP & 4041DA PUSH SIDE (TOP JAMB) DROP PLATE PERMITS 120° MAXIMUM OPENING

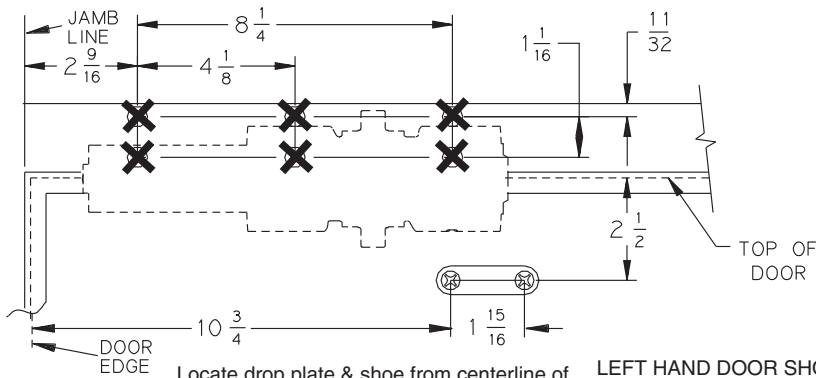

Locate drop plate & shoe from centerline of pivot or swing clear hinge pin when used.

LEFT HAND DOOR SHOWN, RIGHT HAND OPPOSITE.

## PUSH SIDE MOUNT ON: 4040-18G DROP PLATE

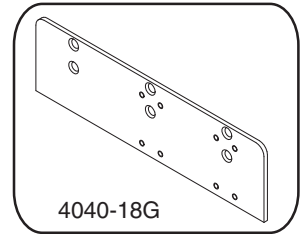

4040-18G

MAXIMUM REVEAL OF 2 9/16.  
FOR REVEALS 2 5/8 - 4 13/16  
SPECIFY LONG ROD.  
FOR REVEALS 8"  
SPECIFY EXTRA LONG ROD.

## 4040XP & 4041DA PULL SIDE (DOOR JAMB) DROP PLATE PERMITS 120° MAXIMUM OPENING

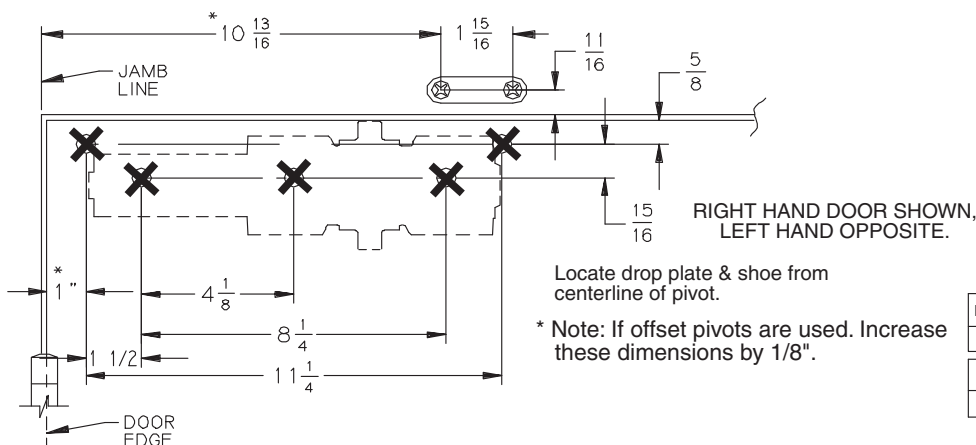

Locate drop plate & shoe from centerline of pivot.

\* Note: If offset pivots are used. Increase these dimensions by 1/8".

## PULL SIDE MOUNT ON: 4040-18 DROP PLATE

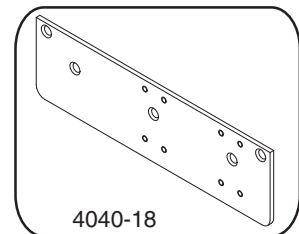

4040-18

INCH	11/32	5/8	11/16	15/16	1	1 1/16	1 1/2	1 3/4
M.M.	9	16	17	24	25	27	38	44
INCH	1 15/16	2 1/2	2 9/16	4 1/8	8 1/4	10 3/4	10 13/16	11 1/4
M.M.	49	64	65	105	210	273	275	286

**4040XP PA PUSH SIDE (DOOR MOUNT) DROP PLATE PERMITS 180° MAX. OPENING, BUTT SIZE 5x5 MAX.**

**PUSH SIDE MOUNT ON:  
4040-18PA DROP PLATE**

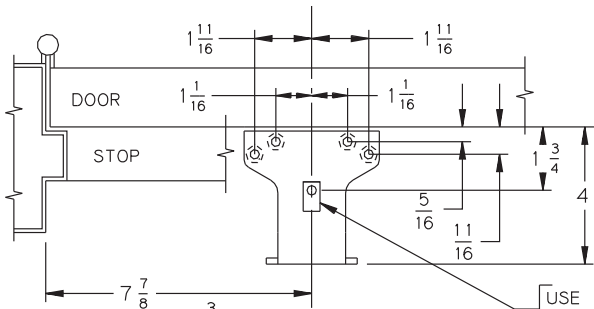

**IMPORTANT**  
Before installing closer, turn backcheck selector valve (found on opposite side of closer from regulating screw side) all the way in (clockwise).

**IMPORTANT**

USE SPACER BLOCK PROVIDED FOR FIFTH SCREW. 1/2 OR 5/8

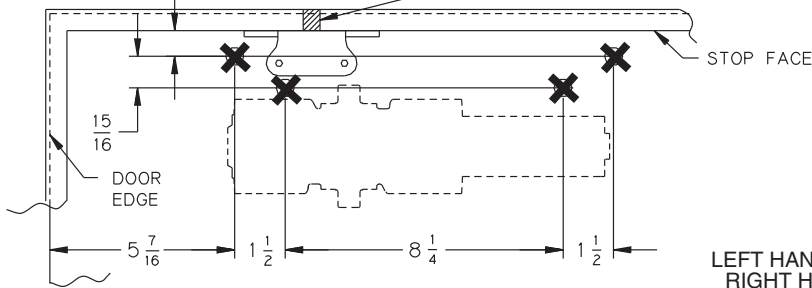

Locate drop plate & shoe from centerline of pivot or swing clear hinge pin when used.

LEFT HAND DOOR SHOWN,  
RIGHT HAND OPPOSITE.

**4041PA DELAY PUSH SIDE (DOOR MOUNT) DROP PLATE**

**PUSH SIDE MOUNT ON:  
4040-18PA DROP PLATE**

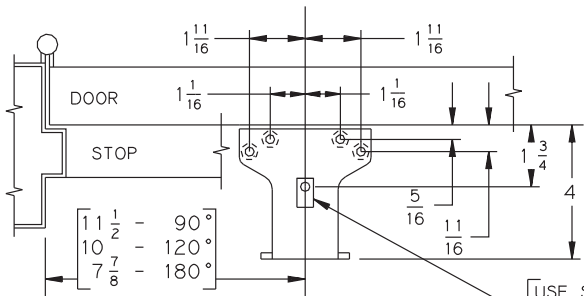

**IMPORTANT**  
Before installing closer, turn backcheck selector valve (found on opposite side of closer from regulating screw side) all the way in (clockwise).

**IMPORTANT**

USE SPACER BLOCK PROVIDED FOR FIFTH SCREW. 1/2 OR 5/8

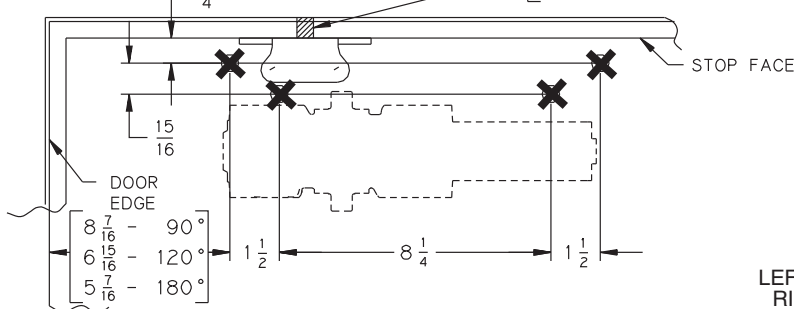

Locate drop plate & shoe from centerline of pivot or swing clear hinge pin when used.

LEFT HAND DOOR SHOWN,  
RIGHT HAND OPPOSITE.

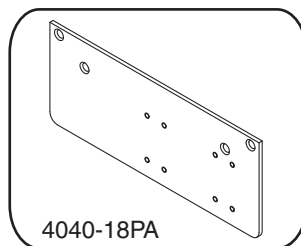

INCH	5/16	11/16	3/4	15/16	1 1/16	1 1/2	1 11/16	1 3/4
M.M.	8	17	19	24	27	38	43	44
INCH	4	5 7/16	6 15/16	7 7/8	8 1/4	8 7/16	10	11 1/2
M.M.	102	138	176	200	210	214	254	292

**4040XP CUSH PUSH SIDE (DOOR MOUNT) DROP PLATE PERMITS 110° MAX. OPENING, MIN. TOP RAIL 2 1/2".**

**PUSH SIDE MOUNT ON: 4040-18PA DROP PLATE**

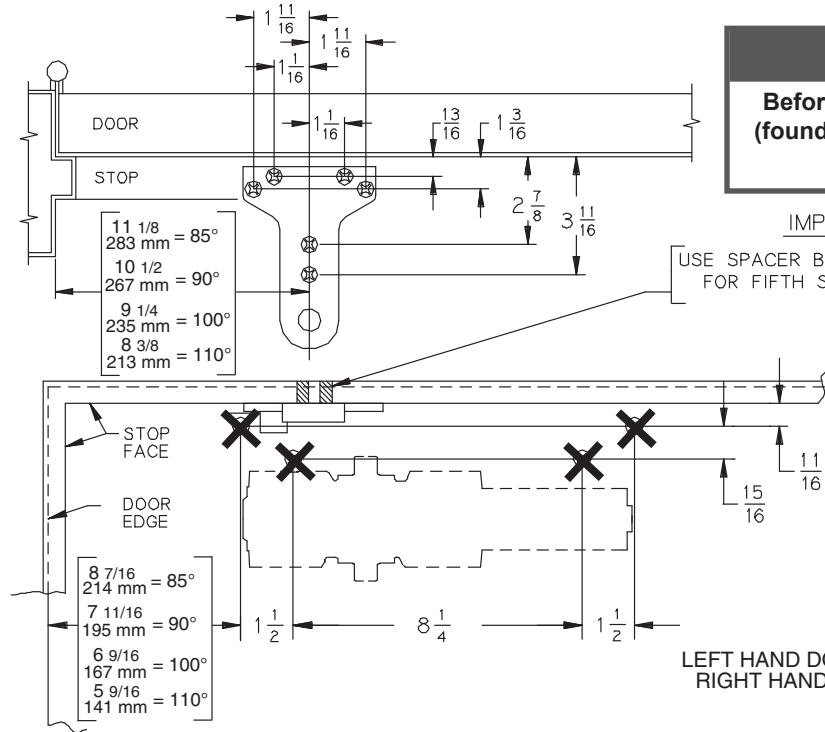

**IMPORTANT**  
Before installing closer, turn backcheck selector valve (found on opposite side of closer from regulating screw side) all the way in (clockwise).

**IMPORTANT**  
USE SPACER BLOCK PROVIDED FOR FIFTH SCREW. 1/2 OR 5/8

Locate drop plate & shoe from centerline of pivot or swing clear hinge pin when used.

LEFT HAND DOOR SHOWN, RIGHT HAND OPPOSITE.

**4040XP EDA PUSH SIDE (DOOR MOUNT) DROP PLATE PERMITS 180° MAX. OPENING, MIN. TOP RAIL 2 1/2".**

**PUSH SIDE MOUNT ON: 4040-18PA DROP PLATE**

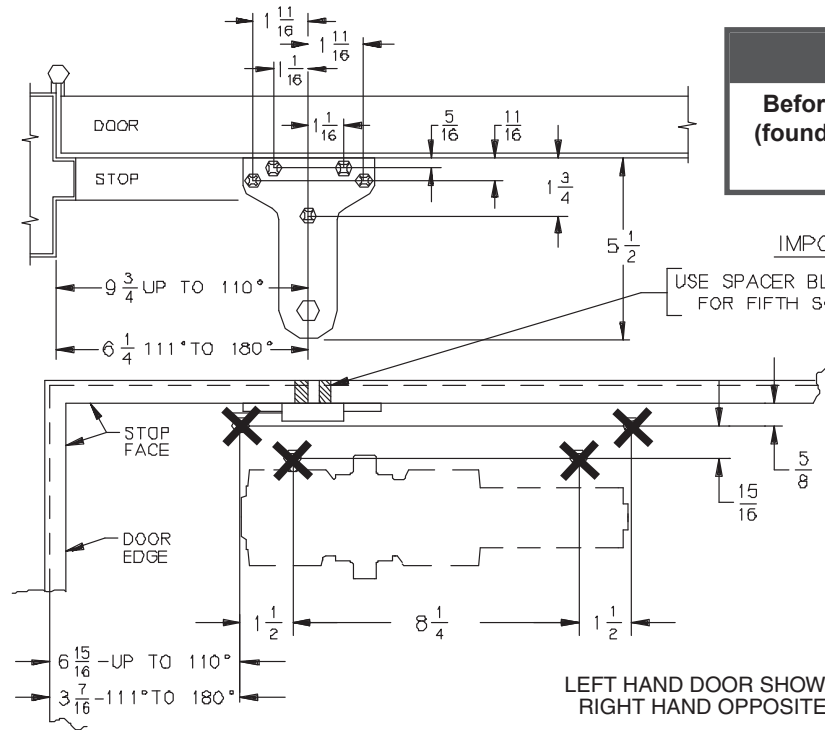

**IMPORTANT**  
Before installing closer, turn backcheck selector valve (found on opposite side of closer from regulating screw side) all the way in (clockwise).

**IMPORTANT**  
USE SPACER BLOCK PROVIDED FOR FIFTH SCREW. 1/2 OR 5/8

Locate drop plate & shoe from centerline of pivot or swing clear hinge pin when used.

LEFT HAND DOOR SHOWN, RIGHT HAND OPPOSITE.

INCH	5/16	1/2	5/8	11/16	13/16	15/16	1 1/16	1 3/16	1 1/2
M.M.	8	13	16	17	21	24	27	30	38
INCH	1 11/16	1 3/4	2 7/8	3 7/16	3 11/16	5 1/2	5 7/8	6 1/4	6 11/16
M.M.	43	44	73	87	94	140	149	159	170
INCH	6 15/16	8 1/16	8 1/4	8 9/16	8 5/8	9 1/2	9 3/4	10 13/16	11 1/4
M.M.	176	205	210	217	219	241	248	275	286

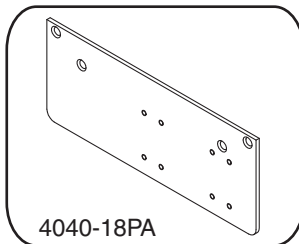

4040-18PA

**4040XPT PULL SIDE (DOOR MOUNT) DROP PLATE**  
**PERMITS 120° MAXIMUM OPENING, MIN. TOP RAIL 1 13/16"**

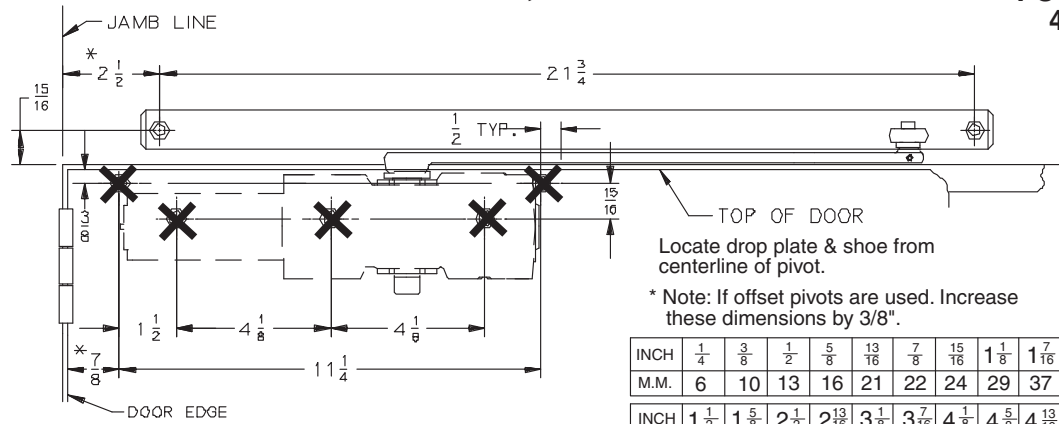

\* Note: If offset pivots are used. Increase these dimensions by 3/8".

INCH	1/4	3/8	1/2	5/8	13/16	7/8	15/16	1 1/8	1 7/16
M.M.	6	10	13	16	21	22	24	29	37
INCH	1 1/2	1 5/8	2 1/2	2 13/16	3 1/8	3 7/16	4 1/8	4 5/8	4 13/16
M.M.	38	41	64	71	79	87	105	117	122
INCH	5 3/8	5 5/8	9 3/4	11 1/4	21 3/4				
M.M.	137	143	248	286	553				

RIGHT HAND DOOR SHOWN, LEFT HAND OPPOSITE.

**PUSH SIDE MOUNT ON:**  
**4040-18 DROP PLATE**

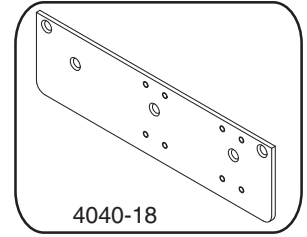

**4040XPT PULL SIDE (TOP JAMB) DROP PLATE**  
**PERMITS 180° MAXIMUM OPENING, MIN. FACE OF FRAME 1 3/4"**

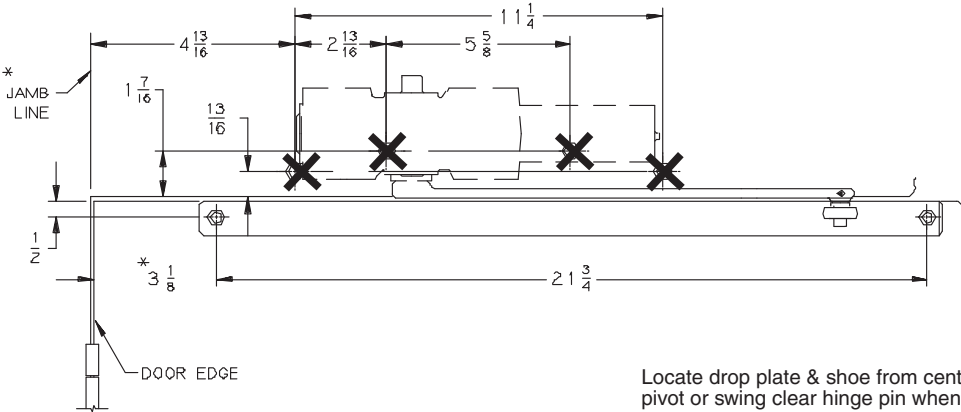

Locate drop plate & shoe from centerline of pivot or swing clear hinge pin when used.

RIGHT HAND DOOR SHOWN, LEFT HAND OPPOSITE.

**PUSH SIDE MOUNT ON:**  
**4040T-18 DROP PLATE**

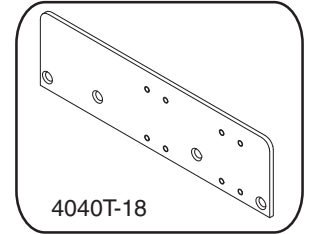

**4040XPT PUSH SIDE (DOOR MOUNT) DROP PLATE**  
**PERMITS 120° MAXIMUM OPENING, MIN. TOP RAIL 2 1/4"**

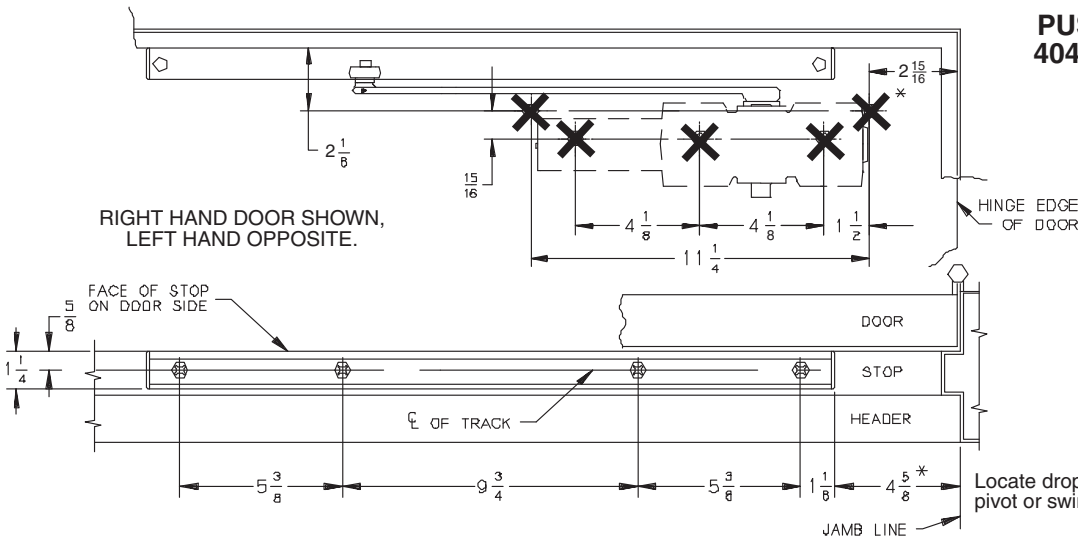

Locate drop plate & shoe from centerline of pivot or swing clear hinge pin when used.

**PUSH SIDE MOUNT ON:**  
**4040-18PA DROP PLATE**

