

INCHES
MILLIMETERS
Nominal, subject to tolerance extremes.

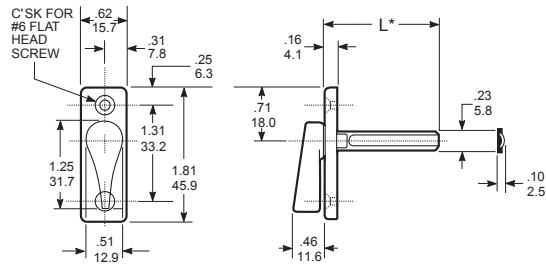

Turn with Escutcheon
Furnished Assembled

1000-21
PERPENDICULAR DRIVE

1000-11
PARALLEL DRIVE

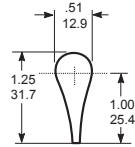

Turn without Escutcheon
Furnished Unassembled

1000-02
PERPENDICULAR DRIVE

1000-01
PARALLEL DRIVE

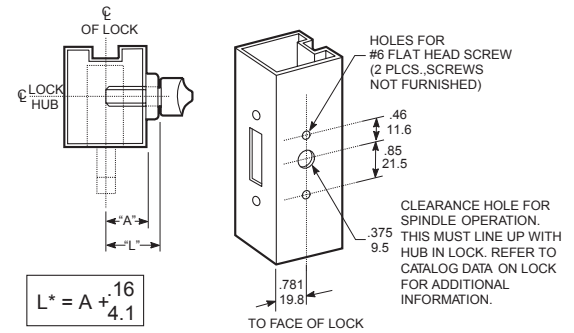
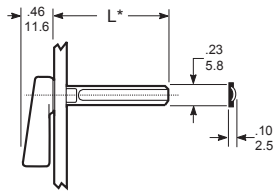

Stile Preparation
Dash -11 or -21

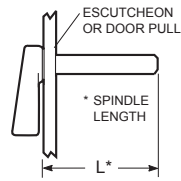

Second Dash Number			
No.	"L"	No.	"L"
-11	.54 (13)	-22	1.23 (31)
-12	.61 (15)	-23	1.29 (33)
-13	.67 (16)	-24	1.36 (34)
-14	.73 (18)	-25	1.42 (36)
-15	.79 (20)	-26	1.48 (37)
-16	.86 (22)	-27	1.52 (38)
-17	.92 (23)	-28	1.61 (41)
-18	.98 (24)	-29	1.67 (42)
-19	1.04 (26)	-30	1.73 (43)
-20	1.11 (26)	-31	1.79 (45)
-21	1.17 (30)	-32	1.86 (47)

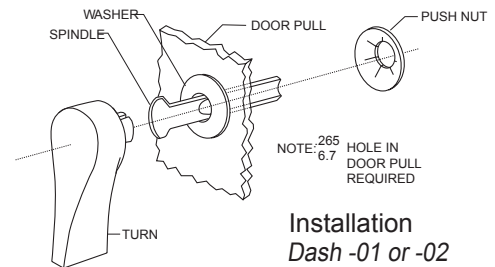
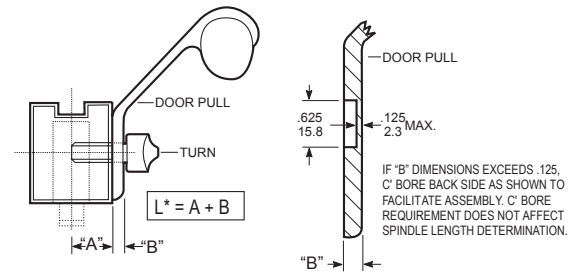

Installation
Dash -01 or -02



ADAMS RITE MANUFACTURING CO.

260 Santa Fe Street, Pomona, CA 91767
Phone: (909) 632-2300 Fax: (909) 632-2369

1000 Series Turns