



18755

2010 Series

LCN®

Installation Instructions

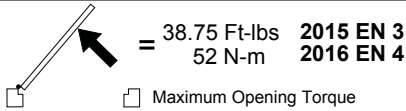

Instructions

1. Make sure hand of closer and door correspond. Hand of closer is stamped on finish plate. Hand of closer can not be reversed.
2. If door and frame are not prepared for closer and track, prepare to dimensions shown on other side.
3. Install closer in prepared frame with proper screws. Replace finish plate (or frame plate provided by frame manufacturer) and be sure plate is flush with soffit. Place arm on closer shaft and secure with shaft screw. Insert track roller in track. Install track level in door.
4. Hang door on butts. Be sure there is no bind or friction. Open door 45° and pull arm away from stop. Using allen wrench furnished, back out arm set screw to clear arm roller stud. **DO NOT DRIVE ARM DOWN OVER ROLLER STUD.** Lift end of arm up and over roller and gently fit roller stud into arm. Tighten self locking set screw.

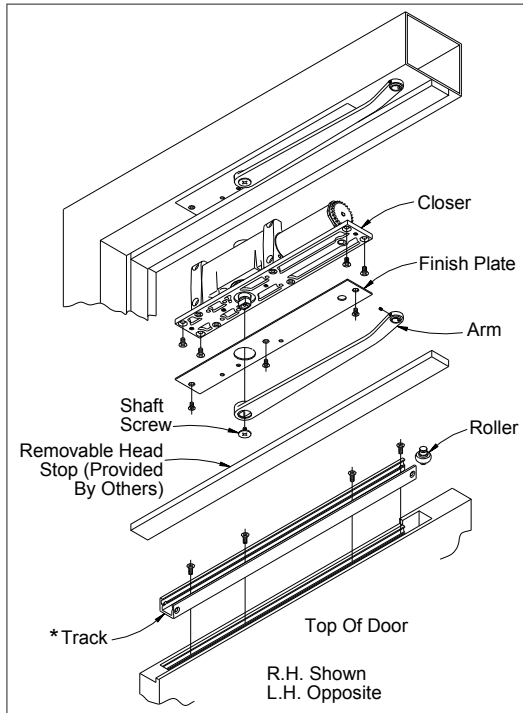

CAUTION

Improper installation or regulation may result in personal injury or property damage. Follow all instructions carefully. For questions, call LCN at 877-671-7011

5. **IMPORTANT:** Closer has been regulated prior to shipment. Adjust regulation only if necessary. Use a 3/32" hex wrench and to adjust speed (see illustration). To slow main speed of door, turn regulating screw nearest shaft clockwise. To slow latch speed of door, turn regulating screw nearest hinge clockwise. **BACKCHECK** To increase backcheck intensity, turn regulating screw nearest latch clockwise.

① **Do not use abrupt backcheck- nor expect door closer to act as a door stop.**

Customer Service
 1-877-671-7011 www.allegion.com/us

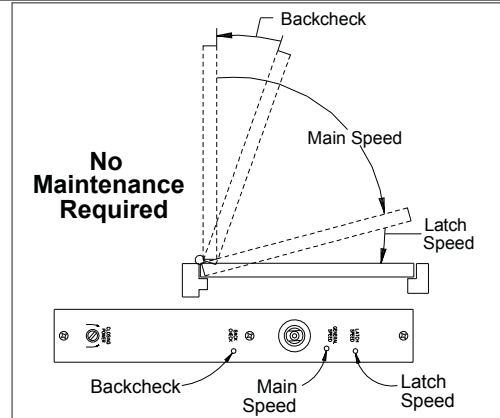

6. Adjust **CLOSING POWER** only if more power is needed. Closer is shipped with minimum closing power preset. To increase **CLOSING POWER** turn spring adjusting screw clockwise. Maximum adjustment is 18 turns.

Table of Sizes		
Maximum Door Width		
Exterior Doors	Interior Doors	Catalog No. of Closers
----		2011
30 (765 mm)	38 (965 mm)	2013
36 (915 mm)	48 (1220 mm)	2014
42 (1065 mm)	54 (1370 mm)	2015
48 (1220 mm)	60 (1525 mm)	2016

7. **HOLD OPEN ADJUSTMENT:** Change the hold open position by removing screws (1) and then (3). Locate to required position as shown. (See illustration for hold-open spring clip position.) Install screw (3) securely. Tip cam (2) into track and locate as shown. Install long green screw (1) securely. Push door into hold open position. For **INCREASED HOLDING POWER**, loosen long green screw (1), slide cam (2) **TOWARD LATCH**, retighten long green screw (1) securely. For **DECREASED HOLDING POWER**, loosen long green screw (1), slide cam (2) **TOWARD HINGE** edge of door, retighten long green screw (1) securely.

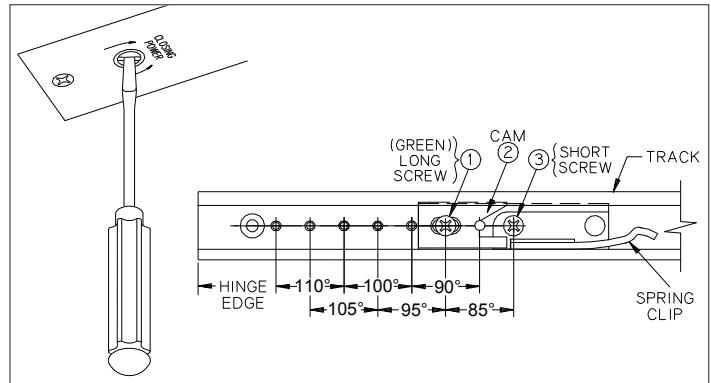

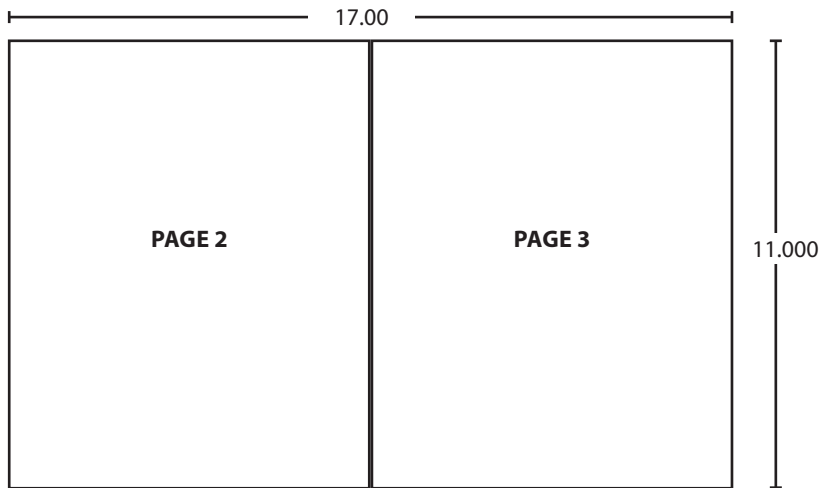

BEGINNING SHEET

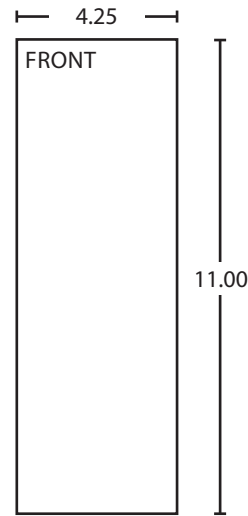
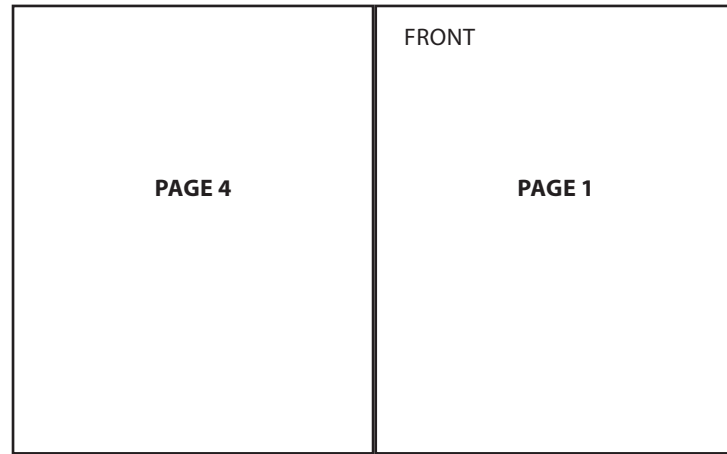

FOLDED SHEET

Additional Notes:
1. None

Revision History						Revision Description:					
J	K	L	M	N	P	J > Revised artwork					
043228											
Material						Edited By		Approved By		EC Number	Release Date
White Paper						D. Myers		M. Sasso		043228	01-01-14
Notes						Title					
1. printed two sides						2010 Series Instruction Sheet					
2. printed black						Creation Date		Number		Revision	
3. tolerance ± .13						05-10-10		18755		J	
4. printed in country may vary						Created By		Activity		© Allegion 2014	
5. drawings not to scale						N/A		3899 Hancock Expwy Security, CO 80911			
						Software: InDesign CS6					