



The 9540 SENIOR SWING by LCN is an ADA door operator that is a two-in-one swing door operator. SENIOR SWING operators when activated, opens doors automatically for wheelchair access, yet allows for manual operation for regular pedestrian traffic.

| | | | |
|-----------------------|---|---|---|
| Certifications | Grade 1 - ANSI A156.19, UL325/228, UL1998, ADA, 100 Hour Salt Spray, Meets BAA - Buy American Act | Fasteners | Machine screw pack |
| Fluid | All Weather Fluid | Mounting | Single door, surface mount, offset pivot, butt hinge (Pull Side) |
| Handing | Handed | Arms | Regular Arm (3077) |
| Door Width | <ul style="list-style-type: none"> ■ Minimum door width 33" - 48" ■ Single door - width per leaf 33" minimum, 48" maximum | Finishes/Colors/ Powder Coat | <ul style="list-style-type: none"> ■ Anodized Aluminum ■ Anodized Dark Bronze |
| Warranty | 2 years | | |

**Special
Templates**

Customized installation templates or products may be available to solve unusual applications. Contact LCN Product Support for assistance.

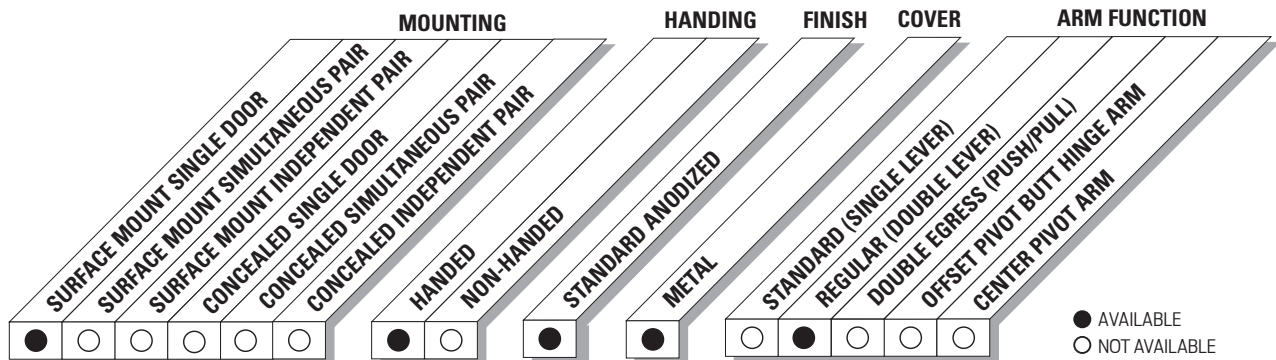

9540 Series Senior Swing

Mounting details

Top Jamb Single Door Mounting

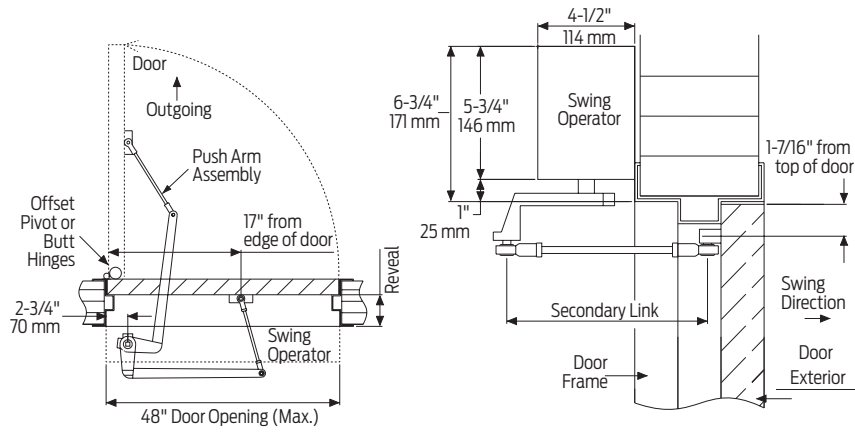

Offset pivot/butt hinge, center pivot, push
Consult factory for all balance door installations.

The 18 plate is 6-3/4" thick and will need to be ordered 3-1/2" longer than the header to allow for mounting the angle brackets to the vertical side jambs. See illustration below.

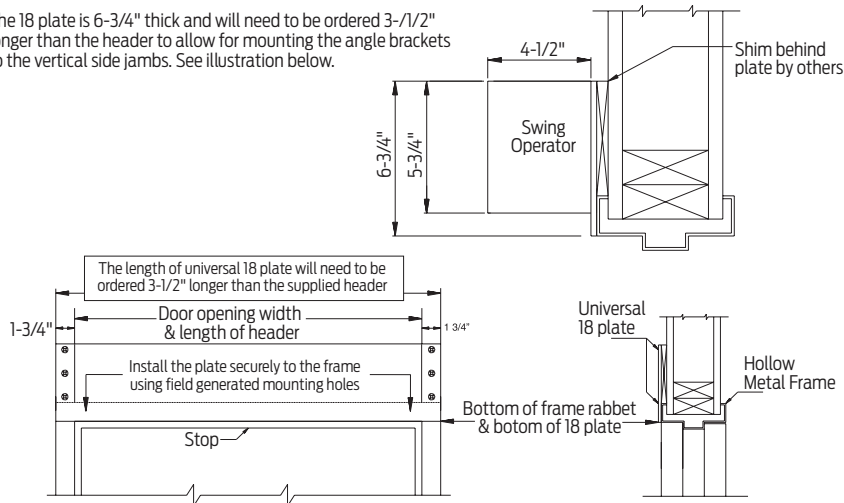

Hollow metal frame
Suggested Installation.

| | |
|---------------------------------|---|
| Butt Hinges | Should not exceed 5" (127 mm) in width |
| Reveal | push installations should not exceed 10" (254 mm) for REGULAR ARM and 20" (508 mm) for LONG ARM |
| Head Frame | Minimum 1-3/4" (44 mm). Face frame 6-3/4" (171 mm) total operator clearance |
| Top Rail | Minimum 2-3/4" (70 mm) |
| Opening and Closing Time | <ul style="list-style-type: none"> ■ Variable by adjustments to the electronic control box ■ Maximum hold open time adjustable up to approximately 32 seconds |
| System Diagram | See "AUTOMATIC OPERATORS" section page 51 for typical system wiring and page 53 for electrical data |
| Maximum Opening | Template allows 90 degree power opening and 90 degree manual opening |

Notes:

- Push N' Go permits non-switch activation with a power boost providing additional latching force
- Electromechanical unit with microprocessor control
- Digital keypad for easy setup
- 36" header length is standard. Specify 33" - 48" max
- Double door header available up to 98", specify other length 49" - 98" max
- Adjustable hold open period of 2 - 32 seconds in automatic or manual mode
- Actuators available separately, see pages 115-131

Motor Gearbox



**9540-3454
Motor Gearbox**

- Senior swing
- Handed
- Driving mechanism for operator
- Provides maximum 15 lbs opening force

Mount Brackets



**9540-275
Mounting Bracket**

- Motor gearbox mounting bracket for 2-3/4" offset pivot or butt hinge installations
- Front bracket



**9540-3018
Rear Mounting Bracket**

- Motor gearbox mounting bracket
- Rear bracket



**9540-334-1
Angled Bracket**

- Mounting bracket for surface applications (includes 2 mounting brackets)

Control Box

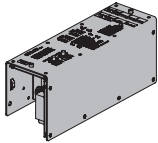

**9540-3462
Control Box**

- Electronic controlling device for Senior Swing

Headers



**9540-3572HL
Header**

- Single door, single operator
- Specify length 33" to 48" maximum
- Standard



**9540-3572DD
Header**

- Double door, single operator
- Specify length 49" to 98" maximum
- Standard

End Caps



**9540-334
Header End Caps**

- With openings for wiring

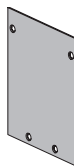

**9540-334-2
End Dress Plate**

- Metal finish end cap

9540 Series Senior Swing

Accessories

Arms

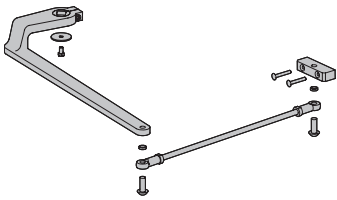

9540-3077 Regular Arm Assembly

- Handed
- Includes 77 main arm assembly and 79 linkage assembly

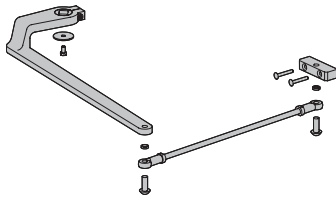

9540-3077L Regular Long Arm Assembly

- Handed
- Includes 77 main arm assembly and 79LR linkage assembly

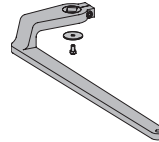

9540-77 Main Arm

- Handed
- Attaches to motor gearbox

Tracks

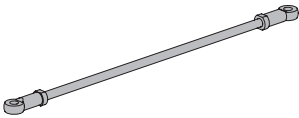

9540-79 Linkage Assembly - 15"

- Threaded rod attaches to door
- Extends from main arm

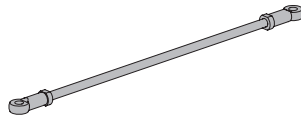

9540-79LR Linkage Assembly - 32"

- Threaded long rod attaches to door
- Extends from main arm.
- Used for reveal 10" to 20"

Installation Accessories



9540-11A Spindle Plate

- Hides bottom of motor gearbox
- Completes header box
- Cutout allows for motor gearbox shaft
- For 2-3/4" offset pivot or butt hinge installations



9540-12 Filler Plate Blank

- Completes length of header box (specify length)



9540-18 Mounting Plate

- For standard hollow metal door frames
- Specify length 55-1/2" to 101-1/2" maximum when using angle brackets
- Specify length 52" to 98" maximum when using dress plates
- Optional

NOTE: The length of a universal 18 plate will need to be ordered 3-1/2" longer than the supplied header when using angle brackets.

How-to-order 9540 Series closers

Specify hand

- RH
- LH

Specify header/length

- HL__ (Specify length 33" to 48")
- DD__ (Specify length 49" to 98")

Specify finish

- Standard Anodized Finish _____
Aluminum or Dark Bronze

Operator will be shipped with:

- Standard motor gearbox
- Standard control box
- Header (at specified length, 36" standard)
- Regular arm (3077)
- 2-3/4" pivot point
- Machine screw pack
unless options listed below are selected.

Operator options

Mounting plate

- Plate, __ (Specify Length 33" to 101-1/2")

Arm

- Long Arm (3077L)

Table of sizes



Indicates recommended range of door width for operator.

*NOTE: For all Senior Swing Series.
Single Door - Width per leaf 33" minimum, 48" maximum.*