



931239-00

6121/6121DS

VON DUPRIN

Electric Strike, Double Door Closed Back Rim Application

Installation Instructions

Note: Check with factory for retrofit applications.

1. For lock or device preparation, see their directions. Also see application schedule below.
2. Prepare door for strike (see other side).
3. Wire strike (Figure 1). (Switches on 6121DS only.)

4. Test strike: Apply solenoid power. Fail secure (FSE) lip unlocks. Fail safe (FS) lip locks. Figure 1 shows status of switches.
5. Install strike with two #12-24 screws. Make sure clearance between latch bolt and strike lip is 1/32" (Figure 2). If not, uninstall strike, adjust (Figure 3), and reinstall.
6. If latch bolt does not extend far enough to actuate tripper, install extension (Figure 4). (Tripper on 6121DS only.)

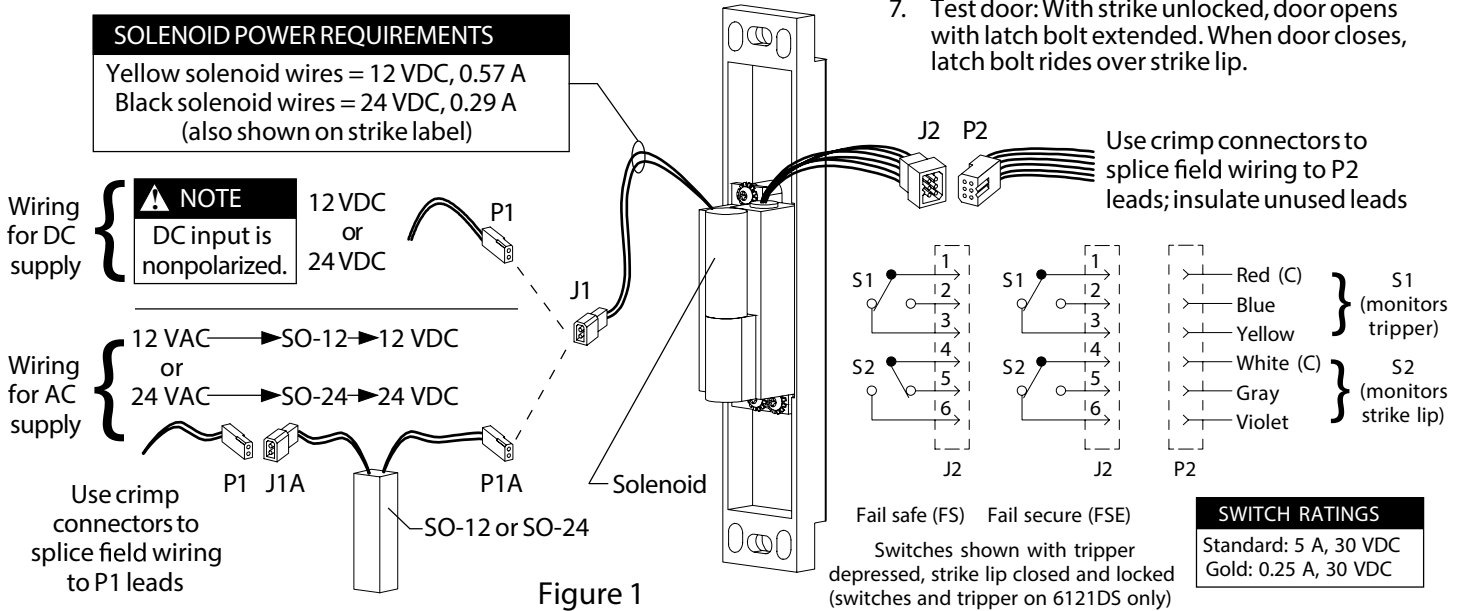
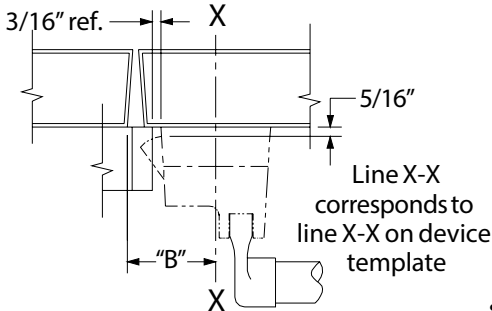

Figure 1

Von Duprin Device	"B"
22 Rim and 98/99 Rim	2-7/16"
33/35 Rim EO/DT/NL/TP	1-13/16"
33A/35A Series Rim	1-15/32"
88 Rim EO/DT/NL/TP	2-1/2"
88 Rim K	2-3/8"
For other devices, consult factory.	



Application Schedule

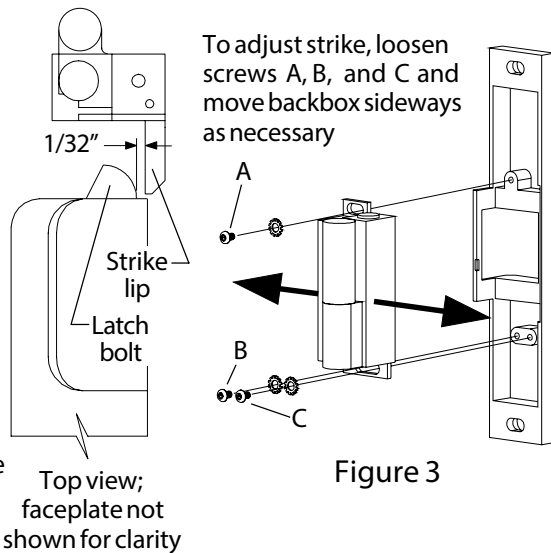

Figure 2

To adjust strike, loosen screws A, B, and C and move backbox sideways as necessary

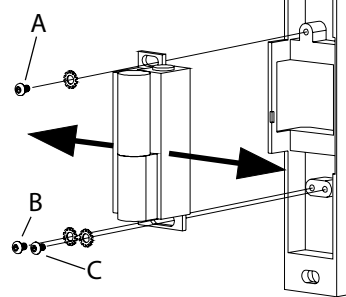

Figure 3

NOTE:
Static Strength Rating 1500 lb.
Dynamic Strength Rating 70ft.-lb.
Endurance Rating 250,000 c.

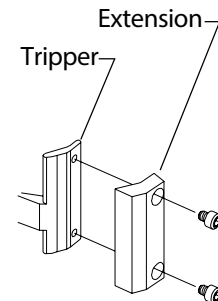
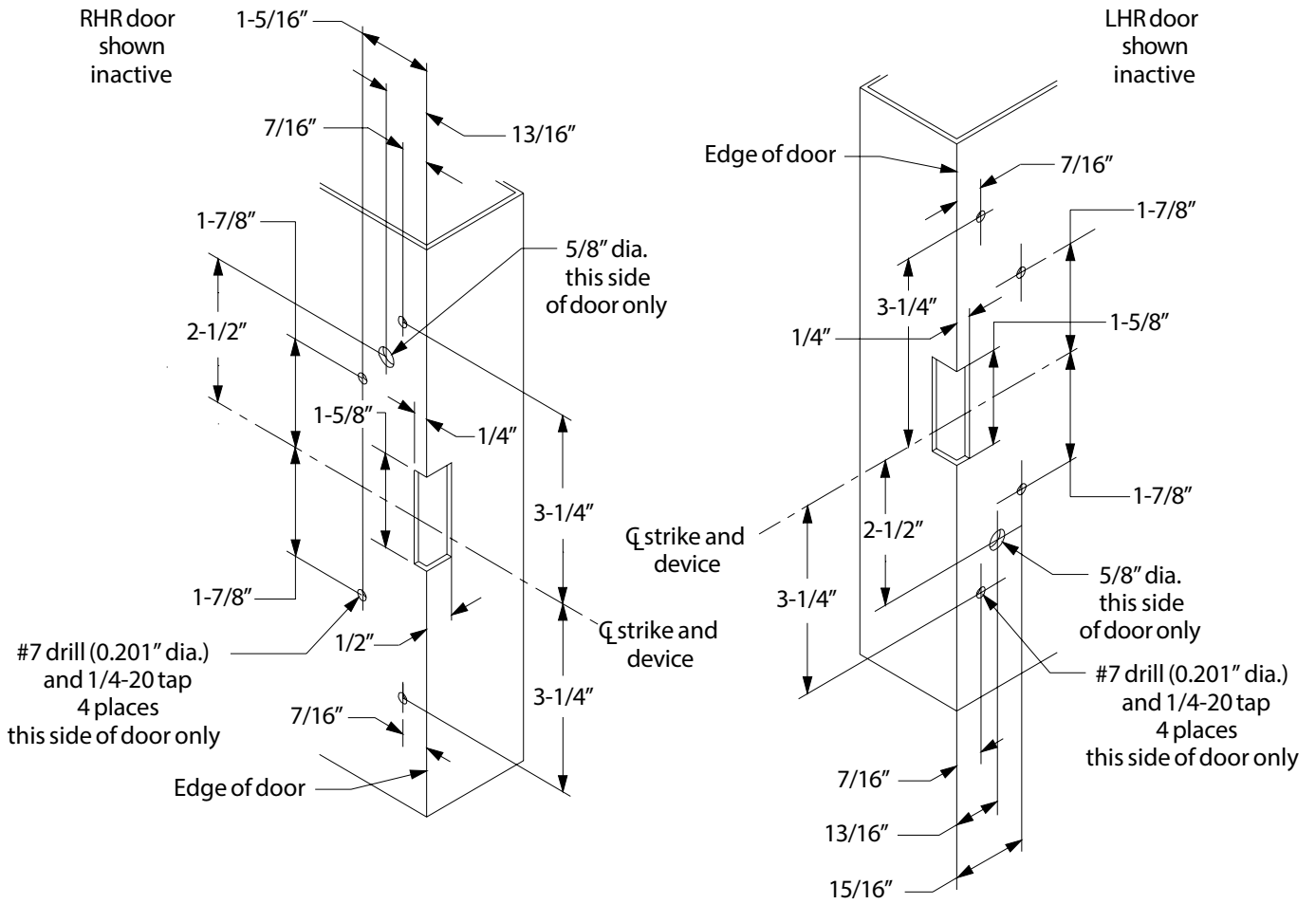

Figure 4



Customer Service
 1-877-671-7011 www.allegion.com/us

© Allegion 2014
Printed in U.S.A.
931239-00 Rev. 01/14-b



Door Preparation for Strike

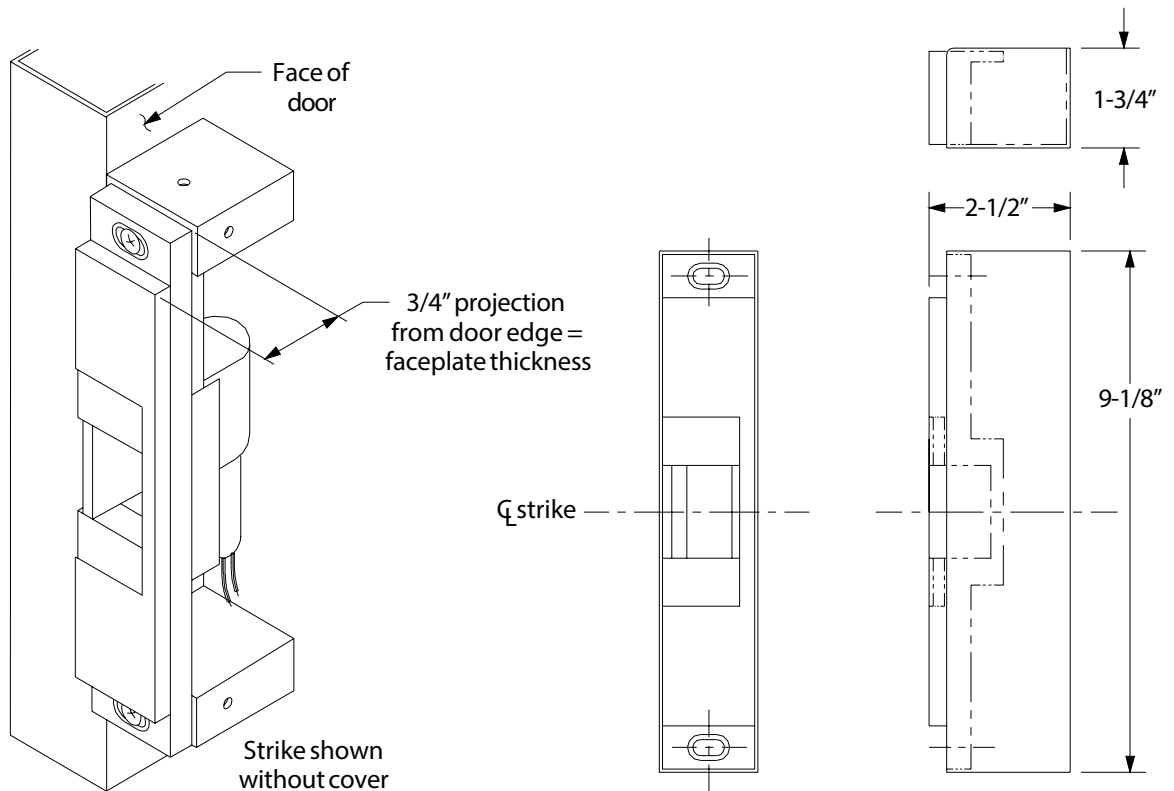

Strike Dimensions and Required Clearances