

VON DUPRIN®

6300 Series

Surface mounted strike for rim exit devices



Overview

Von Duprin electric strikes are known for their reliability, durability and security. The 6300 Series strike is designed to withstand abuse. Its heavy-duty stainless steel construction is fully UL1034 and UL10C listed and meets ANSI/BHMA Grade 1.

The 6300 Series strike is designed for use with a variety of rim exit devices. As an electrified strike, it allows remote release of a locked door by activating a movable lip (keeper) using an entry/exit button or credential reader and can be a cost effective means for managing access. It is ideal for aftermarket applications and designed to install without modifying or altering the door frame.

Designed for fail-secure (FSE) only mode, the 6300 Series strike achieves compliance with UL10C for 3-hour fire-rated openings. It also enables field-selectable 12 or 24 VDC with AC conversion optional.

To assure the proper selection of an electric strike on new applications, lockset compatibility charts are shown on the next page. When using a lockset not listed or when retrofitting a strike to an existing application, please contact Von Duprin Technical Support for application assistance.

Features and benefits

- Designed for use with rim exit devices
- Heavy-duty stainless steel construction in BHMA 630 satin finish
- Surface mounted - requires no alteration or cutting to existing frame
- Field selectable voltage 12VDC or 24VDC
- Plug-in voltage connectors included for ease of installation and removal during strike servicing
- Non-handed design provides greater flexibility
- Suitable for interior and exterior doors
- UL10C 3-hour fire-rated (fail secure only)
- UL 1034 listed for burglary-resistant electric door strikes
- Meets ANSI/BHMA A156.31, Grade 1 for endurance and dynamic strength
- Meets ANSI/BHMA A156.31, Grade 1, 1500 lbs static strength
- Dynamic strength 70 ft-lbs
- Endurance 2,000,000 cycles

6300 Series power requirements

Model	Voltage	Current	Duty	Amps	Ohms
6300	12V	DC	Continuous	0.50	22
6300	24V	DC	Continuous	0.24	89

Continuous duty = Energized 1 minute or more

Rim exit device compatibility 6300 strikes

Manufacturer	Model Number
Von Duprin	VD 22/22-F Rim
Von Duprin	VD 33A/35A Rim
Von Duprin	VD 55 Rim
Von Duprin	VD 88/88-F Rim device
Von Duprin	VD 98/99 and 98/99-F Rim
Falcon	Falcon 24/24-F Rim
Falcon	Falcon 25/25-F Rim
Falcon	Falcon 19/19-F Rim
Falcon Doromatic	Falcon Doromatic 1790
Falcon Doromatic	Falcon Doromatic 2090

Model specifications

Model number	6300
Retrofits model	N/A
Latchbolt throw	3/4"
Face plate length	9"
Projection	3/4"
Lockset	Rim exit device
Number of doors	Single or pair with mullion
Door/frame type	Hollow metal, aluminum and wood
EB (entry buzzer)	Optional
Certifications	UL1034, UL10C
Application notes	Surface mounted electric strike ideal for aftermarket applications. Strike designed for use with Von Duprin 98/99, however it can be used with most rim exit devices.

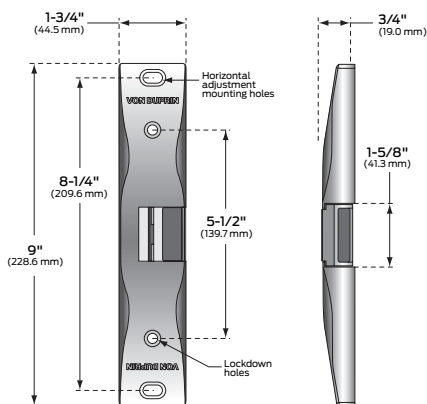

About Allegion

Allegion (NYSE: ALLE) is a global pioneer in safety and security, with leading brands like CISA®, Interflex®, LCN®, Schlage® and Von Duprin®. Focusing on security around the door and adjacent areas, Allegion produces a range of solutions for homes, businesses, schools and other institutions. Allegion is a \$2 billion company, with products sold in almost 130 countries. For more, visit www.allegion.com.

aptiQ ■ LCN ■ SCHLAGE ■ STEELCRAFT ■ VON DUPRIN

AC

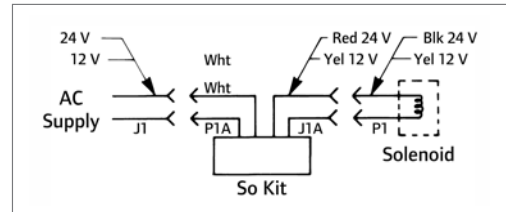

AC with buzzer

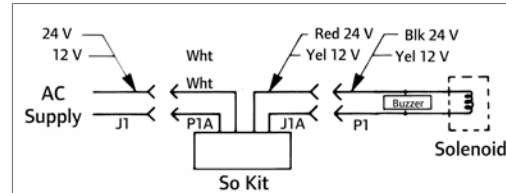

DC

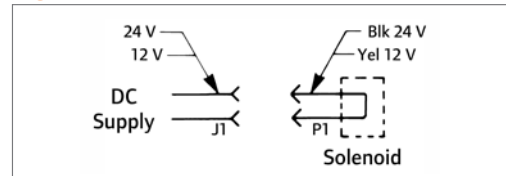

DC with Buzzer

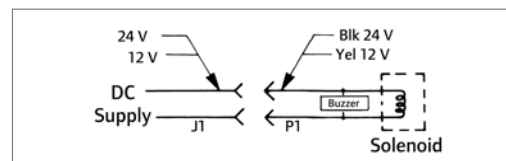

Ordering information

6300-S024-EB

Model	Rectifier kit*	Buzzer*
1	2	3

* Optional

Selections correspond with the numbers above

1	Model
6300	Surface mounted strike for rim exit devices
2	Rectifier kit (optional)
S012	Converts 12 VAC voltage to 12 VDC to operate the solenoid
S024	Converts 24 VAC voltage to 24 VDC to operate the solenoid
3	Buzzer (optional)
EB	Entry buzzer

Standard features

- Power failure mode: Fail-secure only (FSE)
- Voltage: field selectable 24 VDC or 12 VDC
- Finish: stainless steel, satin (BHMA 630/US32D)



© 2015 Allegion
003242, Rev. 08/15
www.allegion.com/us