

Architectural Door Accessories

ASSA ABLOY

Experience a safer
and more open world

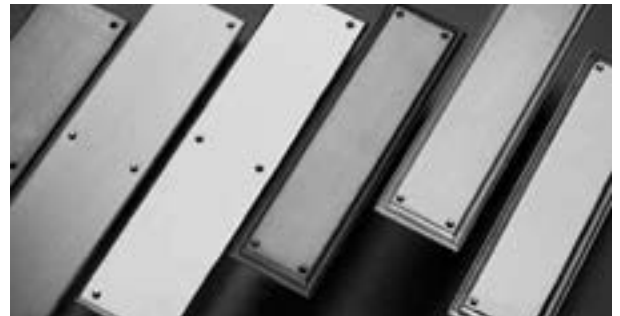
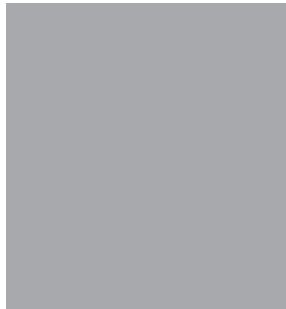
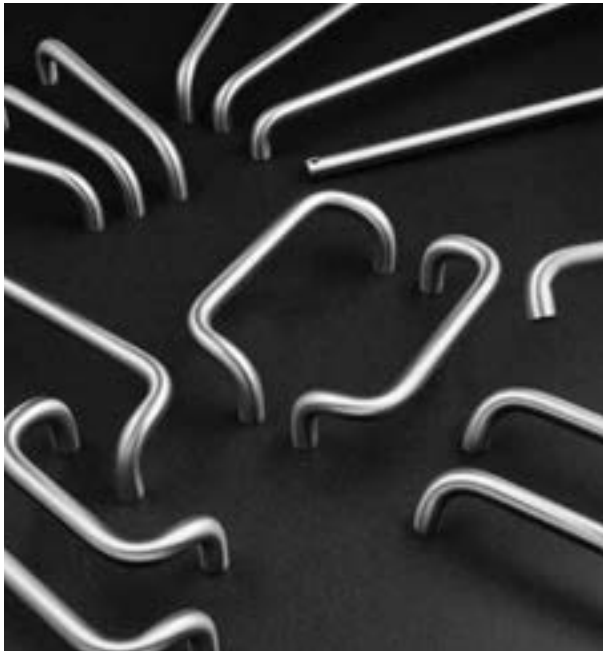
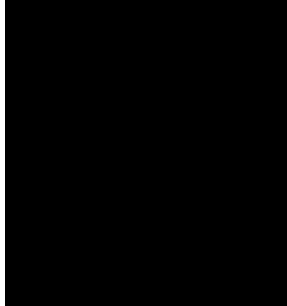
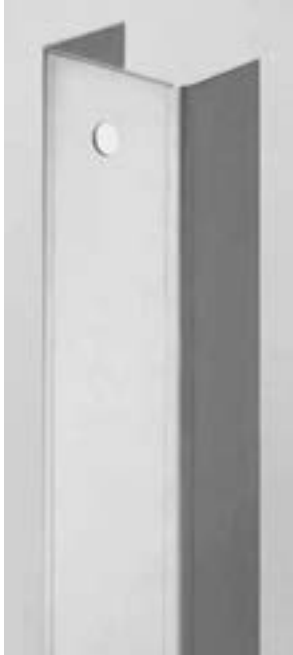

Rockwood Products Price Book - Accessories

USA & Canada Prices Effective March 16, 2020

Table of Contents	Page #
Architectural Finishes	33
Angle Plates	29
Auxiliary Hardware	27
Card Holder	25
Coordinators	27
Corner Guards	21
Covers	28
Custom Strikes	29
Decals	25
Door Edges	21-22
Door Guards	25
Door Knockers & Viewers	25
Door Plates - Kick Plates/Armor Plates	30-32
Door Pulls	16-20
Door Silencers	25
Door Stops	23-24
Fasteners - Spare Parts	38-41
Filler Plates & Shims	29
Flush Bolts	27
Flush Bolts - Manual	24
Flush Pulls	15
Gate Latch	24
Gravity Door Coordinators	24
General Information	8
Latch Protectors	22
Mounting Details	34-37
Mounting Kits	42
Numeric Index	4-7
Overhead Holders & Stops	28
Pivots	29
Privacy Door Latch	25
Pull Plate Sets	14
Pull Plates	20-21
Push and Pull Bars	9
Push Plate Ordering Information	12
Push Plates	13-15
Roller Latches	24
Series 47 Push Bars	10
Series 47 Tubular Push & Pull Bars	11
Signs	26
Surface Bolts	24-25
Trim Protector Bars	29
Vandal Resistant Trim & Vandal Resistant Pulls	20
Wall Guard	25

No.	Description	Page	No.	Description	Page
10-PB	Push Bar	9	96	Flush Pull	15
10BO	Bracket for #10	9	102-RKW	Straight Door Pull	16
11-PB – 18-PB	Push Bars	9	102 x 70	Pull Plates	20
19-PB	Push Bar	9	105	Straight Door Pull	16
20-PB – 23-PB	Pull Bars	9	105 x 70	Pull Plates	20
25-PB – 26-PB	Push Bars	9	106-RKW	Straight Door Pull	16
27-PB – 30-PB	Push Pull Bar Sets	9	106 x 70	Pull Plates	20
31-PB – 32-PB	Pull Bars	9	107	Straight Door Pull	16
33-PB – 34-PB	Push Bars	9	107 x 70	Pull Plates	20
35-PB – 36-PB	Push Pull Bar Sets	9	107 x 73B/73BL	Pull Plate Set	14
40-PB – 42-PB	Screen Door Guards	9	108 – 110-RKW	Straight Door Pull	16
43-PB – 45-PB	Push Bars	9	110 x 70	Pull Plates	20
47-PB, -2-PB, -3-PB	Series 47 Push Bars	10	110 x 73C/73CL	Pull Plate Set	14
48-PB	Series 47 Push Bar	10	110-6SP	Security Door Pull	16
50-PB	Pull Bar	9	111, 111A	Straight Door Pull	16
51-PB	Push Bar	9	111 x 70	Pull Plates	20
51BO	Bracket for #50	9	111 x 73C/73CL	Pull Plate Set	14
52-PB	Push Pull Bar Set	9	112	Straight Door Pull	16
53-PB	Push Pull Bar Set	9	118	Straight Door Pull	16
70 Series	Push Plates - .050" Thick	13	120 – 122-RKW	Door Pulls	17
71 Series	Push Plates - .062" Thick	13	122 x 70	Pull Plates	20
73 Series	Push Plates - .125" Thick	14	123	Door Pull	17
75 Series	Push Plates - .125" Thick	14	123 x 70	Pull Plates	20
76 Series	Decorative Push Plates - .050" Thick	14	125-RKW	Door Pull	17
77 Series	Decorative Push Plates - .050" Thick	14	125 x 70	Pull Plates	20
80 – 86	Push Plates - .050" Thick	15	126-RKW	Door Pull	17
87	Push Plate - .125" Thick	15	126 x 70	Pull Plates	20
90, 90B	Cylinder Pulls	15	130-RKW – 132-RKW	Cast Door Pulls	17
91-RKW – 93-RKW	Combination Push Pull Plates	15	132 x 70	Pull Plates	20
94, 94BTB	Flush Pulls	15	134-RKW – 137	Cast Door Pulls	17
94C	Flush Pull	15	137 x 70	Pull Plates	20
94DLL, 94DLS	Dead Lock Flush Pulls	15	138 – 139	Cast Door Pulls	17
94L, 94P	Flush Pulls	15	147, 147L	Cast Door Pulls	17
94P x 94L	Flush Pull Set	15	147 x 76, 77	Decorative Pull Plates	21
95A, 95B	Flush Pulls	15	148	Cast Door Pull	17
95R	Flush Pull - Round	15	148 x 76, 77	Decorative Pull Plates	21

ASSA ABLOY

Experience a safer
and more open world

No.	Description	Page	No.	Description	Page
149	Cast Door Pull.....	17	488 – 489	Door Stops.....	24
176-RKW – 177	Offset Door Pulls.....	19	490	Door Holder & Stop.....	24
185	Offset Door Pull.....	19	491-RKW – 494S	Automatic Door Holders & Stops.....	24
193	Hospital Door Pull.....	19	505-RKW – 508	Cast Brass Door Stops.....	24
208	Wooden Door Pull.....	19	517	Aluminum Door Stop.....	24
215, 215L	Tapered Door Pulls.....	19	518 – 519	Cast Brass Door Stops.....	24
290 – 296	Corner Guards.....	21	520	Replacement Bumper.....	24
300 – 302B	Mortise Door Edges.....	21	525 – 526	Spring Base Door Stops.....	24
304 – 307	Non-Mortise Door Edges.....	22	528	Hinge Pin Stop.....	24
308 – 310B-BS	Overlapping Door Edges.....	22	550 Series	Lever Ext. Flush Bolt, Guide & Strike.....	24
320-RKW – 330	Latch Protectors.....	22	554 Series	Rabbit Piece, Guide & Strike.....	24
400 – 405	Solid Cast Wall Stops.....	23	555 Series	Lever Ext. Flush Bolt, Bolt Head, Guide & Strike.....	24
406 – 409	Wrought Wall Stops.....	23	555ROD	Optional Bolt Lengths.....	24
412 – 416	Solid Cast Wall Stops.....	23	555 x BFB	Flush Bolt w/Bottom Fire Bolt.....	24
426	Wall Stop.....	23	556WS	Lever Ext. Wind Storm Flush Bolt.....	24
430-RKW	Solid Cast Wall Stop.....	23	557 Series	Lever Ext. Flush Bolt & Strike.....	24
431-RKW, 432W	Wall Stops.....	23	570	Dust Proof Strike.....	24
440 – 441	Low Dome Stops.....	23	576, 576B	Gravity Door Coordinator.....	24
441CU	Dome Stop Combination Unit.....	23	580 Series	Surface Bolts.....	24
441H	Cast Universal Dome Stop.....	23	582 Series	Surface Bolts.....	24
442 – 443	High Dome Stops.....	23	585 Series	Heavy Duty Surface Bolts.....	24
444	Cast Door Stop Riser.....	23	590 – 594	Roller Latches.....	24
445, 445H	Heavy Duty Door Stops.....	23	602	Secret Gate Latch.....	24
446	Door Stop.....	23	603 – 604 Shim	Door Guards w/Shim.....	25
449	Door Stop Riser.....	23	605, 605SMS	Door Guard Protection Plates.....	25
455	Curved Roller Stop.....	23	606-RKW	Wall Guard.....	25
456-RKW, 456L	Straight Roller Stops.....	23	PDL	Privacy Door Latch.....	25
458	Kick Down Door Stop.....	23	608-RKW – 609	Door Silencers.....	25
459	Spring Loaded Plunger Stop.....	23	611	Door Knocker.....	25
460 – 461L	Kick Down Door Stops.....	23	614, 614V	Door Knockers.....	25
462 – 468-RKW	Heavy Duty Door Stops.....	23	619	160° Door Viewer.....	25
470 – 481	Door Stops.....	23	620	160° Door Viewer.....	25
481MP	Heavy Duty Mounting Plate.....	23	620VC	Viewer Cover for 619.....	25
482 – 485	Door Stops.....	23	621	160° Door Viewer.....	25
486	Angle Door Stop.....	23	622	190° Door Viewer.....	25
487	Heavy Duty Wall Stop.....	23			

No.	Description	Page	No.	Description	Page
622VC	Viewer Cover for 622	25	2960, 2962	Automatic Flush Bolts	27
624	160° Door Viewer w/Cover	25	11047, -2, -3	Straight Push Pull Bar Sets	10
626 – 629	190° Door Viewers w/Cover	25	11147, -2, -3	Straight Push Pull Bar Sets	10
630 Series	Surface Bolts	25	111A47, -2, -3	Straight Push Pull Bar Sets	10
651	Card Holder	25	11247, -2, -3	Straight Push Pull Bar Sets	10
660, 661, 662-RKW	Decals	25	11847	Straight Push Pull Bar Set	10
670 Series	Engraved Signs.....	26	BF97, BF97L	Barrier Free Flush Pulls.....	15
674H, 674L	Engraved Signs.....	26	BF150 – BF159	90° Offset Door Pulls	18
700 – 702	Hand Rail Brackets.....	27	BF156 – BF159 C17	90° Offset Door Pull Sets.....	18
790	Small Coat Hook.....	27	BF160 – BF169	45° Offset Door Pulls	19
796	Small Double Coat Hook.....	27	BF257 – BF260	Heavy Duty Offset Door Pulls.....	20
802, 806	Medium Coat Hooks.....	27	BF680 Series	Engraved Signs w/Braille.....	26
841	Ball Knob.....	27	BF683 – BF689	ADA Tactile Signs w/Braille	26
845	Utility Pull	27	BF15647, -2, -3	Offset Push Pull Bar Sets.....	10
850 – 856-RKW	Wire Pulls.....	27	BF15747, -2, -3	Offset Push Pull Bar Sets.....	10
860	Flush Cup Pull.....	27	BF157A47, -2, -3	Offset Push Pull Bar Sets.....	10
870	Wrought Flush Pull	27	BF15847, -2, -3	Offset Push Pull Bar Sets.....	10
872	Cast Flush Pull	27	BF15947	Offset Push Pull Bar Set	10
880	Cast Lever Edge Pull.....	27	BFLG10 – BFLG16	Latch Guard Covers	28
885-RKW	Concealed Edge Pull.....	27	BFM624, BFM625	All Gender Restroom Signs	26
890 – 891	Pocket Door Pulls	27	BFM682 – BFM689	Tactile ADA Molded Plastic Signs w/Braille.....	26
900 – 901	Magnetic Catches.....	27	BFRC12, BFRC24	Vertical Rod Covers	28
910 – 911	Adjustable Ball Catches	27	BP47, -2, -3	Series 47 Push Bars w/Base Plate.....	10
1100	Carry Bar	27	CP10 – CP10HD	Pivots - Standard Head	29
1700	Door Coordinator	27	CP40 – CP40HD	Pivots - Standard Floor	29
2600 Series	Door Coordinators	27	CPK2840	Cover Plate Kit	27
2805	Self Latching Flush Bolt (Top Only).....	27	CS Series	Custom Strikes	29
2840, 2842	Automatic Flush Bolt Sets.....	27	D89	Security Flush Pull	15
2845	Combination Flush Bolt Set	27	D133-RKW	Security Loop Door Pull.....	17
2848, 2849	Flush Bolts w/Bottom Fire Bolt	27	DF86	Door Edge Filler Plate.....	29
2905	Self Latching Flush Bolt (Top Only).....	27	DFF4	Frame Hinge Filler Plates	29
2940, 2942	Automatic Flush Bolt Set.....	27	DFF5	Frame Hinge Filler Plates	29
2945	Combination Flush Bolt Set	27	DHF4B	Door Hinge Filler Plates	29
2948, 2949	Flush Bolts w/Bottom Fire Bolt	27			

No.	Description	Page	No.	Description	Page
DHF4S	Door Hinge Filler Plates	29	R101LPB	Trim Protector Bars.....	29
DHF5B	Door Hinge Filler Plates	29	R102LPB	Trim Protector Bars.....	29
DHF5S	Door Hinge Filler Plates	29	R111LPB	Trim Protector Bars.....	29
FB-1, -2	Filler Bars.....	27	R112LPB	Trim Protector Bars.....	29
FBF48	Flush Bolt Filler Plate	29	R115LPB	Trim Protector Bars.....	29
FBS48	Flush Bolt Strike Filler Plate	29	R116EDPH	Exit Device Protector	29
FC161	Door Face Filler Plate.....	29	R116EDPL	Exit Device Protector	29
FD160	Door Face Filler Plate.....	29	SD1230	Standard Duty Trim Protector Bar.....	29
HD2230	Heavy Duty Trim Protector Bars	29	SD1240	Standard Duty Trim Protector Bar.....	29
HD2240	Heavy Duty Trim Protector Bars	29	SD1250	Standard Duty Trim Protector Bar.....	29
HD2250	Heavy Duty Trim Protector Bars	29	SD1260	Standard Duty Trim Protector Bar.....	29
HS42	4 Hinge Shims	29	SF160	Strike Filler Plate	29
HS44	4 1/2" Hinge Shims	29	SFASA	Strike Filler Plate	29
HS52	5" Hinge Shims	29	SFB160	Strike Filler Plate	29
HS54	5" Hinge Shims	29	SP47	Series 47 Push Bar	10
K1038	Metal Door Plate - .038" Thick.....	31	SP1001 – SP1079	Fasteners - Spare Parts	38-41
K1050, K1050F	Metal Door Plates - .050" Thick.....	31	T47, -2, -3	Tubular Push Bars	11
K1050-1 – K1050-8	Shaped Metal Door Plates - .050" Thick.....	31	T110 – T118	Tubular Door Pulls	16
K1050A-1 – K1050A-8	Shaped Metal Door Plates - .050" Thick.....	31	T110 x 70	Tubular Pull Plates	21
K1062	Metal Door Plate - .062" Thick.....	31	T111 x 70	Tubular Pull Plates	21
K1125	Metal Door Plate - .125" Thick.....	31	T11047	Tubular Straight Push Pull Bar Sets.....	11
K2060 Series	Plastic Door Plates - .060" Thick.....	31	T11147	Tubular Straight Push Pull Bar Sets.....	11
K2125 Series	Plastic Door Plates - .125" Thick.....	31	T111A47	Tubular Straight Push Pull Bar Sets.....	11
K3125	Laminate Plastic Door Plate - .125" Thick.....	31	T11247	Tubular Straight Push Pull Bar Sets.....	11
K4125	Clear Plastic Door Plate - .125" Thick.....	31	T11847	Tubular Straight Push Pull Bar Set.....	11
KB1150 – KB1152	Angle Plates - .050" Thick	29	TBF156 – TBF159	Tubular 90° Offset Door Pulls	18
KIT Series	Mounting Kits for Door Pulls	42	TBF156 – TBF159 C17	Tubular 90° Offset Door Pull Sets	18
LA86	Latch Adapter Plate	29	TBF15647	Tubular Offset Push Pull Bar Sets.....	11
LF161	Door Edge Filler Plate.....	29	TBF15747	Tubular Offset Push Pull Bar Sets.....	11
OH100	HD Concealed Overhead Stops.....	28	TBF157A47	Tubular Offset Push Pull Bar Sets.....	11
OH200	Concealed Overhead Holders & Stops.....	28	TBF15847	Tubular Offset Push Pull Bar Sets.....	11
OH900	HD Surface Overhead Stops	28	TBF15947	Tubular Offset Push Pull Bar Set.....	11
OH1000	Surface Overhead Holders & Stops.....	28	VRP30	Vandal Resistant Pull.....	20
PDL	Privacy Door Latch.....	25	VRT12 – VRT26	Vandal Resistant Trim	20

Ordering Information

This price list cancels and supersedes all prior listings.

Orders are accepted with the understanding that they will be billed at prices in effect at time of shipment.

Prices are subject to change without notice.

We reserve the right to decline the whole or part of orders in which the price or quantity of goods is not acceptable to us.

Easy Order Placement

USA:

By Phone: 1-800-458-2424 Monday through Thursday 8:00 am ET to 7:30 pm ET, Friday 8:00 am ET to 4:30 pm ET

By Fax: Orders may be faxed to 1-800-922-9212

By Email: orders.rockwood@assaabloy.com

By Internet: <http://extranet.assaabloydss.com/> and select Order Entry under the Customer Service Menu

Canada:

By Phone: 1-800-461-3007 Monday through Friday 8:00 am ET to 4:30 pm ET

By Fax: Orders may be faxed to 1-800-461-8989

By Email: cavau-orders@assaabloy.com

By Internet: <http://extranet.assaabloydss.ca/> and select Order Entry under the Customer Service Menu

Terms and Conditions of Sale

Terms: 1% 15 days, net 30 days

Remit Payment To: PNC Bank/Rockwood, PO Box 644489, Pittsburgh, PA 15264-4489

For Terms & Conditions and Warranty information pertaining to product sales in Canada, please visit www.assaabloy.ca/terms

Freight Policy

Freight Allowance: All prices are F.O.B. Rockwood, Pennsylvania and/or Ventura, California. Full freight will be allowed on shipments of \$1,000 net and over within the continental limits of the United States (excluding Alaska and Hawaii). All shipments are routed most cost effective route of our choice. We reserve the right to designate the carrier.

Special Order Material

Special items made to your specifications are not returnable. These items are not subject to cancellation without consideration of expense involved at the cancellation date.

Samples

Salable samples will be charged at regular prices.

Returned Goods

Return no merchandise without written permission from the factory. Authorization will insure your receiving proper credit. Errors in shipping may occasionally occur. If this is the case immediately notify the factory, and we will gladly make the proper adjustments. If the error is at the customer's end, a minimum charge of 25% plus freight will be incurred for handling. Unauthorized claims for labor or charges will not be allowed. No credit will be allowed beyond six months after invoice date.

Shortages

Claims for shortages must be made within 30 days of invoice date.

Templates

Upon request we will furnish templates for any of our standard items of manufacture. Commonly used templates are available on our website at www.assaabloydooraccessories.us.

Product Weight Information

NOTE: Weights indicated throughout the price list are approximate for brass, bronze or stainless steel base material. Aluminum base materials weigh approximately $\frac{1}{3}$ the listed weights.

Engraving

Engraving may be added on many pulls and plates. Call factory for pricing.

For Terms and Conditions as well as Warranty information pertaining to product sales in Canada, please visit www.assaabloy.ca/terms

ASSA ABLOY

Experience a safer
and more open world

Push and Pull Bars

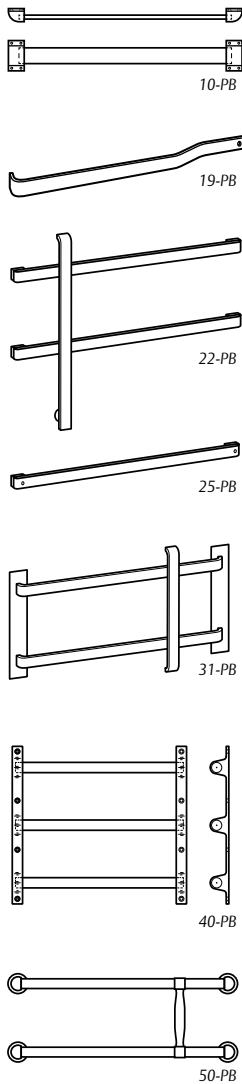

Push and Pull Bars							
Part	28/628	3/605 4/606	10/612 10B/613	10BE/BSP	26/625 26D/626	32D/630	32DMS
10-PB		863.00	863.00	856.00	833.00		
10BO		273.00	273.00	275.00	265.00		
11-PB	342.00	710.00	811.00	434.00	785.00	368.00	391.00
12-PB	342.00	710.00	811.00	434.00	785.00	368.00	391.00
14-PB	342.00	811.00	909.00	475.00	882.00	398.00	425.00
15-PB	342.00	811.00	909.00	475.00	882.00	398.00	425.00
18-PB	342.00	811.00	909.00	475.00	882.00	398.00	425.00
19-PB	342.00	811.00	909.00	475.00	882.00	398.00	425.00
20-PB	836.00	1,867.00	2,172.00	1,041.00	2,103.00	877.00	900.00
21-PB	947.00	2,015.00	2,471.00	1,160.00	2,398.00	974.00	1,003.00
22-PB	963.00	2,118.00	2,417.00	1,200.00	2,346.00	1,009.00	1,033.00
23-PB	1,023.00	2,273.00	2,722.00	1,261.00	2,643.00	1,059.00	1,084.00
25-PB	329.00	710.00	811.00	376.00	785.00	314.00	339.00
26-PB	342.00	760.00	909.00	394.00	882.00	330.00	358.00
27-PB	1,475.00	3,275.00	3,778.00	1,792.00	3,665.00	1,505.00	1,528.00
28-PB	1,626.00	3,527.00	4,285.00	1,946.00	4,159.00	1,583.00	1,660.00
29-PB	1,608.00	3,679.00	4,029.00	1,946.00	3,908.00	1,632.00	1,660.00
30-PB	1,701.00	3,778.00	4,536.00	1,599.00	4,399.00	1,717.00	1,741.00
31-PB	838.00	2,008.00	2,242.00	1,301.00	2,176.00	1,090.00	1,118.00
32-PB	883.00	2,047.00	2,296.00	1,334.00	2,227.00	1,118.00	1,145.00
33-PB	727.00	1,594.00	1,786.00	1,017.00	1,735.00	852.00	881.00
34-PB	770.00	1,655.00	1,855.00	1,049.00	1,798.00	881.00	907.00
35-PB	1,242.00	3,600.00	4,021.00	2,319.00	3,904.00	1,947.00	1,970.00
36-PB	1,275.00	3,699.00	4,140.00	2,382.00	4,047.00	1,995.00	2,023.00
40-PB		748.00	748.00	667.00	724.00		
41-PB		529.00	529.00	473.00	512.00		
42-PB		383.00	383.00	341.00	370.00		
43-PB	389.00	1,187.00	1,420.00	841.00	1,377.00	705.00	732.00
44-PB	360.00	1,109.00	1,331.00	793.00	1,291.00	665.00	691.00
45-PB	338.00	1,007.00	1,206.00	748.00	1,169.00	630.00	653.00
50-PB		991.00	1,084.00	969.00	1,050.00		
51-PB		398.00	437.00	392.00	422.00		
51BO		77.00	85.00	78.00	83.00		
52-PB		1,772.00	1,946.00	1,739.00	1,891.00		
53-PB		338.00	379.00	341.00	368.00		

Push & Pull Extra Length Bars

Extra Length Bars						
Description	28/628	3/605 4/606	10/612 10B/613	10BE/BSP	26/625 26D/626	32D/630
Over 3/4" thru 1 1/2"	6.60	13.00	15.30	15.30	13.00	10.90
Over 1 1/2" thru 3"	8.70	17.40	19.60	21.20	17.40	15.30

Bars over 36" add per inch the following additional cost.

Mounting Types for Push Bars 10 through 45 and 50, 51, 52

Mounting charge included in list price.

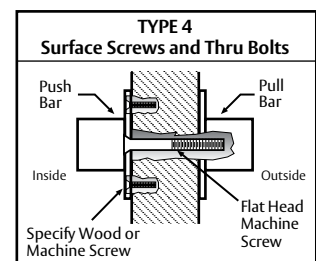
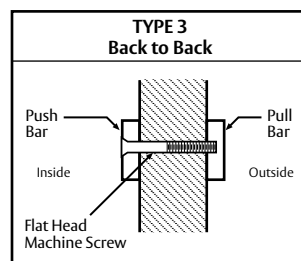
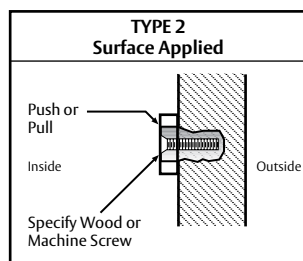
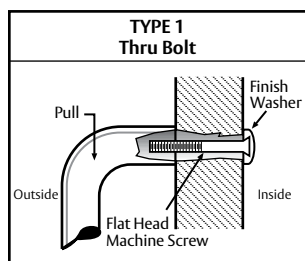

ASSA ABLOY

Series 47 Push Bars

Series 47 Push Bars												
Part	28/628	313/710 314 315/711	3/605 4/606	10/612 108/613	10BE/BSP	26D/626	26/625	32D/630	32/629	32DMS	32D316	32316
SP47	189.00	228.00	582.00	728.00	599.00	560.00	560.00	509.00	570.00	538.00	699.00	752.00
47-PB	115.00	129.00	459.00	602.00	543.00	453.00	471.00	308.00	354.00	544.00	706.00	740.00
47-2-PB	318.00	389.00	1,094.00	1,094.00	1,105.00	1,060.00	1,060.00	907.00	1,021.00	1,033.00	1,301.00	1,365.00
47-3-PB	474.00	474.00	1,640.00	1,640.00	1,653.00	1,592.00	1,592.00	1,361.00	1,530.00	1,549.00	1,949.00	2,048.00
48-PB	160.00	189.00	431.00	509.00	348.00	417.00	417.00	277.00	358.00	374.00	418.00	478.00
BP47	254.00	287.00	641.00	641.00	640.00	621.00	621.00	551.00	595.00	576.00	750.00	780.00
BP47-2	509.00	575.00	1,373.00	1,373.00	1,376.00	1,331.00	1,331.00	1,183.00	1,276.00	1,286.00	1,584.00	1,648.00
BP47-3	665.00	768.00	1,946.00	1,946.00	1,958.00	1,891.00	1,891.00	1,677.00	1,813.00	1,832.00	2,269.00	2,365.00
Straight Single Bar Sets												
11047	180.00	208.00	630.00	800.00	729.00	628.00	644.00	424.00	496.00	730.00	958.00	1,026.00
111A47	248.00	290.00	827.00	920.00	797.00	798.00	798.00	665.00	740.00	736.00	971.00	1,038.00
11147	184.00	210.00	650.00	827.00	751.00	642.00	664.00	436.00	509.00	756.00	870.00	988.00
11247	186.00	212.00	668.00	856.00	775.00	664.00	684.00	446.00	522.00	774.00	1,018.00	1,089.00
11847	257.00	309.00	916.00	1,011.00	853.00	888.00	888.00	728.00	803.00	799.00	1,036.00	1,095.00
Straight Double Bar Sets												
11047-2	276.00	313.00	1,014.00	2,026.00	1,287.00	1,026.00	1,039.00	1,179.00	1,297.00	1,206.00	1,533.00	1,625.00
111A47-2	335.00	392.00	1,196.00	2,132.00	1,294.00	1,169.00	1,181.00	1,399.00	1,539.00	1,214.00	1,545.00	1,636.00
11147-2	497.00	571.00	1,819.00	2,049.00	1,314.00	1,800.00	1,855.00	1,193.00	1,311.00	1,234.00	1,453.00	1,592.00
11247-2	281.00	320.00	1,053.00	2,075.00	1,331.00	1,041.00	1,073.00	1,204.00	1,324.00	1,251.00	1,592.00	1,685.00
Straight Triple Bar Sets												
11047-3	382.00	432.00	1,435.00	3,290.00	1,833.00	1,443.00	1,466.00	1,947.00	1,801.00	1,721.00	2,179.00	2,303.00
111A47-3	441.00	510.00	1,618.00	3,393.00	1,838.00	1,585.00	1,610.00	2,163.00	2,031.00	1,725.00	2,192.00	2,312.00
11147-3	604.00	686.00	2,239.00	3,317.00	1,858.00	2,220.00	2,284.00	1,955.00	1,814.00	1,745.00	2,100.00	2,268.00
11247-3	387.00	436.00	1,469.00	3,339.00	1,877.00	1,460.00	1,502.00	1,970.00	1,827.00	1,762.00	2,240.00	2,363.00
Offset Single Bar Sets												
BF15647	210.00	238.00	714.00	920.00	828.00	717.00	738.00	469.00	546.00	803.00	1,095.00	1,166.00
BF157A47	212.00	240.00	734.00	949.00	848.00	736.00	755.00	483.00	567.00	814.00	1,111.00	1,182.00
BF15747	212.00	240.00	734.00	949.00	853.00	736.00	755.00	483.00	567.00	814.00	1,111.00	1,182.00
BF15847	214.00	243.00	753.00	975.00	877.00	753.00	776.00	496.00	579.00	853.00	1,157.00	1,229.00
BF15947	333.00	390.00	978.00	1,035.00	932.00	949.00	949.00	799.00	864.00	873.00	1,159.00	1,226.00
Offset Double Bar Sets												
BF15647-2	305.00	344.00	1,100.00	2,145.00	1,362.00	1,097.00	1,131.00	1,248.00	1,373.00	1,276.00	1,665.00	1,758.00
BF157A47-2	305.00	344.00	1,100.00	2,145.00	1,373.00	1,097.00	1,131.00	1,248.00	1,373.00	1,287.00	1,678.00	1,769.00
BF15747-2	305.00	344.00	1,100.00	2,145.00	1,391.00	1,097.00	1,131.00	1,248.00	1,373.00	1,287.00	1,678.00	1,769.00
BF15847-2	309.00	348.00	1,119.00	2,170.00	1,408.00	1,138.00	1,148.00	1,260.00	1,386.00	1,322.00	1,716.00	1,815.00
Offset Triple Bar Sets												
BF15647-3	410.00	462.00	1,522.00	3,409.00	1,907.00	1,515.00	1,562.00	2,022.00	2,242.00	1,790.00	2,310.00	2,436.00
BF157A47-3	410.00	462.00	1,522.00	3,409.00	1,920.00	1,515.00	1,562.00	2,022.00	2,224.00	1,801.00	2,323.00	2,445.00
BF15747-3	410.00	462.00	1,522.00	3,409.00	1,932.00	1,515.00	1,562.00	2,022.00	2,224.00	1,801.00	2,323.00	2,445.00
BF15847-3	412.00	465.00	1,540.00	3,434.00	1,954.00	1,556.00	1,579.00	2,031.00	2,234.00	1,835.00	2,365.00	2,492.00
Series 47 Extra Length Bars - Bars over 36" add per inch the following additional cost per bar.												
	4.80	6.10	12.50	16.50	14.30	12.20	12.50	12.50	9.60	14.30	14.30	14.30



47-PB

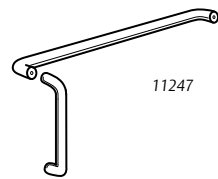

11247

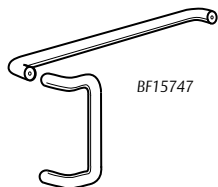

BF15747

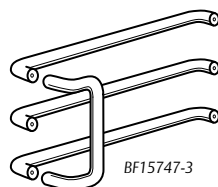

BF15747-3

See page 35 for detailed mounting drawings. Engraving "Push" or "Pull" on 1" Series 47 Push Bars add \$204.00 (1/2" Letter Height).

Series 47 Tubular Push & Pull Bars

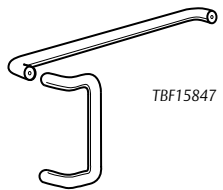
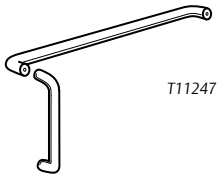

Series 47 Tubular Push Bars						
Part	3/605 4/606	10/612 10B/613	10BE/BSP	32D/630	32/629	32DMS
T47	420.00	443.00	363.00	295.00	330.00	323.00
T47-2	831.00	884.00	721.00	584.00	660.00	616.00
T47-3	1,250.00	1,321.00	1,083.00	877.00	988.00	904.00
Series 47 Tubular Straight Single Bar Sets						
T11047	649.00	679.00	529.00	429.00	500.00	500.00
T111A47	638.00	674.00	551.00	426.00	496.00	496.00
T11147	638.00	674.00	526.00	426.00	496.00	496.00
T11247	652.00	686.00	531.00	431.00	500.00	500.00
T11847	686.00	710.00	561.00	455.00	530.00	526.00
Series 47 Tubular Offset Single Bar Sets						
TBF15647	695.00	722.00	541.00	442.00	544.00	504.00
TBF157A47	702.00	734.00	548.00	448.00	548.00	513.00
TBF15747	702.00	734.00	548.00	448.00	585.00	513.00
TBF15847	710.00	743.00	556.00	455.00	552.00	518.00
TBF15947	748.00	784.00	594.00	485.00	585.00	550.00

See page 35 for detailed mounting drawings. Engraving "Push" or "Pull" on 1" Series 47 Push Bars add \$204.00 (1/2" Letter Height).

TYPICAL MOUNTING

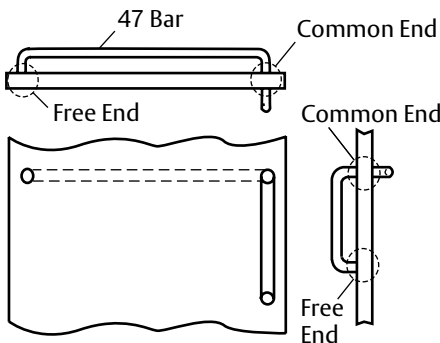

For Set Mounting Hardware, see page 34.

Location Standards

Positioning Applications:

- door pulls to plates
- engraving on plates
- cutouts on plates
- cutout and engraving on plates

Sizing:

- 1 1/4" standard cylinder hole cutout size
- 3/8" diameter standard thumbturn hole
- other cutout sizes and styles are readily available

NOTE: Be sure the pull you choose will fit on the plate, allowing for cutouts and/or engraving.

Pull Positioning on Plates 4" or Less in Width

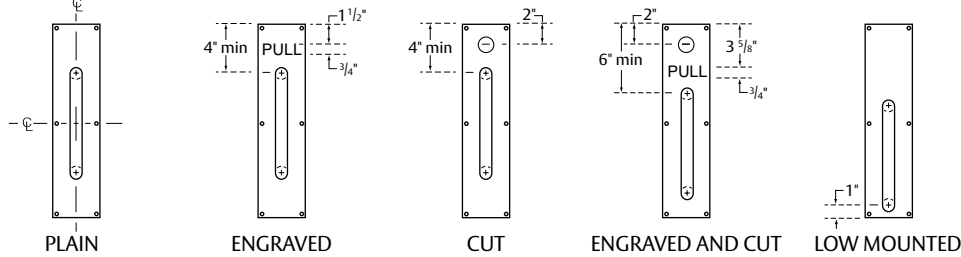

Pull Positioning on Plates Wider than 4" (Handing Required)

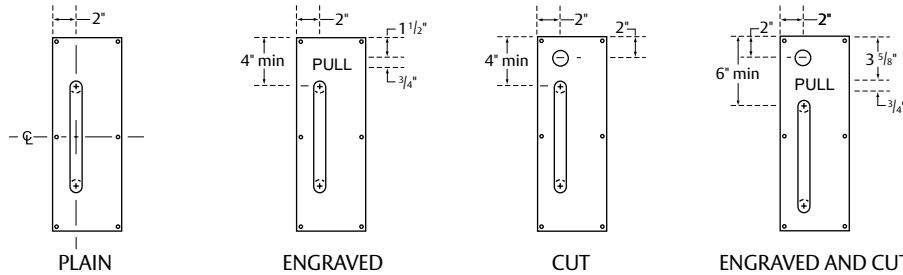

Recommended Locations on Door

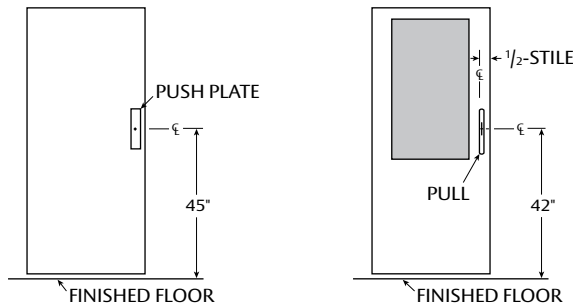

Engraving and Adhesive Mounting

Description	Price
Engraving "Push", "Pull", "Men" or "Women"	97.00
Push Plate Adhesive Mounting	19.40

Engraving: 3/4" high condensed block letters with black enamel fill; other letter sizes and styles are readily available.

Additional Charges Per Thickness of Push Plate

Part	Description	70/.050"	71/.062"	73/.125"
CFC	Cut for Cylinder	2.40	10.00	10.80
CFTT	Cut for Thumbturn	2.40	10.00	10.80
Pull Prep	Prep for Pull	4.80	20.00	21.60

Order form available when ordering.

ADA Accessibility Guidelines for Buildings and Facilities (ADAAG) as amended through January 1998 4.13.9 Door Hardware.

Handles, pulls, latches, locks, and other operating devices on accessible doors shall have a shape that is easy to grasp with one hand and does not require tight grasping, tight pinching, or twisting of the wrist to operate. Lever-operated mechanisms, push-type mechanisms, and U-shaped handles are acceptable designs. When sliding doors are fully open, operating hardware shall be exposed and usable from both sides. Hardware required for accessible door passage shall be mounted no higher than 48 in. (1220 mm) above finished floor.

Push Plates - .050" Thick

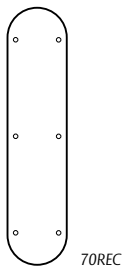
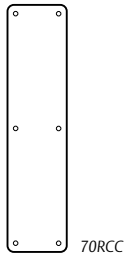
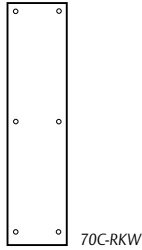

No. 70 - Square Ends										
Part	28/628	3/605 4/606	10/612 10B/613	10BE/BSP	26D/626	26/625	32D/630	32/629	32DMS	32D316
70A	19.40	38.40	43.10	38.70	38.40	40.70	15.30	24.10	41.70	53.00
70B	21.80	47.90	50.00	48.30	47.90	50.00	19.80	24.10	43.90	53.00
70C-RKW	26.60	55.00	60.00	53.00	55.00	58.00	19.50	28.50	48.30	58.00
70E	34.00	78.00	88.00	80.00	82.00	84.00	28.50	43.90	79.00	93.00
70F	38.80	106.00	112.00	107.00	108.00	110.00	41.70	55.00	88.00	112.00
70G	41.20	82.00	99.00	58.00	90.00	90.00	43.90	60.00	62.00	74.00

No. 70RC - Round Corners										
70RCA	41.20	65.00	67.00	43.30	65.00	65.00	32.90	43.90	48.30	60.00
70RCB	43.70	70.00	78.00	53.00	76.00	76.00	41.70	53.00	50.00	60.00
70RCC	43.70	78.00	88.00	58.00	86.00	86.00	46.00	57.00	53.00	65.00
70RCE	59.00	110.00	124.00	90.00	120.00	120.00	70.00	90.00	85.00	101.00
70RCF	63.00	126.00	151.00	96.00	146.00	146.00	77.00	99.00	92.00	114.00
70RCG	41.20	78.00	103.00	66.00	96.00	96.00	50.00	64.00	66.00	76.00

No. 70RE - Round Ends										
70REA	53.00	76.00	82.00	63.00	78.00	78.00	48.30	57.00	60.00	74.00
70REB	59.00	82.00	94.00	68.00	88.00	88.00	53.00	64.00	62.00	74.00
70REC	61.00	88.00	103.00	75.00	96.00	96.00	57.00	70.00	66.00	76.00

See page 12 for standard locations and sizes of Cylinder Cutouts (CFC) and Thumbturn Cutouts (CFTT), engraving and pricing.

Push Plates - .062" Thick

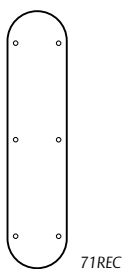
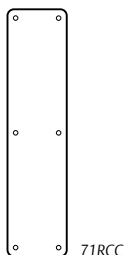
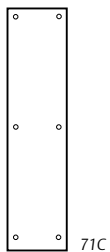

No. 71 - Square Corners			
Part	10BE/BSP	32D/630	32DMS
71A	55.00	44.00	70.00
71B	63.00	48.00	74.00
71C	72.00	55.00	83.00
71E	94.00	74.00	99.00
71F	111.00	85.00	112.00
71G	82.00	64.00	90.00

No. 71RC - Round Corners			
71RCA	68.00	53.00	79.00
71RCB	75.00	57.00	83.00
71RCC	82.00	64.00	90.00
71RCE	111.00	83.00	107.00
71RCF	118.00	90.00	118.00
71RCG	94.00	74.00	99.00

No. 71RE - Round Ends			
71REA	90.00	70.00	95.00
71REB	94.00	74.00	99.00
71REC	100.00	79.00	103.00

Concealed Mount Pull Plate Sets

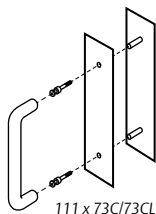

111 x 73C/73CL

Pull Plate x Plate with Lug			
Part	32D/630	32DMS	10BE/BSP
107 x 73B/73BL	351.00	402.00	424.00
110 x 73C/73CL	461.00	529.00	558.00
111 x 73C/73CL	477.00	549.00	577.00

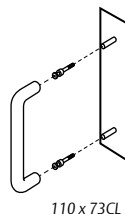

110 x 73CL

Pull (only) x Plate with Lug			
Part	32D/630	32DMS	10BE/BSP
107 x 73BL	246.00	281.00	298.00
110 x 73CL	343.00	395.00	415.00
111 x 73CL	365.00	421.00	445.00

See page 12 for standard locations and sizes of Cylinder Cutouts (CFC) and Thumbturn Cutouts (CFTT), engraving and pricing. See page 36 for detail drawing of Type 9 mounting.

Push Plates

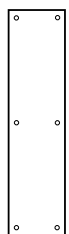

73C

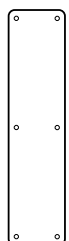

73RC

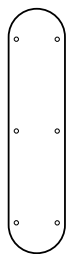

73RE

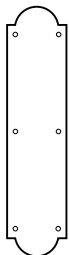

76C

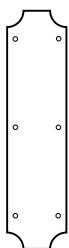

77C

No. 73 - Square Corners (.125" Thick)									
Part	28/628	3/605 4/606	10/612 10B/613	10BE/BSP	26/625 26D/626	32D/630	32/629	32DMS	32D316
73A	63.00	171.00	201.00	120.00	194.00	92.00	134.00	121.00	135.00
73B	77.00	192.00	220.00	135.00	213.00	64.00	142.00	130.00	153.00
73C	80.00	209.00	234.00	148.00	228.00	72.00	156.00	140.00	171.00
73E	94.00	270.00	297.00	197.00	285.00	151.00	191.00	178.00	234.00
73F	109.00	340.00	365.00	240.00	353.00	184.00	219.00	213.00	263.00
73G	82.00	243.00	270.00	160.00	263.00	125.00	173.00	149.00	187.00
No. 73RC - Round Corners (.125" Thick)									
73RCA	94.00	194.00	225.00	145.00	213.00	109.00	158.00	138.00	158.00
73RCB	100.00	207.00	237.00	154.00	230.00	121.00	163.00	145.00	167.00
73RCC	104.00	232.00	259.00	164.00	247.00	132.00	184.00	158.00	187.00
73RCE	124.00	293.00	319.00	222.00	308.00	171.00	221.00	198.00	259.00
73RCF	140.00	365.00	389.00	268.00	376.00	208.00	243.00	233.00	287.00
73RCG	112.00	263.00	293.00	184.00	283.00	142.00	200.00	169.00	209.00
No. 73RE - Round Ends (.125" Thick)									
73REA	138.00	234.00	263.00	190.00	257.00	147.00	193.00	173.00	196.00
73REB	151.00	247.00	276.00	199.00	266.00	153.00	200.00	180.00	206.00
73REC	153.00	263.00	287.00	212.00	279.00	165.00	215.00	191.00	225.00
Laminate and Clear Plastic - Square Corners (.125" Thick)									
Part	Black	Brown	Gray	Beige	Clear				
75A	32.00	32.00	32.00	32.00	32.00				
75B	34.50	34.50	34.50	34.50	34.50				
75C	34.50	34.50	34.50	34.50	36.90				
75E	41.80	41.80	41.80	41.80	44.40				
75F	46.80	46.80	46.80	46.80	49.20				
75G	39.30	39.30	39.30	39.30	41.80				
Decorative (.050" Thick)									
Part	3/605 4/606	10/612 10B/613	10BE/BSP	26/625 26D/626					
76B	96.00	108.00	100.00	103.00					
76C	106.00	114.00	109.00	110.00					
77B	96.00	108.00	100.00	103.00					
77C	106.00	114.00	109.00	110.00					

See page 12 for standard locations and sizes of Cylinder Cutouts (CFC) and Thumbturn Cutouts (CFTT), engraving and pricing.

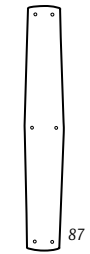
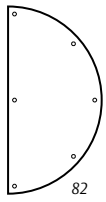

Push Plates (con't)

.050" Thick									
Part	28/628	3/605 4/606	10/612 10B/613	10BE/BSP	26/625 26D/626	32D/630	32/629	32DMS	32D316
80	94.00	153.00	169.00	113.00	162.00	85.00	112.00	105.00	139.00
81	100.00	160.00	173.00	123.00	169.00	95.00	125.00	147.00	148.00
82	104.00	171.00	189.00	133.00	182.00	101.00	132.00	125.00	155.00
84	163.00	270.00	290.00	225.00	281.00	173.00	204.00	193.00	229.00
85	61.00	112.00	114.00	80.00	110.00	70.00	70.00	90.00	101.00
86	88.00	133.00	139.00	111.00	133.00	83.00	83.00	103.00	120.00
.125" Thick									
87	155.00	315.00	338.00	264.00	326.00	204.00	243.00	228.00	283.00

See page 12 for standard locations and sizes of Cylinder Cutouts (CFC) and Thumbturn Cutouts (CFTT), engraving and pricing.

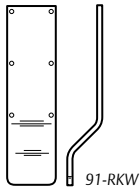
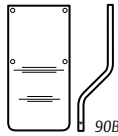
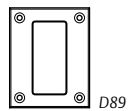

Flush Pulls

Heavy Duty Security - Cast Brass												
Part	4/606	26D/626			10BE/BSP							
D89	218.00	142.00			202.00							

Cylinder Pulls - .125" Thick													
Part	28/628	3/605	4/606	10/612	10B/613	10BE/BSP	26D/626	26/625	32D/630	32/629	32DMS	32D316	32316
90	77.00	86.00	86.00	90.00	90.00	98.00	76.00	96.00	72.00		125.00		
90B	103.00	123.00			129.00	118.00	107.00		94.00		121.00		

Combination Pulls - .125" Thick - See page 12 for standard locations and sizes of Cylinder Cutouts (CFC) and Thumbturn Cutouts (CFTT), engraving and pricing.													
91-RKW	86.00	144.00	144.00	153.00	153.00	116.00	139.00	151.00	79.00		111.00		
92-RKW	134.00			220.00	220.00	174.00	213.00		132.00		156.00		
93-RKW	201.00	371.00	371.00	395.00	395.00	321.00	381.00	381.00	241.00	241.00	280.00		

Flush Pulls													
94		119.00	119.00	119.00	119.00	129.00	117.00	119.00	48.80	122.00	104.00	122.00	168.00
94BTB (pair)		244.00	244.00	244.00	244.00	269.00	236.00	244.00	103.00	250.00	214.00	252.00	342.00
94C		130.00	130.00	130.00	130.00	133.00	126.00	130.00	53.00	126.00	108.00	129.00	173.00
94L		192.00			201.00	153.00	192.00		106.00	140.00	124.00	150.00	198.00
94P		169.00			185.00	133.00	179.00		90.00	126.00	108.00	129.00	173.00
94P x 94L		364.00			389.00	290.00	374.00		199.00	270.00	235.00	282.00	375.00

Dead Lock Pulls - For Barrier Free grip specify BF94DLL or BF94DLS. Used with dead bolt lock. 1 1/4" cylinder hole is standard.													
94DLL		292.00			292.00	299.00	278.00		196.00	242.00	242.00	278.00	329.00
94DLS		243.00			243.00	253.00	235.00		154.00	202.00	202.00	233.00	278.00

Cast Brass - Fasteners concealed in cup.													
95A		37.00	50.00	40.30	41.00	96.00	39.50	50.00					
95B		41.00	53.00	43.60	43.60	101.00	42.20	53.00					
95R		89.00	89.00	93.00	93.00	133.00	91.00	93.00					

Flush Pull - .125" Thick - See page 12 for standard locations and sizes of Cylinder Cutouts (CFC) and Thumbturn Cutouts (CFTT), engraving and pricing.													
96		237.00			254.00	276.00	247.00		147.00		224.00		

Barrier Free													
BF97		309.00	309.00		327.00	307.00	315.00		164.00		250.00		
BF97L		365.00	365.00		386.00	376.00	373.00		230.00		308.00		

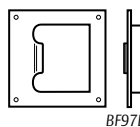
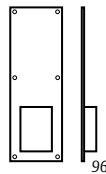
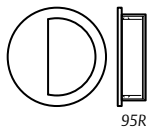
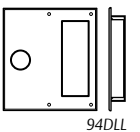
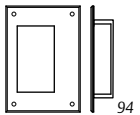

ASSA ABLOY

Experience a safer
and more open world

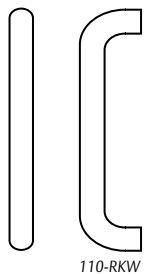

Straight Door Pulls & Door Pull Sets

Straight Door Pulls & Door Pull Sets													
Part	28/628	313/710 315/711	3/605 4/606	10/612	10B/613	10BE/BSP	26D/626	26/625	32D/630	32/629	32DMS	32D316	32316
102-RKW			110.00	137.00	137.00	63.00	103.00	103.00	65.00	100.00	83.00		
105	37.40	46.80	88.00	103.00	103.00	92.00	88.00	90.00	56.00	74.00	92.00	140.00	171.00
106-RKW	37.40	46.80	88.00	106.00	110.00	98.00	90.00	94.00	56.00	76.00	95.00	144.00	175.00
107	40.60	46.80	103.00	120.00	122.00	140.00	103.00	106.00	58.00	83.00	104.00	148.00	178.00
108	42.60	57.00	114.00	135.00	139.00	126.00	118.00	120.00	69.00	95.00	127.00	168.00	198.00
109	71.00	78.00	171.00	218.00	218.00	310.00	162.00	162.00	112.00	139.00	131.00	166.00	201.00
110-RKW	57.00	69.00	173.00	205.00	209.00	190.00	173.00	180.00	108.00	134.00	197.00	264.00	297.00
111A	75.00	83.00	234.00	326.00	326.00	207.00	228.00	228.00	173.00	201.00	193.00	255.00	284.00
111	59.00	71.00	192.00	230.00	237.00	212.00	189.00	196.00	122.00	147.00	221.00	293.00	326.00
112	61.00	75.00	211.00	259.00	263.00	240.00	209.00	218.00	134.00	159.00	235.00	326.00	364.00
118	107.00	119.00	475.00	475.00	475.00	319.00	367.00	367.00	253.00	299.00	292.00	394.00	421.00

See page 34 for mounting selection and charges. NOTE: For BF Barrier Free projection on applicable straight door pulls add: \$9.50 each list. Add \$113.00 for knurling — round pulls only.

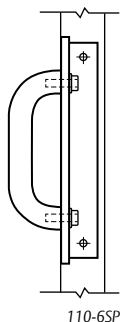

Security Door Pull

Security Door Pull			
Part	10BE/BSP	32D/630	32DMS
110-6SP	556.00	421.00	530.00

For use on security hollow metal doors with reinforcing plate and access hole cover plate with *TORX® - security torx screws — all to be supplied by door manufacturer.

Tubular Door Pulls & Door Pull Sets

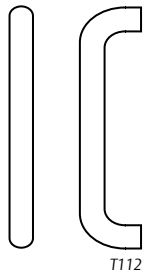

Tubular Straight Door Pulls — Type 1 Thru-Bolt Mount for 1 3/4" Door.						
Part	3/605 4/606	10/612 10B/613	10BE/BSP	32D/630	32/629	32DMS
T110	255.00	260.00	183.00	146.00	179.00	176.00
T111A	267.00	276.00	187.00	150.00	183.00	181.00
T111	267.00	276.00	187.00	150.00	183.00	181.00
T112	280.00	287.00	198.00	156.00	194.00	185.00
T118	315.00	320.00	214.00	179.00	225.00	205.00

*Torx® is a registered trademark of Textron Inc.

ASSA ABLOY

Experience a safer
and more open world

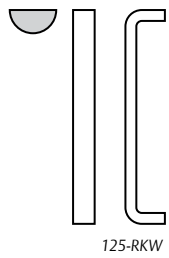

125-RKW

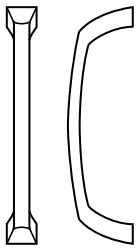

137

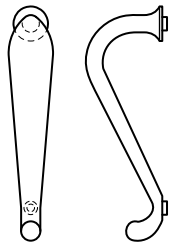

147

Door Pulls

Pulls - Engraving available vertically. See page 12 for pricing.										
Part	28/628	3/605 4/606	10/612	10B/613	10BE/BSP	26D/626	26/625	32D/630	32/629	32DMS
120	212.00	445.00	489.00	489.00	316.00	475.00	475.00	263.00	263.00	288.00
121	224.00	475.00	517.00	517.00	338.00	501.00	501.00	274.00	274.00	303.00
122-RKW	61.00	144.00	192.00	192.00	98.00	182.00	182.00	81.00	81.00	108.00
123	71.00	169.00	213.00	213.00	118.00	207.00	207.00	100.00	100.00	124.00
125-RKW	71.00	153.00	162.00	162.00	133.00	158.00	158.00	108.00	108.00	134.00
126-RKW	75.00	180.00	205.00	205.00	148.00	194.00	194.00	122.00	122.00	145.00
Cast Pulls										
130-RKW	42.40	86.00	86.00	90.00	82.00	78.00	94.00	104.00	143.00	145.00
131-RKW	42.40	86.00	86.00	94.00	82.00	82.00	96.00	104.00	143.00	145.00
132-RKW	63.00	94.00		106.00	120.00	101.00		106.00		131.00
D133-RKW		142.00		247.00	148.00	160.00		118.00	127.00	149.00
134-RKW		139.00		148.00	162.00	144.00				
137		112.00		122.00	135.00	118.00		112.00	112.00	137.00
137L		225.00		225.00	248.00	218.00				
138	92.00	158.00		175.00	193.00	171.00				
139	92.00	158.00		175.00	193.00	171.00				
Cast Pulls - See page 34 for mounting selection and charges.										
147	44.80	180.00	180.00	180.00	199.00	175.00	175.00			
147L		304.00	361.00	361.00	399.00	353.00	353.00			
148		270.00	270.00	270.00	299.00	263.00	263.00			
149		333.00	333.00	333.00	367.00	323.00	323.00			

90° Offset Door Pulls & Door Pull Sets

90° Offset Door Pulls & Door Pull Sets												
Part	28/628	313/710 315/711	3/605 4/606	10/612 10B/613	10BE/BSP	26D/626	26/625	32D/630	32/629	32DMS	32D316	32316
BF150	95.00	119.00	232.00	285.00	190.00	225.00	225.00	159.00	206.00	191.00	248.00	281.00
BF151	106.00	127.00	251.00	141.00	205.00	245.00	245.00	171.00	212.00	197.00	261.00	291.00
BF152	106.00	134.00	232.00	285.00	190.00	225.00	225.00	175.00	206.00	201.00	273.00	311.00
BF156	85.00	99.00	247.00	315.00	282.00	251.00	261.00	149.00	184.00	267.00	399.00	442.00
BF157A	85.00	101.00	266.00	340.00	310.00	270.00	279.00	166.00	203.00	292.00	432.00	470.00
BF157	85.00	101.00	266.00	340.00	310.00	270.00	279.00	166.00	203.00	281.00	415.00	451.00
BF158	92.00	103.00	285.00	365.00	332.00	290.00	299.00	177.00	214.00	316.00	463.00	499.00
BF159	134.00	149.00	367.00	430.00	398.00	373.00	383.00	249.00	302.00	385.00	562.00	596.00
Offset Door Pulls - Type 17 Concealed Mount for 1 3/4" Aluminum Door. (Double Cone Head)												
BF156C17	108.00	122.00	277.00	341.00	310.00	282.00	290.00	177.00	214.00	295.00	244.00	294.00
BF157AC17	111.00	124.00	296.00	369.00	335.00	299.00	310.00	191.00	233.00	319.00	264.00	321.00
BF157C17	111.00	124.00	296.00	369.00	335.00	299.00	310.00	191.00	233.00	319.00	264.00	321.00
BF158C17	113.00	127.00	316.00	395.00	359.00	319.00	329.00	204.00	246.00	342.00	280.00	338.00
BF159C17	159.00	178.00	408.00	478.00	434.00	416.00	428.00	275.00	330.00	415.00	378.00	455.00
Tubular Offset Door Pulls - Type 1 Thru-Bolt Mount for 1 3/4" Door.												
TBF156			295.00	302.00	191.00			152.00	218.00	183.00		
TBF157A			306.00	313.00	200.00			156.00	228.00	188.00		
TBF157			306.00	313.00	200.00			156.00	228.00	188.00		
TBF158			315.00	324.00	204.00			163.00	232.00	192.00		
TBF159			391.00	348.00	266.00			167.00	243.00	185.00		
Tubular Offset Door Pull - Type 17 Concealed Mount for 1 3/4" Aluminum Door. (Double Cone Head)												
TBF156C17			371.00	378.00	251.00			201.00	273.00	230.00		
TBF157AC17			385.00	389.00	256.00			205.00	277.00	235.00		
TBF157C17			385.00	389.00	256.00			205.00	277.00	235.00		
TBF158C17			391.00	396.00	266.00			211.00	281.00	245.00		
TBF159C17			436.00	458.00	308.00			247.00	321.00	285.00		

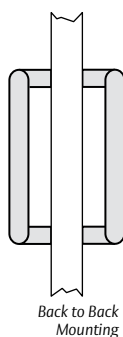
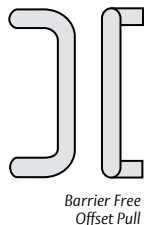

See page 34 for mounting selection and charges. Back to Back Mounting Available: Specify by adding "BTB" to end of part number. For pricing, double the pull price and add \$24.30.

45° Offset Door Pulls

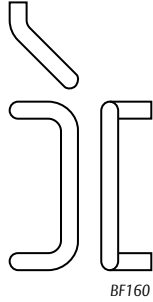

Part	28/628	313/710 315/711	3/605 4/606	10/612 10B/613	10BE/BSP	26/625 26D/626	32D/630	32/629	32DMS	32D316	32316
BF160	95.00	119.00	232.00	285.00	190.00	225.00	159.00	206.00	191.00	248.00	281.00
BF161	106.00	127.00	251.00	308.00	205.00	245.00	171.00	212.00	197.00	261.00	291.00
BF162	95.00	127.00	263.00	308.00	218.00	225.00	175.00	206.00	201.00	248.00	311.00
BF166	113.00	134.00	323.00	391.00	336.00	315.00	281.00	306.00	309.00	368.00	419.00
BF167A	127.00	147.00	340.00	409.00	348.00	331.00	292.00	318.00	320.00	381.00	419.00
BF167	127.00	147.00	340.00	409.00	362.00	331.00	301.00	324.00	330.00	402.00	434.00
BF168	141.00	160.00	361.00	431.00	384.00	353.00	306.00	351.00	353.00	430.00	463.00
BF169	175.00	203.00	439.00	501.00	463.00	427.00	371.00	412.00	426.00	519.00	552.00

See page 34 for mounting selection and charges.

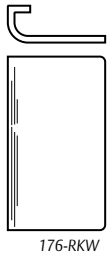

Offset Door Pulls

Part	28/628	313/710 315/711	3/605 4/606	10/612 10B/613	10BE/BSP	32D/630	32DMS
176-RKW	305.00	329.00	868.00	973.00	548.00	457.00	479.00
177	340.00	359.00	973.00	1,071.00	657.00	546.00	567.00
185	368.00	424.00	1,359.00	1,359.00	1,205.00	1,000.00	1,015.00

Call factory for engraving and pricing.

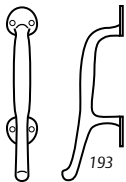

Hospital Door Pull

Part	3/605 4/606	10/612 10B/613	10BE/BSP	26/625 26D/626	32D/630	32DMS
193	137.00	144.00	157.00	139.00	129.00	147.00

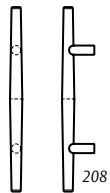

Wooden Door Pull

Part	28/628	313/710 315/711	3/605 4/606	10/612 10B/613	10BE/BSP	26/625 26D/626	32D/630	32/629	32DMS
208	517.00	517.00	492.00	492.00	551.00	475.00	475.00	488.00	502.00

Wood available in Sanded - Unfinished, Oil, or Clear Coated. See page 34 for mounting details. Please see Architectural Price Book page 39 for add on charges.

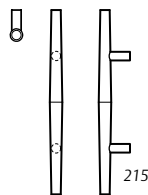

Tapered Door Pull

Part	28/628	313/710 315/711	3/605 4/606	10/612 10B/613	10BE/BSP	26/625 26D/626	32D/630	32/629	32DMS
215	548.00	580.00	916.00	1,025.00	785.00	994.00	624.00	727.00	677.00
215L	729.00	769.00	1,651.00	1,806.00	1,339.00	1,749.00	1,065.00	1,260.00	1,129.00

Larger sizes available upon request. See page 34 for mounting details.

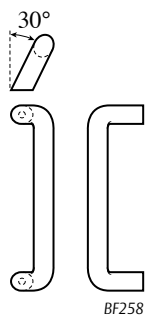

Heavy Duty Offset Pulls

Heavy Duty Offset Pulls											
Part	28/628	313/710 315/711	3/605 4/606	10/612 108/613	10BE/BSP	26/625 26D/626	32D/630	32/629	32DMS	32D316	32316
BF257	331.00	359.00	812.00	933.00	650.00	791.00	541.00	663.00	581.00	707.00	785.00
BF258	359.00	392.00	875.00	992.00	705.00	848.00	587.00	710.00	632.00	752.00	905.00
BF259	370.00	408.00	992.00	1,141.00	778.00	962.00	647.00	769.00	689.00	820.00	905.00
BF260	408.00	436.00	1,141.00	1,323.00	853.00	1,107.00	681.00	834.00	783.00	889.00	969.00

Supplied with 3/8" -16 Thru Bolts.

Vandal Resistant Trim

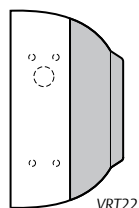

Vandal Resistant Trim			
Part	10BE/BSP	32D/630	32DMS
VRT12	636.00	518.00	590.00
VRT14	638.00	419.00	592.00
VRT16	548.00	370.00	508.00
VRT22		629.00	
VRT24		530.00	
VRT26		475.00	

Specify Exit Device make and model to thru bolt directly to device.

Order form available when ordering.

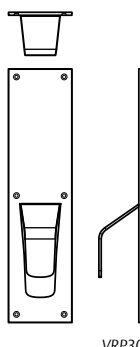

Vandal Resistant Pull

Vandal Resistant Pull		
Part	10BE/BSP	32D/630
VRP30	298.00	274.00

Set up charge for custom powder will apply. Specify Exit Device make and model to thru bolt directly to device (add on price will occur.)

Order form available when ordering.

Pull Plates

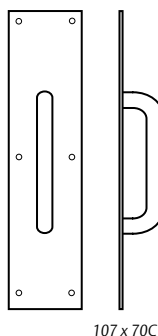

Pull Plates												
Part	28/628	3/605	4/606	10/612	10B/613	10BE/BSP	26D/626	26/625	32D/630	32/629	32DMS	32D316
102 x 70B		118.00	118.00	123.00	123.00	114.00	116.00	121.00	64.00	88.00	94.00	
102 x 70C		128.00	128.00	134.00	134.00	121.00	125.00	128.00	64.00	94.00	94.00	
105 x 70B	63.00	143.00	143.00	157.00	157.00	143.00	143.00	147.00	80.00	103.00	138.00	193.00
105 x 70C	66.00	149.00	149.00	167.00	167.00	151.00	152.00	155.00	80.00	107.00	143.00	198.00
106 x 70B	63.00	145.00	145.00	161.00	165.00	151.00	145.00	149.00	80.00	105.00	140.00	196.00
106 x 70C	66.00	152.00	152.00	170.00	174.00	158.00	155.00	157.00	80.00	110.00	145.00	201.00
107 x 70B	63.00	155.00	155.00	174.00	177.00	160.00	155.00	159.00	82.00	112.00	145.00	198.00
107 x 70C	66.00	161.00	161.00	186.00	186.00	167.00	165.00	170.00	73.00	117.00	149.00	204.00
110 x 70B	81.00	225.00	225.00	261.00	265.00	241.00	225.00	232.00	131.00	164.00	241.00	318.00
110 x 70C	81.00	234.00	234.00	268.00	273.00	247.00	234.00	240.00	134.00	169.00	244.00	324.00
111 x 70B	83.00	245.00	245.00	285.00	290.00	265.00	242.00	249.00	143.00	178.00	262.00	349.00
111 x 70C	86.00	251.00	251.00	293.00	302.00	272.00	249.00	259.00	145.00	182.00	266.00	349.00
122 x 70B	66.00	136.00	136.00	149.00	152.00	136.00	145.00	149.00	99.00	119.00	131.00	148.00
122 x 70C	68.00	147.00	147.00	157.00	159.00	145.00	152.00	157.00	101.00	103.00	131.00	150.00
123 x 70B	71.00	170.00	170.00	172.00	172.00	156.00	172.00	177.00	107.00	112.00	140.00	160.00
123 x 70C	73.00	183.00	183.00	183.00	183.00	162.00	181.00	186.00	110.00	112.00	140.00	162.00
125 x 70B	71.00	152.00	152.00	157.00	157.00	143.00	149.00	159.00	114.00	201.00	229.00	265.00
125 x 70C	73.00	161.00	161.00	165.00	165.00	151.00	157.00	170.00	117.00	119.00	147.00	170.00
126 x 70B	71.00	165.00	165.00	170.00	170.00	153.00	161.00	172.00	134.00	136.00	161.00	186.00
126 x 70C	73.00	174.00	174.00	177.00	177.00	160.00	170.00	181.00	134.00	138.00	164.00	191.00
132 x 70B	59.00	111.00	113.00	116.00	118.00	107.00	111.00	128.00	96.00	99.00	126.00	
132 x 70C	61.00	118.00	121.00	123.00	125.00	114.00	118.00	140.00	96.00	99.00	126.00	
137 x 70B	68.00	131.00	134.00	134.00	136.00	123.00	131.00	136.00	117.00	119.00	147.00	
137 x 70C	73.00	140.00	145.00	143.00	145.00	132.00	143.00	145.00	117.00	123.00	149.00	

Barrier Free - Available in 2 1/2" clearance add \$9.50 list (excludes 132 and 137).

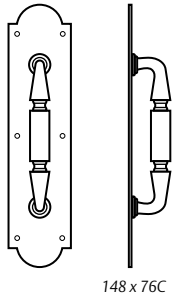

148 x 76C

Decorative Pull Plates

Decorative Pull Plates				
Part	3/605 4/606	10/612 10B/613	10BE/BSP	26/625 26D/626
147 x 76B	302.00	317.00	349.00	304.00
147 x 76C	315.00	324.00	357.00	447.00
147 x 77B	302.00	317.00	349.00	304.00
147 x 77C	315.00	324.00	357.00	447.00
148 x 76B	396.00	408.00	447.00	396.00
148 x 76C	408.00	421.00	463.00	404.00
148 x 77B	396.00	408.00	447.00	396.00
148 x 77C	408.00	421.00	463.00	404.00

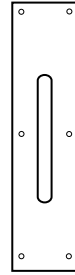

T110 x 70C

Tubular Pull Plates

Tubular Pull Plates						
Part	3/605 4/606	10/612 10B/613	10BE/ BSP	32D/630	32/629	32DMS
T110 x 70B	308.00	333.00	225.00	181.00	230.00	209.00
T110 x 70C	321.00	341.00	229.00	185.00	235.00	213.00
T111 x 70B	328.00	345.00	229.00	185.00	239.00	213.00
T111 x 70C	335.00	354.00	242.00	194.00	244.00	223.00

Corner Guards



290

Corner Guards				
Part	Size	3/605 4/606	10/612 10B/613	32D/630
290	2" x 2" x 40"	192.00	230.00	123.00
	2" x 2" x 48"	204.00	244.00	130.00
	3" x 3" x 40"	219.00	263.00	140.00
	3" x 3" x 48"	239.00	285.00	152.00
291	2" x 2" x 40"	209.00	250.00	133.00
	2" x 2" x 48"	219.00	263.00	140.00
	3" x 3" x 40"	235.00	283.00	151.00
	3" x 3" x 48"	254.00	304.00	163.00

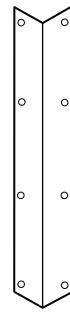

295

Corner Guards						
Part	Size	3/605 4/606	10/612 10B/613	10BE/ BSP	32D/630	32DMS
295	2" x 2" x 40"	154.00	184.00	143.00	99.00	138.00
	2" x 2" x 48"	166.00	198.00	154.00	106.00	150.00
	3" x 3" x 40"	182.00	218.00	171.00	116.00	166.00
	3" x 3" x 48"	199.00	241.00	186.00	128.00	181.00
296	2" x 2" x 40"	177.00	212.00	165.00	113.00	161.00
	2" x 2" x 48"	189.00	226.00	176.00	121.00	172.00
	3" x 3" x 40"	206.00	246.00	191.00	131.00	186.00
	3" x 3" x 48"	223.00	267.00	208.00	142.00	203.00

Other lengths available up to 96" and leg widths up to 6". Part number 290 and 291 includes self-adhesive mounting.

Mortised Door Edges (UL Approved)

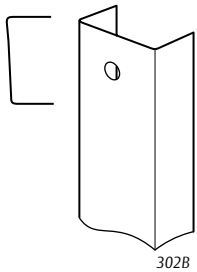

302B

Mortised Door Edges							
Part	Height	3/605 4/606	10/612 10B/613	10BE/BSP	32D/630	32DMS	32D316
300	Up to 42"	224.00	242.00	153.00	120.00	145.00	174.00
	43" - 66"	343.00	372.00	227.00	179.00	214.00	269.00
	67" - 96"	507.00	538.00	314.00	253.00	298.00	378.00
301	Up to 42"	224.00	242.00	153.00	120.00	145.00	174.00
	43" - 66"	343.00	372.00	227.00	179.00	214.00	269.00
	67" - 96"	507.00	538.00	314.00	253.00	298.00	378.00
302	Up to 42"	253.00	270.00	176.00	139.00	167.00	193.00
	43" - 66"	372.00	407.00	261.00	210.00	245.00	301.00
	67" - 96"	553.00	585.00	361.00	298.00	341.00	439.00
302B	Up to 42"	253.00	270.00	176.00	139.00	167.00	193.00
	43" - 66"	372.00	407.00	261.00	210.00	245.00	301.00
	67" - 96"	553.00	585.00	361.00	298.00	341.00	439.00

Available in stainless steel, brass and bronze. UL Listed for fire rated doors. Add \$28.00 per edge - specify UL when ordering (300-UL). Includes Phillips Flat Head Sheet Metal Screw Fasteners. To defray set up costs, add 30% for less than 10 pieces. Add an additional \$25.80 for each cutout.

Order form available when ordering.

Non-Mortise Door Edges (UL Approved)

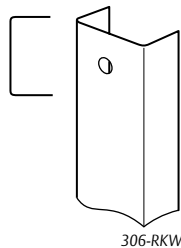

Non-Mortise Door Edges							
Part	Height	3/605 4/606	10/612 10B/613	10BE/BSP	32D/630	32DMS	32D316
304	Up to 42"	224.00	242.00	153.00	120.00	145.00	174.00
	43"- 66"	343.00	372.00	227.00	179.00	214.00	269.00
	67"- 96"	507.00	538.00	314.00	253.00	298.00	388.00
305	Up to 42"	224.00	242.00	153.00	120.00	145.00	174.00
	43"- 66"	343.00	372.00	227.00	179.00	214.00	269.00
	67"- 96"	507.00	538.00	314.00	253.00	298.00	388.00
306-RKW	Up to 42"	253.00	270.00	176.00	139.00	167.00	193.00
	43"- 66"	372.00	407.00	261.00	210.00	245.00	301.00
	67"- 96"	553.00	585.00	361.00	298.00	341.00	439.00
306-AST	Up to 96"	1,450.00	1,450.00	1,380.00	1,307.00	1,307.00	1,424.00
306B	Up to 42"	253.00	270.00	176.00	139.00	167.00	193.00
	43"- 66"	372.00	407.00	261.00	210.00	245.00	301.00
	67"- 96"	553.00	585.00	361.00	298.00	341.00	439.00
306B-AST	Up to 96"	1,450.00	1,450.00	1,380.00	1,307.00	1,307.00	1,424.00
307	Up to 42"	290.00	308.00	212.00	175.00	201.00	233.00
	43"- 66"	440.00	471.00	322.00	267.00	303.00	357.00
	67"- 96"	651.00	678.00	473.00	382.00	447.00	536.00

Available in stainless steel, brass and bronze. UL Listed for fire rated doors. Add \$28 per edge - specify UL when ordering (304-UL). Includes Phillips Flat Head Sheet Metal Screw Fasteners. To defray set up costs, add 30% for less than 10 pieces. Add an additional \$25.80 for each cutout.

Order form available when ordering.

Overlapping Door Edges (UL Approved)

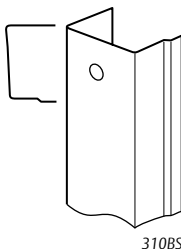

Overlapping Door Edges							
Part	Height	3/605 4/606	10/612 10B/613	10BE/BSP	32D/630	32DMS	32D316
308	Up to 42"	253.00	270.00	176.00	139.00	167.00	193.00
309	Up to 42"	253.00	270.00	176.00	139.00	167.00	193.00
310	Up to 42"	285.00	302.00	176.00	139.00	167.00	193.00
310B	Up to 42"	285.00	302.00	176.00	139.00	167.00	193.00
310BS	Up to 42"	285.00	302.00	176.00	139.00	167.00	193.00

Available in stainless steel, brass and bronze. UL Listed for fire rated doors. Add \$28 per edge - specify UL when ordering (308-UL). Includes Phillips Flat Head Sheet Metal Screw Fasteners. To defray set up costs, add 30% for less than 10 pieces. Add an additional \$25.80 for each cutout.

Order form available when ordering.

Latch Protectors

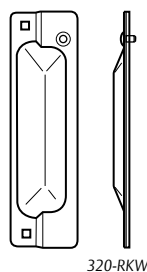

Latch Protectors				
Part	2C/603	10BE/BSP	26D/626	32D/630
320-RKW	30.30	92.00		56.00
320C	30.30	92.00		56.00
320CL	30.30	92.00		56.00
320CXL		92.00		56.00
321	23.30	68.00		41.40
322	21.20	68.00		33.70
325		157.00	97.00	
330		165.00		101.00

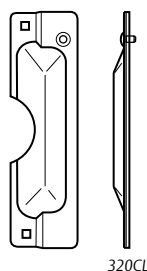

Stops

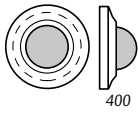

Solid Cast Wall Stops - Rubber Bumper							
Part	3/605	4/606 10/612 10B/613	10BE/BSP	15/619	26D/626	26/625	
400	18.00	23.10	28.70	23.10	15.40	28.80	
401	18.50	23.60	27.10	23.60	16.00	29.30	
402	19.30	24.50	28.20	24.50	16.90	30.50	
403	18.00	23.10	28.70	23.10	15.40	28.80	
404	18.50	23.60	29.30	23.60	16.00	29.30	
405	19.30	24.50	30.40	24.50	16.90	30.50	

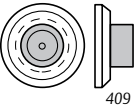

Wrought Wall Stops - Rubber Bumper							
Part	3/605 4/606	10/612	10BE	26D/626	26/625	32D/630	
406	7.80	7.80	9.90	7.80	8.10	5.00	
409	7.80	7.80	9.90	7.80	8.10	5.00	

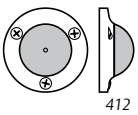

Solid Cast Wall Stops - Rubber Bumper							
Part	3/605	4/606 10/612 10B/613	10BE/BSP	15/619	26D/626	26/625	
412	26.50	28.50	73.00	28.50	24.50	27.50	
415	64.00	62.00	90.00	46.00	42.00	64.00	
416	26.50	28.50	73.00	28.60	24.50	27.50	

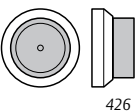

Wrought Wall Stops - Rubber Bumper							
Part	3/605	10BE/BSP	32D/630				
426	8.80	22.30	8.70				

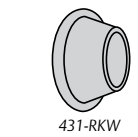

Solid Cast Wall Stop - Rubber Bumper							
Part	3/605 26/625	4/606	10B/613	10BE/BSP	15/619	26D/626	
430-RKW	14.80	16.50	15.90	20.50	23.60	12.30	

Wall Stops - Rubber Bumper			
Part		Gray	White
431-RKW		5.00	
432W			4.60



Dome Stops								
Part	3/605	4/606	10/612	10B/613	10BE/BSP	15/619	26D/626	26/625
440	11.80	12.50	14.50	13.10	18.60	18.00	10.80	12.30
441	13.40	13.10	15.10	13.80	20.40	16.50	12.30	13.10
441CU	20.20	19.30	22.60	20.20	28.60		17.90	19.00
441H	20.80	20.80	22.60	22.60	30.10	24.00	16.80	21.30
442	14.00	14.00	14.80	16.00	21.90	20.00	13.80	14.30
443	15.10	14.80	17.10	16.00	21.20	18.20	13.10	15.40



Cast Riser (for 440 & 441 Dome Stops)								
Part	3/605	4/606	10/612	10B/613	10BE/BSP	15/619	26D/626	26/625
444	6.80	6.80	7.40	7.40	9.90		6.10	6.80

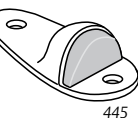

Heavy Duty Door Stop									
Part	3/605	4/606	10/612	10B/613	26D/626	10BE/BSP	15/619	26/625	32D/630
445	44.30	43.30	43.30	43.30	28.50	59.00	46.40	44.60	
445H	66.00	66.00	66.00	74.00	44.00	93.00	74.00	66.00	

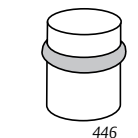

Door Stop									
Part	3/605	4/606	10/612	10B/613	26D/626	10BE/BSP	15/619	26/625	32D/630
446	51.00	51.00	54.00	54.00	37.90	73.00	55.00	52.00	61.00

Riser (for 440 & 442 Dome Stops - 3/4" Riser; 2" Dia. Base)			
Part		Mill	ORB/BRS
449		10.10	10.80

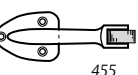

Curved Roller Stop - Rubber Bumper						
Part	3/605	4/606 10/612	10B/613	10BE/BSP	15/619 26/625	26D/626
455	58.00	64.00	67.00	83.00	70.00	55.00

Straight Roller Stop - Rubber Bumper								
Part	3/605	4/606	10/612	10B/613	10BE/BSP	15/619	26D/626	26/625
456-RKW	60.00	64.00	61.00	64.00	89.00	70.00	49.70	60.00
456B Gray (replacement bumper)								10.40
456L	66.00	68.00	68.00	70.00	92.00	87.00	62.00	81.00

Kick Down Door Stop - Rubber Bumper	
Part	BRS, BRZ, CRM
458	16.60

Spring Loaded Plunger Stop - Rubber Bumper								
Part	3/605	4/606	10/612	10B/613	10BE/BSP	15/619	26D/626	26/625
459	70.00	70.00	70.00	76.00	99.00	77.00	56.00	75.00

Kick Down Door Stop - Rubber Bumper								
Part								
460	ALM, BRS, BRZ, ORB							26.80
461	53.00	59.00	59.00	54.00	85.00	70.00	48.50	77.00
461B Gray or Black (replacement bumper)								6.90

Part	3/605	4/606	10/612	10B/613	10BE/BSP	15/619	26D/626	26/625
461L	77.00	74.00	74.00	75.00	97.00	80.00	58.00	82.00

Heavy Duty Door Stops				
Part	2C/603	26D/626	32D/630	Black
462	70.00			
463-RKW			72.00	
464-RKW		148.00		
465		96.00		
466-RKW				45.20
467-RKW				66.00
468-RKW				168.00

Door Stops - Rubber Bumper								
Part	3/605	4/606	10/612	10B/613	10BE/BSP	15/619	26D/626	26/625
470	46.00	56.00	56.00	60.00	74.00	66.00	44.60	65.00
471	46.00	56.00	56.00	60.00	74.00	66.00	44.60	65.00
472	95.00	95.00	95.00	102.00	127.00	108.00	61.00	112.00
473	95.00	95.00	95.00	102.00	127.00	108.00	61.00	112.00
474	58.00	59.00	59.00	60.00	74.00	66.00	43.50	65.00
475	55.00	56.00	56.00	60.00	74.00	63.00	43.80	62.00
476	83.00	83.00	83.00	89.00	111.00	95.00	59.00	104.00
477	83.00	83.00	83.00	89.00	111.00	95.00	59.00	104.00
480	52.00	49.70	49.70	52.00	65.00	66.00	44.00	64.00
480H	61.00	58.00	58.00	60.00	74.00	72.00	49.50	72.00
481	59.00	59.00	59.00	62.00	78.00	68.00	45.70	65.00
481H	62.00	60.00	60.00	63.00	78.00	74.00	51.00	74.00
481MP Powder Coat Finish								157.00
482	44.00	51.00	51.00	46.60	64.00	58.00	41.30	58.00
483	48.40	52.00	52.00	49.70	64.00	64.00	44.60	61.00
485	78.00	70.00	70.00	75.00	93.00	80.00	60.00	80.00

Angle Door Stop - Rubber Bumper	
Part	2C/603
486	18.40

Heavy Duty Wall Stop - Rubber Bumper	
Part	26D/626
487	75.00

ASSA ABLOY

Experience a safer
and more open world

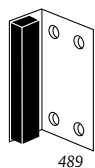

Door Stops (con't)

Door Stops						
Part	3/605	4/606	10/612	10B/613	10BE/BSP	15/619
488	105.00	105.00	116.00	116.00	165.00	112.00
489	128.00	128.00	143.00	143.00	197.00	143.00

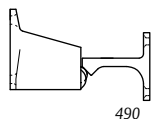

Door Holder & Stop	
Part	26D/626
490	72.00

Automatic Door Holder & Stop								
Part	3/605	4/606	10/612	10B/613	10BE/BSP	15/619	26D/626	26/625
491-RKW	106.00	112.00	112.00	119.00	146.00	141.00	104.00	145.00
491R	109.00	116.00	116.00	121.00	150.00	277.00	106.00	147.00
491S	111.00	118.00	118.00	123.00	153.00		108.00	150.00
494-RKW	130.00	135.00	130.00	135.00	169.00	159.00	121.00	163.00
494R	133.00	138.00	133.00	138.00	171.00		124.00	166.00
494S	135.00	141.00	135.00	141.00	175.00		126.00	168.00



Door Stops - Rubber Bumper								
Part	3/605	4/606	10/612	10B/613	10BE/BSP	15/619	26D/626	26/625
505-RKW	22.80	29.90	29.90	29.90	37.20	32.10	22.20	27.30
508	36.30	36.30	36.30	40.10	49.80	41.00	33.60	36.30



Part	Polished Brass (BRS)				Burnished Aluminum (ALM)			
	3/605	4/606	10/612	10B/613	10BE/BSP	15/619	26D/626	26/625
517				9.10				8.60
518	29.00	29.90	29.90	33.00	40.90	33.00	24.80	29.30
519	24.50	29.90	33.00	31.20	38.80	32.70	23.10	29.00
520 White (replacement bumper)								7.00

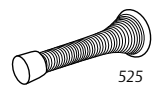
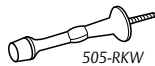

Part	Antique Brass (ANT)			Polished Brass (BRS)		Bright Nickel (NP)	
	3/605	4/606	10/612	10B/613	10BE/BSP	15/619	26D/626
525				2.60	2.60		3.00
526					2.90		3.40
528				8.30	8.30		9.60

Flush Bolts, Guides & Strikes

Flush Bolts, Guides & Strikes								
Part	3/605	4/606	10/612	10B/613	10BE/BSP	15/619	26D/626	26/625
550	49.20	60.00	60.00	64.00	85.00	68.00	49.70	77.00
550G	13.80			13.80	17.20		11.40	
550S	13.80			13.80	17.20		11.40	
554	112.00			112.00	148.00		107.00	
554G	75.00			75.00	99.00		72.00	
554S	75.00			75.00	99.00		72.00	
555	36.60	36.60	39.90	38.10	58.00	46.60	29.50	40.30
555B(1 1/2" standard bolt head)				13.80				
555B(extra long bolt head - specify length)				43.50				
555G	11.60			11.60	14.30		9.20	
555S	11.60			11.60	14.30		9.20	
555ROD/per ft. (specify length)								6.00
555 x 18BFB							297.00	
556WS							84.00	
557	56.00	56.00	56.00	56.00	92.00	75.00	56.00	58.00
557S	13.80			13.80	16.60		11.40	
557 x 19BFB							329.00	
570	41.90	39.00	43.70	43.70	66.00	51.00	33.20	42.20

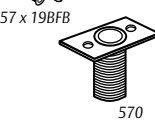
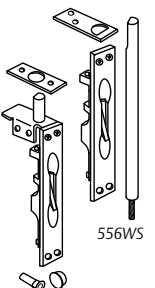
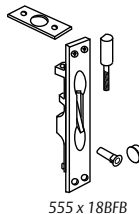

Gravity Door Coordinator

Gravity Door Coordinators					
Part	3/605 4/606	10/612 10B/613	10BE/BSP	15/619 26/625	26D/626
576	133.00	133.00	189.00	148.00	113.00
576B Gray				5.30	

Surface Bolts

Surface Bolts					
Part	3/605	10B/613	10BE/BSP	26D/626	32D/630
580-8	62.00	65.00	132.00	52.00	109.00
580-12			153.00	61.00	
580-18			382.00	63.00	
580-24			411.00	301.00	
582-8					226.00
582-12					276.00

Heavy Duty Surface Bolts

585-12				235.00	
585-24				290.00	

Roller Latches

Roller Latches									
Part	3/605	4/606	10/612	10B/613	10BE/BSP	15/619	26D/626	26/625	
590	63.00	88.00	88.00	68.00	110.00	75.00	52.00	65.00	
590DA (Strike Only)			204.00		204.00		204.00		
590SO	37.30	37.30	37.30	37.30	49.10	44.70	34.80	34.80	
591	68.00	93.00	93.00	81.00	116.00	104.00	57.00	88.00	
591SO	44.70	44.70	42.20	44.70	55.30	52.00	39.70	39.70	
592	63.00	88.00	88.00	66.00	110.00	88.00	52.00	65.00	
592SO	37.30	37.30	37.30	37.30	49.10	42.20	34.80	34.80	
Part	3/605	4/606	10/612	10B/613	10BE/BSP	15/619	26D/626	26/625	
593	131.00	131.00	162.00	148.00	97.00	142.00			
Part	3/605	4/606	10/612	10B/613	10BE/BSP	15/619	26D/626	26/625	
593SO	37.30			37.30	49.10		34.80		
594	81.00	81.00	81.00	89.00	110.00	89.00	55.00	81.00	
594SO					49.10				

Gate Latch

Gate Latch				
Part	4/606	10/612 10B/613	10BE/BSP	26D/626
602	96.00	96.00	125.00	90.00
602 Spring (25 pk)				27.00

Door Guards

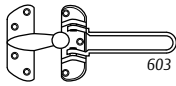

Door Guards				
Part	Antique Brass (ANT)	Polished Brass (BRS)	Bright Chrome (CRM)	
603	24.30	24.30	24.30	
603 Shim	Clear Plastic		6.50	
	3/605	4/606	10/612 10B/613 15/619	26D/626 26/625
604	54.00	51.00	56.00	43.50 51.00
604 Shim	Clear Plastic		6.60	

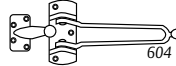

Door Guard Protection Plate

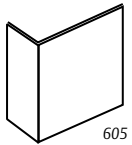

Door Guard Protection Plate				
Part	3/605 4/606	10/612 10B/613 15/619	26D/626	26/625
605	12.40	12.40	13.30	13.90
605SMS	25.40	27.90	25.40	25.40

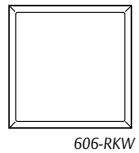

Wall Guard

Wall Guard		
Part	Pack Size	Clear
606-RKW	55/sheet	110.00

606-RKW

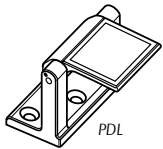

Privacy Door Latch

Privacy Door Latch			
Part	3/605	10B/613	26D/626
PDL	78.00	117.00	75.00

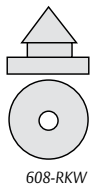

Door Silencers

Door Silencers			
Part	Pack Size	Clear	Gray Rubber
608-RKW	100		19.00
608CA	300	197.00	
609	100		28.00

608-RKW

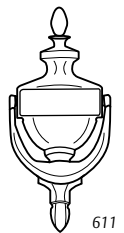

Door Knockers

Door Knockers							
Part	3/605	4/606	10/612	10B/613	10BE/BSP	15/619	26D/626
611	82.00	105.00	105.00	111.00	135.00	117.00	80.00
614	67.00	88.00	72.00	88.00	111.00	112.00	65.00
614V	67.00	88.00	111.00	88.00	109.00	88.00	65.00

For 611, drill for Viewer. Add \$10.00.

Door Viewers

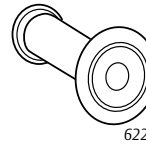

Door Viewers					
Part	Antique Bronze (ANT)	Polished Brass (BRS)	Bright Chrome (CRM)	Satin Nickel (STNN)	Dull Chrome (DCRM)
619	22.80	20.80	20.80	22.20	
620	12.90	12.90	12.90	15.10	
621	15.20	15.20	15.20		
622	19.40	19.40	19.40	22.20	19.60

Door Viewer Washers

Door Viewer Washers				
Part	Antique Bronze (ANT)	Polished Brass (BRS)	Bright Chrome (CRM)	Satin Nickel (STNN)
618W	16.60	16.60	16.60	16.30

* Universal washer to fit all Rockwood Door Viewers.

Door Viewers with Covers

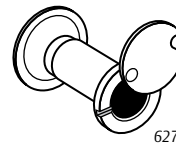

Door Viewers with Covers						
Part	Pack Size	Antique Bronze (ANT)	Polished Brass (BRS)	Bright Chrome (CRM)	Dull Chrome (DCRM)	Black (BLK)
620VC Covers Only	10		90.00	90.00	90.00	
622VC Covers Only	10		111.00	111.00	111.00	
624		20.50	20.50	20.50		
626		26.60	26.60	26.60	26.60	
627				37.50		49.50
628				36.60		48.00
629				39.50		52.00

Surface Bolts

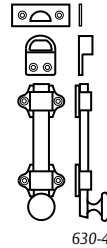

Surface Bolts				
Part	3/605	10B/613	10BE/BSP	26D/626
630-4	54.00	64.00	127.00	52.00
630-8	100.00	120.00	199.00	97.00
630-12	180.00	232.00	337.00	225.00
630-24	305.00	392.00	636.00	379.00

Card Holder

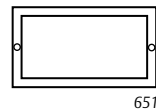

Card Holder				
Part	3/605 4/606	10/612 10B/613	10BE/BSP	26D/626
651	43.30	43.30	53.00	40.70

Decals

Decals	
Part	Price
660	13.60
661	13.60
662-RKW	13.90

THIS DOOR TO REMAIN UNLOCKED DURING BUSINESS HOURS
660

THIS DOOR TO REMAIN UNLOCKED WHILE BUILDING IS OCCUPIED
661

THESE DOORS TO REMAIN UNLOCKED WHILE BUILDING IS OCCUPIED
662-RKW

ASSA ABLOY

Experience a safer
and more open world

670 Series Engraved Signs

•SPECIFY COPY•

670

•WOMEN•

670W

P
U
S
H

674H

670 Series Engraved								
Part	Black or Brown Plastic	28/628	3/605 4/606	10/612	10B/613	10BE/BSP	26/625 26D/626	32D/630
670 (1"H Letters or smaller)	16.17	22.49	23.25	24.03	24.60	53.10	24.03	44.52
670M	41.00	76.00	68.00	76.00	76.00	112.00		81.00
670W	58.00	103.00	107.00	120.00	120.00	156.00		116.00
670R	41.00	150.00	155.00	155.00	155.00	211.00		170.00
674H (PUSH)	48.00	63.00	95.00	85.00	85.00	109.00	85.00	88.00
674L (PULL)	48.00	63.00	95.00	85.00	85.00	109.00	85.00	88.00

Available in .125" thick plastic or .050" thick metal. Pricing for 670 is minimum of 3 letters. Over 3 letters there will be an additional charge per letter; per sign for Part's 670M, 670W, 670R. Over 1"H letters contact factory for pricing. Call for pricing on multi-line signs.

BF680 Series Barrier Free Signs

•SPECIFY COPY•

BF680

BF680 Series Barrier Free									
Part	Black, Blue, Brown or Red Plastic	28/628	3/605 4/606	10/612	10B/613	10BL/614	10BE/BSP	26/625 26D/626	32D/630
BF680	39.00	74.00	72.00	72.00	72.00	79.00	81.00	69.00	88.00
BF680M	73.00	167.00	155.00	155.00	155.00	183.00	218.00	148.00	172.00
BF680W	106.00	243.00	227.00	227.00	227.00	254.00	335.00	217.00	268.00
BF680R	149.00	354.00	329.00	329.00	329.00	359.00	516.00	320.00	417.00

Standard 1" letter height. Grade 2 Braille translations. Available in .125" non-glare plastic or .050" thick metal. Pricing is per letter for Part BF680 priced 3 letter minimum. Over 3 letters there will be additional charger per letter for Part's BF680M, BF680W, BF680R. Screw mounting provided. Self-adhesive mounting available.

BF Series ADA Tactile Signs



BF685



BF687



BF688

BF Series ADA Tactile						
Part	Black, Blue, Brown or Red Plastic	3/605 4/606	10/612 10BL/614	10BE/BSP	26/625 26D/626	32D/630
BF683	127.00	383.00	383.00	417.00	352.00	338.00
BF684	127.00	379.00	379.00	417.00	352.00	338.00
BF685	127.00	379.00	379.00	417.00	352.00	338.00
BF686	127.00	440.00	440.00	488.00	408.00	393.00
BF687	127.00	409.00	409.00	453.00	378.00	364.00
BF688	127.00	409.00	409.00	453.00	378.00	364.00
BF689	127.00	440.00	440.00	488.00	408.00	393.00

Standard 1" letter height. Grade 2 Braille translations. Available in .125" non-glare plastic or .050" thick metal. Screw mounting provided. Self-adhesive mounting available.

BFM Series ADA Molded Plastic Signs



BFM687



BFM688



BFM689

Molded Plastic		
Part	Black	Blue
BFM682	33.80	33.80
BFM684	33.80	33.80
BFM685	33.80	33.80
BFM686	33.80	33.80
BFM687	33.80	33.80
BFM688	33.80	33.80
BFM689	33.80	33.80

Standard 5/8" letter height. Grade 2 Braille translations. Self-adhesive mounting.



BFM624



BFM625

All Gender Restroom Signs

Molded Plastic	
Part	Blue
BFM624	46.30
BFM625*	36.80

*Standard 5/8" letter height. Grade 2 Braille translations. Self-adhesive mounting.

Auxiliary Hardware

Hand Rail Brackets - Specify Wood or Metal Rail

Part	3/605	10B/613	10BE/BSP	15/619	26D/626	26/625
700	122.00	135.00		149.00	131.00	130.00
701	124.00	132.00	169.00	140.00	123.00	124.00
702	110.00	119.00	157.00	130.00	114.00	113.00

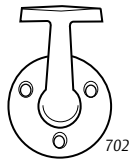

Coat Hooks

Part	3/605	10B/613	10BE/BSP	15/619	15A/620	26D/626	26/625
790	18.70	24.80	46.00		46.60	17.10	20.40
796	19.60	26.80	49.10	27.10	43.30	20.80	17.10
802	22.40	29.10	56.00	27.80	45.60	23.60	19.10
806	24.80	32.00	60.00	32.00	48.00	27.30	22.20

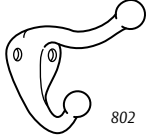
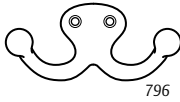

Ball Knob

Part	3/605	10B/613	10BE/BSP	15/619	26D/626	26/625
841	18.00	26.80	38.90	27.30	17.40	18.00

Utility Pull

Part	3/605/4/606	10B/613	10BE/BSP	26/625/26D/626	Burnished Aluminum
845	65.00	71.00	87.00	69.00	25.30

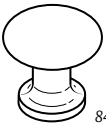

Wire Pulls - Specify Door Thickness

Part	3/605/4/606	10B/613	10BE/BSP	26D/626	26/625	32D/630	32DMS
850	63.00	67.00	66.00	60.00	60.00	56.00	78.00
851	63.00	67.00	66.00	60.00	60.00	56.00	78.00
852	63.00	67.00	66.00	60.00	60.00	56.00	78.00
853	13.80	23.60	49.60	14.60	13.80	14.30	59.00
856-RKW	70.00	72.00	75.00	67.00	67.00	65.00	89.00

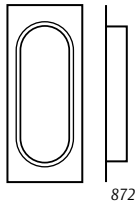

Flush Pulls

Part	3/605	10BE/BSP	26D/626	32D/630
860		26.80		13.10
870	11.40	17.80		8.20
872	28.90	59.00	32.70	

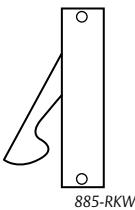

Edge Pulls

Part	3/605	10B/613	10BE/BSP	26D/626	26/625
880	26.10	28.70		25.40	
885-RKW	86.00	98.00	150.00	95.00	98.00

Pocket Door Pulls - For use on 1 3/8" to 1 3/4" Doors

Part	3/605	10B/613	26D/626	26/625
890	26.80	28.70	25.80	26.80
891	27.80	30.30	27.00	27.80

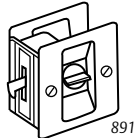

Magnetic Catches

Part	Brass	Aluminum
900	17.30	18.20
901	24.90	26.10

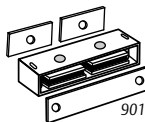

Adjustable Ball Catches

Part	3/605	26D/626
910	18.30	18.10
910RC	26.90	24.20
911	19.30	19.20
911RC	29.50	26.90

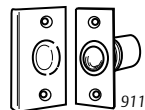

Coordinators

Carry Bar for 2600 Series Coordinators

Part	Black Prime Coated	3/605/4/606	10/612/26D/626	10B/613
1100	100.00	147.00	95.00	147.00

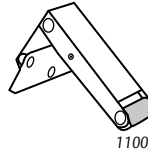

Mounting Brackets (For Soffit Applied Hardware)

Part	Black Prime Coated	28/628
2601AB	37.00	53.00
2601C	37.00	53.00

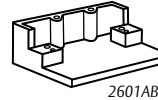

2600 Series Coordinators w/Filler and Filler Bars

NX2648-NX2654	242.00	268.00
2655-2660	251.00	244.00
2661-2672	193.00	244.00
2673-2696	222.00	268.00
L2662-L26112	193.00	244.00
FB-1	73.00	60.00
FB-2	70.00	69.00

1700 Universal Door Coordinator

1700	205.00	218.00
------	--------	--------

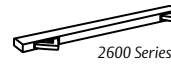

Flush Bolts

Flush Bolts

Part	3/605/4/606/10/612/10B/613/26/625	10BE/BSP	26D/626	32D/630
2805	151.00	224.00	146.00	147.00
2840	151.00	224.00	146.00	147.00
2842	286.00	425.00	256.00	258.00
2845	286.00	425.00	276.00	279.00
2848	286.00	425.00	276.00	279.00
2849	286.00	425.00	276.00	279.00
2905	158.00	218.00	153.00	154.00
2940	158.00	218.00	153.00	154.00
2942	308.00	458.00	276.00	279.00
2945	308.00	458.00	298.00	301.00
2948	308.00	424.00	298.00	301.00
2949	308.00	412.00	298.00	301.00
2960	360.00	497.00	350.00	352.00
2962	360.00	497.00	350.00	352.00
BFB (wood or metal door)				244.00
CPK2840	43.30	55.30	41.10	41.90

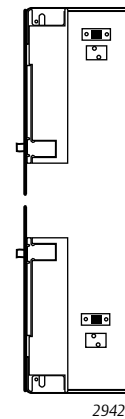
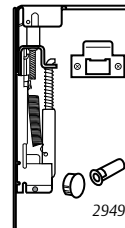

AUXILIARY HARDWARE / COORDINATORS / FLUSH BOLTS

700 - 2962

ASSA ABLOY

Experience a safer and more open world

Overhead Holders & Stops

Heavy Duty Concealed		
Part	10B/613	32D/630
OH101S	665.00	619.00
OH102S	665.00	619.00
OH103S	665.00	619.00
OH104S	665.00	619.00
OH105S	665.00	619.00
OH101H	665.00	563.00
OH102H	665.00	563.00
OH103H	665.00	563.00
OH104H	665.00	563.00
OH105H	665.00	563.00
Standard Duty Concealed		
OH201M	323.00	251.00
OH202M	323.00	251.00
OH203M	323.00	251.00
OH204M	323.00	251.00
OH205M	323.00	251.00
Heavy Duty Surface Mounted		
OH901S	628.00	552.00
OH902S	628.00	552.00
OH903S	628.00	552.00
OH904S	628.00	552.00
OH905S	628.00	552.00
OH901H	628.00	552.00
OH902H	628.00	552.00
OH903H	628.00	552.00
OH904H	628.00	552.00
OH905H	628.00	552.00
Standard Duty Surface Mounted		
OH1001M	401.00	273.00
OH1002M	401.00	273.00
OH1003M	401.00	273.00
OH1004M	401.00	273.00
OH1005M	401.00	273.00

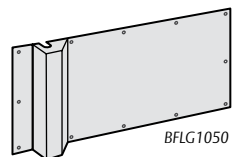
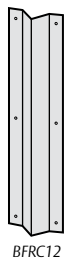
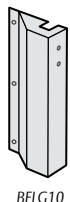
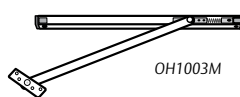
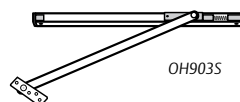
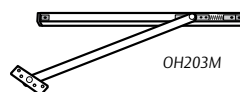
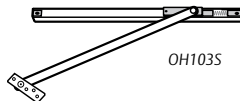

Covers

Latch Guard Covers - .050" Thick (Specify Handing)				
Part	3/605	10B/613	10BE/BSP	32D/630
BFLG10			306.00	246.00
BFLG12			320.00	255.00
BFLG16			353.00	286.00
Vertical Rod Covers - .050" Thick				
BFRC12	137.00	146.00	112.00	93.00
BFRC24	218.00	232.00	160.00	130.00
Vertical Rod Latch Guard Cover				
Part	Width of Door	10BE/BSP	32D/630	
BFLG1050	Up to 36"	519.00	391.00	

Over 36" add \$1.90/in.

Pivots

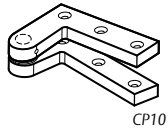

CP10

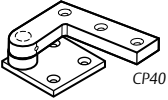

CP40

Standard Head				
Part	3/605 4/606	10/612 10B/613	10BE/BSP	26/625 26D/626
CP10	564.00	617.00	795.00	596.00
CP10HD	818.00	873.00	1,128.00	846.00
Standard Floor				
CP40	564.00	617.00	795.00	596.00
CP40HD	818.00	873.00	1,128.00	846.00

Prices are for 1 3/4" thick wood doors. Pivots for thicker doors are priced on application. Allow 4 weeks delivery. NOTE: Pivots are 3/8" x 7/8" wide; HD (heavy duty) pivots are 1/2" x 1" wide.

Order form available when ordering.

Custom Strikes

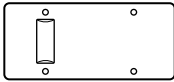

590DA

Custom Strikes					
Part	Quantity	3/605 4/606 10/612 10B/613	10BE/ BSP	26/625 26D/626 32/629	32D/630
CS-ASA1, CS-ASA2, CS-OM, CS-T, 590-DA	Up to 5	113.00	133.00	114.00	85.00
	6 to 10	101.00	119.00	102.00	78.00
	11 to 20	95.00	112.00	95.00	68.00
	21 +	88.00	104.00	89.00	63.00

.090" Thick (\$203 minimum charge. Made to your specifications.)

Order form available when ordering.

Filler Plates & Shims



DF86

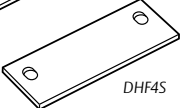

DHF4S

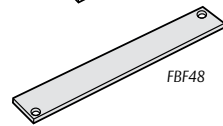

FBF48

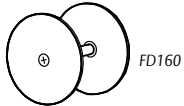

FD160

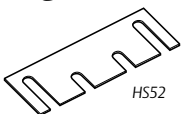

HS52

Filler Plates & Shims			Part	Pack Size	Price
Part	Pack Size	Price	HS54	50	161.00
DF86	25	187.00	LA86	25	333.00
DFF4	25	140.00	LF161	25	125.00
DFF5	25	156.00	SFASA	25	122.00
DHF4B	25	145.00	SF160	25	107.00
DHF4S	25	151.00	SFB160	25	112.00
DHF5B	25	141.00			
DHF5S	25	156.00			
FBF48	25	166.00			
FBS48	25	99.00			
FC161	25	179.00			
FD160	25	156.00			
HS42	50	125.00			
HS44	50	151.00			
HS52	50	151.00			

Sold in pack quantities only.

Angle Plates

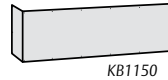

KB1150

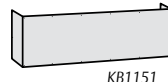

KB1151

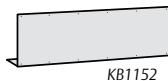

KB1152

Angle Plates		
Part	Description	Pricing
KB1150 Style A	One-Sided	Fax or Email Dimensions for Pricing
KB1151 Style C	Two-Sided	Fax or Email Dimensions for Pricing
KB1152 Style B	Bottom	Fax or Email Dimensions for Pricing

.050" Thick - Refer to page 41 for Angle Plate Fasteners. Add \$75 list per bend to plates price.

Order form available when ordering.

Trim Protector Bars

Heavy Duty - 3/8" thick stainless for heavy traffic.				
Part	CTC	10BE/ BSP	32D/ 630	32DMS
HD2230	8"	382.00	291.00	391.00
HD2240	8"	382.00	291.00	391.00
HD2250	8"	382.00	291.00	391.00

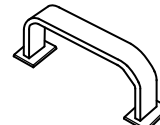

HD2250

Lever - 3/8" thick for heavy traffic.					
Part	3/605	10/612 10B/613	10BE/ BSP	32D/ 630	32DMS
R101LPB	466.00	535.00	266.00	194.00	299.00
R102LPB	533.00	654.00	429.00	363.00	438.00
R111LPB	500.00	599.00	275.00	203.00	281.00
R112LPB	560.00	684.00	492.00	421.00	503.00
R115LPB	535.00	634.00	302.00	214.00	309.00



R111LPB

Exit Device - 3/8" thick stainless for heavy traffic. Field cutting hinge end of exit device is required.			
Part	10BE/ BSP	32D/ 630	32DMS
R116EDPL	677.00	542.00	691.00
R116EDPH	677.00	542.00	691.00

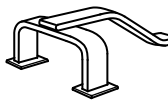

R116EDPH

Standard Duty - 3/16" thick stainless for moderate traffic.			
Part	10BE/ BSP	32D/ 630	32DMS
SD1230	140.00	104.00	144.00
SD1240	140.00	104.00	144.00
SD1250	140.00	104.00	144.00
SD1260	140.00	104.00	144.00

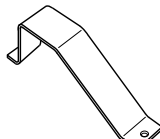

SD1260

ASSA ABLOY

Experience a safer
and more open world

Door Plates Hundred Square Inch Size Chart

To calculate the list price of kick plate, use the hundred square inch number times the list price. (Example: 10" x 34" is 3.40 square inches.) Take that number times the list price from the following page. (Example: 32D list \$19 x 3.40 = \$64.60)

H/W	24"	26"	28"	30"	32"	34"	36"	38"	40"	42"	44"	46"	48"
4"	0.96	1.04	1.12	1.20	1.28	1.36	1.44	1.52	1.60	1.68	1.76	1.84	1.92
6"	1.44	1.56	1.68	1.80	1.92	2.04	2.16	2.28	2.40	2.52	2.64	2.76	2.88
8"	1.92	2.08	2.24	2.40	2.56	2.72	2.88	3.04	3.20	3.36	3.52	3.68	3.84
10"	2.40	2.60	2.80	3.00	3.20	3.40	3.60	3.80	4.00	4.20	4.40	4.60	4.80
12"	2.88	3.12	3.36	3.60	3.84	4.08	4.32	4.56	4.80	5.04	5.28	5.52	5.76
14"	3.36	3.64	3.92	4.20	4.48	4.76	5.04	5.32	5.60	5.88	6.16	6.44	6.72
16"	3.84	4.16	4.48	4.80	5.12	5.44	5.76	6.08	6.40	6.72	7.04	7.36	7.68
18"	4.32	4.68	5.04	5.40	5.76	6.12	6.48	6.84	7.20	7.56	7.92	8.28	8.64
20"	4.80	5.20	5.60	6.00	6.40	6.80	7.20	7.60	8.00	8.40	8.80	9.20	9.60
22"	5.28	5.72	6.16	6.60	7.04	7.48	7.92	8.36	8.80	9.24	9.68	10.12	10.56
24"	5.76	6.24	6.72	7.20	7.68	8.16	8.64	9.12	9.60	10.08	10.56	11.04	11.52
26"	6.24	6.76	7.28	7.80	8.32	8.84	9.36	9.88	10.40	10.92	11.44	11.96	12.48
28"	6.72	7.28	7.84	8.40	8.96	9.52	10.08	10.64	11.20	11.76	12.32	12.88	13.44
30"	7.20	7.80	8.40	9.00	9.60	10.20	10.80	11.40	12.00	12.60	13.20	13.80	14.40
32"	7.68	8.32	8.96	9.60	10.24	10.88	11.52	12.16	12.80	13.44	14.08	14.72	15.36
34"	8.16	8.84	9.52	10.20	10.88	11.56	12.24	12.92	13.60	14.28	14.96	15.64	16.32
36"	8.64	9.36	10.08	10.80	11.52	12.24	12.96	13.68	14.40	15.12	15.84	16.56	17.28
38"	9.12	9.88	10.64	11.40	12.16	12.92	13.68	14.44	15.20	15.96	16.72	17.48	18.24
40"	9.60	10.40	11.20	12.00	12.80	13.60	14.40	15.20	16.00	16.80	17.60	18.40	19.20
42"	10.08	10.92	11.76	12.60	13.44	14.28	15.12	15.96	16.80	17.64	18.48	19.32	20.16
44"	10.56	11.44	12.32	13.20	14.08	14.96	15.84	16.72	17.60	18.48	19.36	20.24	21.12
46"	11.04	11.96	12.88	13.80	14.72	15.64	16.56	17.48	18.40	19.32	20.24	21.16	22.08
48"	11.52	12.48	13.44	14.40	15.36	16.32	17.28	18.24	19.20	20.16	21.12	22.08	23.04

Options

Option	Add	12"H or Less	Over 12" - 48"H
HVBEV	Heavy Beveled Edges	15.10	25.80
BEV	Beveled - No charge included on all plates		
CSK	Countersunk Holes	1.10 per hundred square inch	
SA	Self-Adhesive Mount	39.60	82.00
	CFC	86.00	
	Cut for Louver	267.00	
	Notch for Armor	123.00	
	Add Row of Screws	38.70	
	UL Listing	25.10	

Order form available for K1050 for Notch, Cylinder and Louver preps.

Screw Quantity Chart

Height/Length	17" - 24"	25" - 32"	33" - 40"	41" - 48"
4" - 12"	8 pcs.	10 pcs.	12 pcs.	14 pcs.
13" - 18"	10 pcs.	12 pcs.	14 pcs.	16 pcs.
19" - 24"	12 pcs.	14 pcs.	16 pcs.	18 pcs.
25" - 32"	16 pcs.	18 pcs.	20 pcs.	22 pcs.
33" - 40"	18 pcs.	20 pcs.	22 pcs.	24 pcs.
40" - 48"	20 pcs.	22 pcs.	24 pcs.	26 pcs.

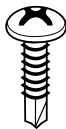

Cut Installation Time in Half with SELF DRILLING TEK SCREWS

- For US32D Kick Plates SP1050; \$41.30/Hundred Pack.
- For US3 Kick Plates SP1069; \$82.40/Hundred Pack
- Packed with each plate - specify when ordering "by TEK Screws".

Size	Screws Required	US32D 630
8" x 34"	12	5.00
10" x 34"	12	5.00
12" x 34"	12	5.00
16" x 34"	14	5.00
36" x 34"	22	9.90

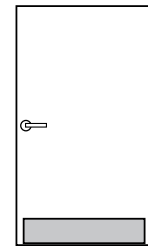

Mop Plate Up to 8"H x 48"W

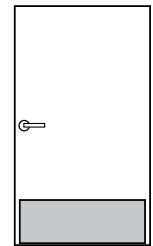

Kick Plate 6" to 12"H x 48"W



TORX SECURITY SCREWS

- For US32D Kick Plates SP1042; \$124.00/Hundred Pack.
- Packed with each plate - specify when ordering "by TORX Screws".

Size	Screws Required	US32D 630
8" x 34"	12	17.40
10" x 34"	12	17.40
12" x 34"	12	17.40
16" x 34"	14	17.40
36" x 34"	22	31.80

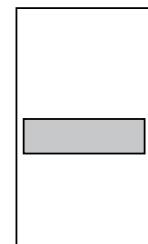

Stretcher Plate 6" to 12"H and up to 48"W

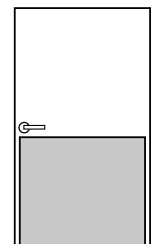

Armor Plate Up to 48"H x 48"W

Price includes bevel edges!

Door Plates

Finish	Maximum Size	8", 10", 12" Height	4", 6" Special Height <12"	12.1" ≤ 36" High	36.1" ≤ 48" High
K1050					
K1050WS (UL+WS add)					
US32DNF (Nickel Free)	48" x 48"	18.30	21.90	18.80	18.80
US32D	48" x 48"	19.60	23.60	20.30	20.30
US32DMS	48" x 48"	32.10	38.50	32.80	32.80
US32D316	40" x 48"	26.40	31.90	27.40	27.40
US32	48" x 48"	44.40	53.60	45.10	45.10
US3	48" x 48"	67.00	80.00	85.00	102.00
US4	48" x 48"	67.00	80.00	85.00	102.00
US9	48" x 48"	75.00	90.00	95.00	116.00
US10	48" x 48"	81.00	96.00	96.00	117.00
US10B	48" x 48"	77.00	93.00	96.00	117.00
10BE	48" x 48"	32.40	38.80	33.00	33.00
US15	24" x 48"	78.00	94.00		
US26D	24" x 48"	77.00	93.00		
US26	24" x 48"	77.00	93.00		
US5	48" x 48"	77.00	93.00	96.00	117.00
US28	48" x 48"	18.80	22.60	19.30	19.30
K1038					
US32D	48" x 48"	19.50	23.30	19.90	19.90
K1062					
32D	48" x 48"	63.90	63.90	63.90	63.90
32DMS	48" x 48"	69.00	69.00	69.00	69.00
10BE	48" x 48"	72.00	72.00	72.00	72.00
K1125					
US32D	48" x 48"	160.00	160.00	160.00	160.00
US3	48" x 48"	315.00	315.00	315.00	315.00
US4	48" x 48"	315.00	315.00	315.00	315.00
US9	48" x 48"	360.00	360.00	360.00	360.00
US10	48" x 48"	338.00	338.00	338.00	338.00
US10B	48" x 48"	338.00	338.00	338.00	338.00
10BE	48" x 48"	185.00	185.00	185.00	185.00
US28	48" x 48"	90.00	90.00	90.00	90.00
ALM DIA	48" x 48"	93.00	93.00	93.00	93.00
K2125					
Stock Plastic	48" x 48"	52.00	52.00	52.00	52.00
K3125					
Stock Plastic	48" x 48"	22.80	22.80	22.80	22.80
K4125					
Clear Plastic	48" x 48"	22.80	22.80	22.80	22.80
K2060					
Stock Kydex .060"	48" x 48"	25.50	29.40	25.50	25.50

OTHER OPTIONS

- Countersunk on .050" Metal Plates add \$1.10 per hundred square inch.
- SA - Self Adhesive Kick Plates 12" high & under add \$39.60 each, over 12" high add \$82.00 each (not available on any US10B size or Brass & Bronze Base Plates over 24" high).

FOR FIRE RATED OPENINGS

- K1050-F* Screw Mounted Plates for steel fire doors rated up to and including 3 hours and wood composite type fire doors rated up to 1 1/2 hours. Available in US32D and all other metal finishes. **Add \$25.10 per plate.** (Maximum Size: 54"H x 46 1/2"W) **UL Approved.**
- K2060SA-F* Self-Adhesive Kydex for 90-minute wood door and 3-hour metal door. **Add \$25.10 per plate.** (Maximum Size: 54"H x 46 1/2"W) **UL Approved.**



* **NFPA 80 STANDARDS — 2-4.5 Protection Plates:** Factory-installed protection plates shall be installed in accordance with the listing of the door. Field-installed protection plates shall be labeled and installed in accordance with their listing. **Exception: Labeling is not required where the top of the protection plate is not more than 16" (406 mm) above the bottom of the door.**

NOTE: Door Plate list pricing is per Hundred Square Inches. Refer to "Hundred Square Inch Size Chart" on page 30 to calculate the list price of each door plate and other available options. See page 41 for special kick plate fasteners.

NOTE: K1050WS plates have a UL and Windstorm rating, add \$50.10 per plate.

ASSA ABLOY

Experience a safer
and more open world



K1050-1 - K1050-8 & K1050A-1 - K1050A-8 (.050" Thick) Shaped Metal Plates Add-On Chart

Add unit price below to list price for kick plate from above chart. Prices are based on same size and same shape.	
Pieces	Pricing
1 - 10 Pieces	Email Dimensions and Quantities for Pricing
11 - 20 Pieces	Email Dimensions and Quantities for Pricing
21+ Pieces	Email Dimensions and Quantities for Pricing

To calculate Shapes™ metal plate price use the largest height x width dimension of the size required to make your design. Refer to "Hundred Square Inch Size Chart" on page 30 and the list price for 32D K1050 kick plates above. Then add the per plate charge supplied by the factory.

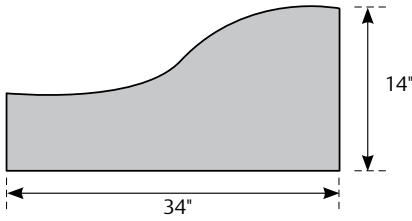

**Example:
 14" x 34" Plate Calculation**

Architectural Finishes

Most of Rockwood's products are available in all of the following architectural finishes. The catalog indicates exceptions. This finish list is grouped by base metal.

Base Metal	Description	Price Book Code	Rockwood Code	BHMA Code
Aluminum	Satin	27	US27	627
Aluminum	Clear Anodized	28	US28	628
Aluminum	Light Bronze Anodized	311	311	—
Aluminum	Medium Bronze Anodized	312	312	—
Aluminum	Dark Bronze Anodized	313	313	710
Aluminum	Extra Dark Bronze Anodized	314	314	—
Aluminum	Black Anodized	315	315	711
Aluminum	White Powder Coat	WPC	WPC	—
Aluminum	Red Powder Coat	RPC	RPC	—
Aluminum	Black Powder Coat	BPC	BPC	—
Brass	Polished Clear Coated	3	US3	605
Brass	Polished No Coating	3NL	US3NL	—
Brass	Satin Clear Coated	4	US4	606
Brass	Satin Oxidized Relieved	5	US5	609
Brass	Satin Nickel Plated Clear Coated	15	US15	619
Brass	Satin Nickel Blackened Relieved Clear Coated	15A	US15A	620
Brass	Flat Black Powder Coated	19	US19	622
Brass	Polished Chrome Plated	26	US26	625
Brass	Satin Chrome Plated	26D	US26D	626
Bronze*	Polished Clear Coated	9	US9	611
Bronze*	Satin Clear Coated	10	US10	612
Bronze*	Satin Black Oxidized Oil Rubbed	10A	US10A	722
Bronze*	Satin Oxidized Oil Rubbed	10B	US10B	613
Bronze*	Satin Oxidized Clear Coated	10BL	US10BL	614
Bronze*	Dark Oxidized Statuary Clear Coated	20A	US20A	624
Stainless Steel	Polished	32	US32	629
Stainless Steel	Satin	32D	US32D	630
Special Finishes (see descriptions)				
Stainless Steel	Satin MicroShield® Coated	32DMS***	US32DMS***	—
Stainless Steel	Polished 316 Alloy	32316***	US32316***	—
Stainless Steel	Satin 316 Alloy	32D316***	US32D316***	—
	Dark Oxidized Satin Bronze, Equivalent	10BE	US10BE	(613E)
	Black Suede Powder Coat	BSP	BSP	—
	White Suede Powder Coat	WSP	WSP	—
	Wrought Black Powder Coat	WB	WB	—

Special Finishes Description

32DMS (MicroShield®): As part of its promise to provide innovative solutions to their customers, ASSA ABLOY Group companies offer the MicroShield® technology, a silver-based antimicrobial coating designed to inhibit the spread of germs and bacteria.

32316 and **32D316** are made from alloy 316 stainless steel containing molybdenum and extra nickel giving it substantially higher corrosion resistance than the standard stainless steels typically used in door hardware. This finish is ideal for use in coastal, urban, and industrial areas that have harsh environmental conditions. **32316** (polish) finishes offer the best corrosion resistance and should be used in caustic environments.

10BE Dark Oxidized Satin Bronze equivalent: This finish provides the richness and warmth of the 10B/613 "living" finish, but maintains its original color and appearance and will not fade or wear over time. The 10BE finish is offered by Corbin Russwin, McKinney, Norton, Rixson, Rockwood, SARGENT and Yale, providing visual consistency between ASSA ABLOY Group brands.

* On most bronze finishes we will supply solid bronze material. Where solid bronze material is not available, we will use brass as a base material with a bronze look powder coat in its place.

*** Available on select items as indicated by the finish icon throughout the catalog.



MicroShield® is a registered trademark of Yale Security Inc., an ASSA ABLOY Group company.

ASSA ABLOY

Experience a safer
and more open world

Set Mounting Charges

Mounting Spec #	Door Type	Pull Type	Mounting Type			Add On
			Pull Free End	Push Free End	Common End	
T1	Metal & Wood	Straight or Offset	12	12	5	65.09
T1HD	Metal & Wood	Straight or Offset	12HD	12HD	5HD	79.51
T2	Glass	Straight or Offset	15	15	13	82.46
T2HD	Glass	Straight or Offset	15HD	15HD	13HD	98.95
T3*	Metal & Wood	Straight or Offset	1	1	5	Included
T3HD	Metal & Wood	Straight or Offset	1HD	1HD	5HD	37.16
T4	Metal	Straight	6	6	5	25.23
T4HD	Metal	Straight	6HD	6HD	5HD	37.62
T4	Metal	Offset	17	17	16	43.52
T4HD	Metal	Offset	17HD	17HD	16HD	46.50
T5	Wood	Straight or Offset	8	8	5	38.94

*T3 is the standard mounting method for Metal and Wood Doors.

NOTE: Heavy Duty (HD) mounting features hex drive for positive tightening and large overall size for superior strength. Recommended for high frequency and rough service openings.

Mounting Types

Pull Style	PULL ON ONE SIDE OF DOOR								PULL ON BOTH SIDES OF DOOR (BTB)				
	Thru Bolt		Deco Thru Bolt	Concealed					Conehead/Set Screw				Lug Plate
Mounting Style	Wood/Metal		Glass	Metal	Metal	Wood	Metal	Metal	Wood/Metal		Glass		Any
Door Type	Wood/Metal		Glass	Metal	Metal	Wood	Metal	Metal	Single	Double	Single	Double	Single
Coneheads	NA	NA	NA	Single	Single	Single	Double	Double	Single	Double	Single	Double	Single
Mounting Type	Type 1	Type 12	Type 15	Type 6	Type 6R	Type 8	Type 17	Type 17R	Type 5	Type 16	Type 13	Type 18	Type 9
Standard (STD) Bolt Size	1/4"-20	1/4"-20	1/4"-20	1/4"-20	1/4"-20	1/4"-20	1/4"-20	1/4"-20	1/4"-20	1/4"-20	1/4"-20	1/4"-20	1/4"-20
Price	INCL	56.68	66.95	16.82	26.57	22.04	25.08	35.43	16.82	25.03	31.02	42.95	55.62
Heavy Duty (HD) Bolt Size	5/16"-18	5/16"-18	5/16"-18	5/16"-18	5/16"-18	5/16"-18	5/16"-18	5/16"-18	5/16"-18	5/16"-18	5/16"-18	5/16"-18	
Price	16.82	66.97	79.32	25.08	37.58	30.82	30.82	44.30	25.08	30.82	39.26	49.13	
Extra Heavy Duty (XHD) Bolt Size	3/8"-16	3/8"-16	3/8"-16										
Price	24.62	73.13	85.54										

Straight Pulls

Pull Type	Dia.	MAXIMUM BOLT SIZE ALLOWED								MAXIMUM BOLT SIZE ALLOWED				
		Type 1	Type 12	Type 15	Type 6	Type 6R	Type 8	Type 17	Type 17R	Type 5	Type 16	Type 13	Type 18	Type 9
Straight	5/8"	STD	STD	STD			STD					STD		
Straight	3/4"	HD	HD	HD	STD		STD			STD		STD		STD
Straight	1"	HD	HD	HD	HD	HD	HD			HD		HD		STD

Offset Pulls

Pull Type	Dia.	MAXIMUM BOLT SIZE ALLOWED								MAXIMUM BOLT SIZE ALLOWED				
		Type 1	Type 12	Type 15	Type 6	Type 6R	Type 8	Type 17	Type 17R	Type 5	Type 16	Type 13	Type 18	Type 9
Offset	5/8"	STD	STD	STD								STD		
Offset	3/4"	HD	HD	HD								STD		
Offset	1"	XHD	XHD	XHD				HD	STD		HD	HD		
Offset	1 1/4"	XHD	XHD	XHD				HD	STD		HD	HD		

NOTE: Heavy Duty (HD) mounting features hex drive for positive tightening and large overall size for superior strength. Recommended for high frequency and rough service openings.

Free End Thru Bolt

TYPE 1 - Thru Bolt Wood or Metal Door

Labels: Pull, Finish Washer, Flat Head Machine Screw, Outside, Inside

Type	Bolt Size	Drill Size	Price
1	1/4"-20	9/32	Incl.
1HD	5/16"-18	11/32	16.82
1XHD	3/8"-16	13/32	24.62

TYPE 12 - Decorative Thru Bolt Wood or Metal Door

Labels: Pull, Thru Bolt

Type	Bolt Size	Drill Size	Price
12	1/4"-20	9/32	56.68
12HD	5/16"-18	11/32	66.97
12XHD	3/8"-16	13/32	73.13

TYPE 15 - Decorative Thru Bolt Glass Door

Labels: Plastic Washers, Pull, Thru Bolt, Neoprene Bushing 5/8" Dia. Hole

Type	Bolt Size	Drill Size	Price
15	1/4"-20	5/8	66.95
15HD	5/16"-18	5/8	79.32
15XHD	3/8"-16	5/8	85.54

Free End Concealed

TYPE 6 - Surface Concealed Metal Door

Minimum diameter of pull is 5/8"

Labels: Cone Head Machine Screw, Pull, Set Screw, Reinforcement by others

For doors with rivnuts specify Type 6R

Type	Bolt Size	Drill Size	Price
6	1/4"-20	1/4"-20 Tap	16.82
*6HD	5/16"-18	5/16"-18 Tap	25.08

TYPE 6R - Surface Concealed Metal Door

Minimum diameter of pull is 1"

Labels: Cone Head Machine Screw, Pull, Set Screw, Rivnut

Type	Bolt Size	Drill Size	Price
6R	1/4"-20	N/A	26.57
*6RHD	5/16"-18	N/A	37.58

TYPE 8 - Surface Concealed Wood Door

Labels: Cone Head Machine Screw, Pull, Set Screw, Knife Thread Insert, 1/4"-20 Set Screw

Type	Bolt Size	Drill Size	Price
8	1/4"-20	23/64-9/16 dp.	22.04
*8HD	5/16"-18	7/16-9/16 dp.	30.82

TYPE 17 - Surface Concealed Metal Door

Minimum diameter of pull is 1"

Labels: Cone Head Machine Screw, Pull, Set Screws, Reinforcement by others

Type	Bolt Size	Drill Size	Price
17	1/4"-20	1/4"-20 Tap	25.08
17HD	5/16"-18	5/16"-18 Tap	30.82

TYPE 17R - Surface Concealed Metal Door

Minimum diameter of pull is 1"

Labels: Cone Head Machine Screw, Pull, Set Screws, Rivnut

Type	Bolt Size	Drill Size	Price
17R	1/4"-20	N/A	35.43
17RHD	5/16"-18	N/A	44.30

*HD mountings feature 2 set screws 180° apart.

NOTE: Y base plates are recommended on wood or glass doors to make a stable and durable mounting (see page 40 for details).
 NOTE: Heavy Duty (HD) mounting features hex drive for positive tightening and large overall size for superior strength.
 Recommended for high frequency and rough service openings.

Flush Pull Mounting

Type 10 Mounting applies to the 94 Series Flush Pulls

TYPE 10 - Surface Mounted Wood or Metal Door

Type	Bolt Size	Drill Size	Price
10	#8-32	9/32	30.82

Wire or Small Post Mount Pull Mounting

NOTE: This mounting should only be used on pulls with mounting points that are 1/2" in diameter.

TYPE 55 - Back-to-Back Wood or Metal Door

Type	Bolt Size	Drill Size	Price
55	#8-32	13/64	30.82

Common End Back-to-Back

TYPE 5 - Back-to-Back Wood or Metal Door
 Minimum diameter of pull is 5/8"

Type	Bolt Size	Drill Size	Price
5	1/4"-20	9/32	16.82
5HD	5/16"-18	11/32	25.08

TYPE 9 - Back-to-Back w/Lug Plate Any Door Type
 Minimum diameter of pull is 5/8"

Type	Bolt Size	Drill Size	Price
9	1/4"-20	N/A	55.62

TYPE 11XHD - Back-to-Back w/Spanner Collar - Wood or Metal Door
 Minimum diameter of pull is 1"

Type	Bolt Size	Drill Size	Price
11XHD	3/8"-16	13/32	63.88

TYPE 13 - Back-to-Back Glass Door

Type	Bolt Size	Drill Size	Price
13	1/4"-20	5/8	31.02
*13HD	5/16"-18	5/8	39.26

TYPE 14XHD - Back-to-Back Glass Door
 Minimum diameter of pull is 1"

Type	Bolt Size	Drill Size	Price
14XHD	3/8"-16	5/8	76.24

TYPE 16 - Back-to-Back Wood or Metal Door
 1" diameter offset pulls only

Type	Bolt Size	Drill Size	Price
16	1/4"-20	9/32	25.03
16HD	5/16"-18	11/32	30.82

TYPE 18 - Back-to-Back Glass Door

Type	Bolt Size	Drill Size	Price
18	1/4"-20	5/8	42.95
18HD	5/16"-18	5/8	49.13

*HD mountings feature 2 set screws 180° apart.

Push and Pull Bar Mounting Details

Sizing of Push Bars

Flush Doors

- Door width: • minus 5" for bent end bars
 • minus 5" for square end post mount bars
 • minus 7" for round end post mount bars

Stile and Rail Doors or Doors with Lites

- Door width: • minus width of one stile

CAUTION: Always confirm bars will not interfere with jamb or cause pinching hazard.

CAUTION: On narrow stile doors, be sure push bar base fits on the stile and bar does not interfere with the stop.

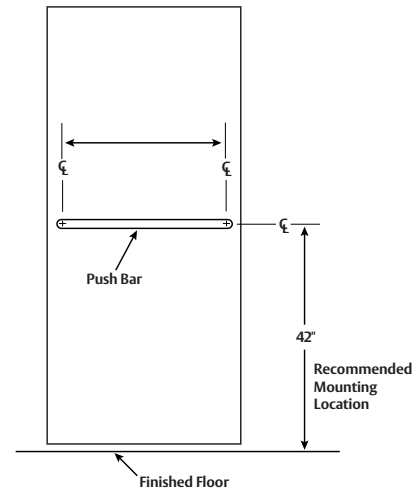

Handing of Doors

The handing of a door is determined from the outside of the opening.

Standing outside the door:

- If the hinges are on the right, it is a right hand door.
- If the hinges are on the left, it is a left hand door.
- If the door opens away from you, it is a regular bevel door.
- If the door opens toward you, it is a reverse bevel door.

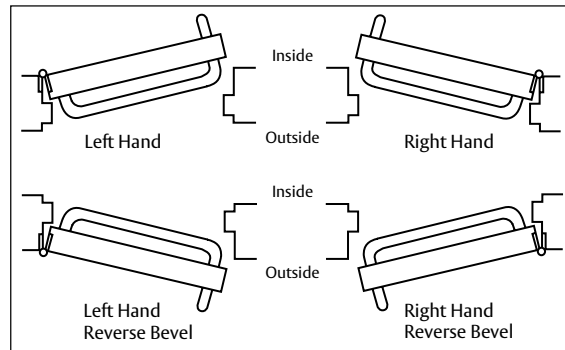

TYPICAL MOUNTING

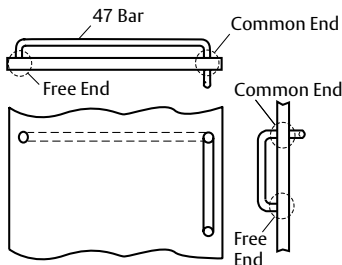

Thru Bolt Mounting - For 1 3/4" Wood and Metal Doors

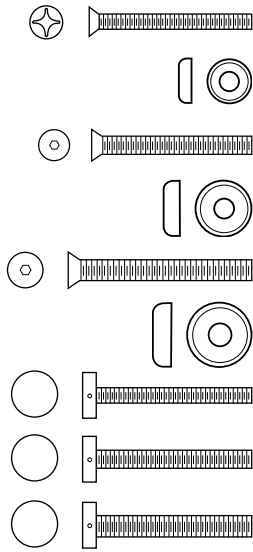

Part	Description	Mounting Type	Price
SP1004	1/4"-20 x 2 1/4" Flat Head Machine Screw Thru Bolt	1	2.50
SP1005	1/4"-20 Finishing Washer	1	1.75
SP1053	5/16"-18 x 2 1/2" Socket Flat Head Machine Screw Thru Bolt	1HD	6.80
SP1054	5/16"-18 Finishing Washer	1HD	2.50
SP1001	3/8"-16 x 2 1/2" Socket Flat Head Machine Screw Thru Bolt	1XHD	10.52
SP1002	3/8"-16 Finishing Washer	1XHD	3.15
SP1003	1" Diameter Decorative Thru Bolt 1/4"-20 x 2 1/4"	12	28.50
SP1055	1" Diameter Decorative Thru Bolt 5/16"-18 x 2 1/4"	12HD	33.90
SP1041	1 1/4" Diameter Decorative Thru Bolt 3/8"-16 x 2 1/4"	12XHD	33.90

Back-to-Back Mounting - For 1 3/4" Wood and Metal Doors

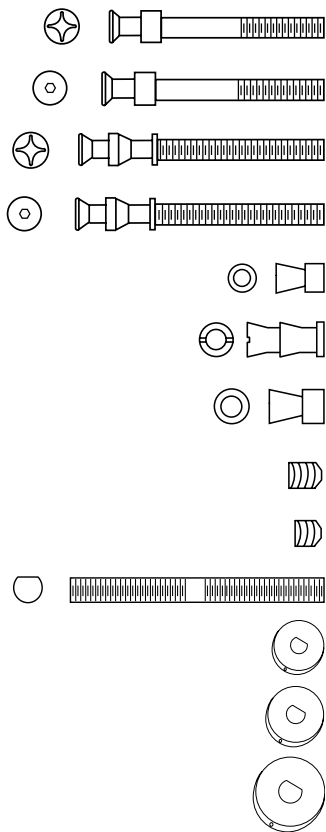

Part	Description	Mounting Type	Price
SP1025	1/4"-20 x 2 1/4" Cone Head Machine Screw	5	7.42
SP1056	5/16"-18 x 2 1/4" Cone Head Machine Screw	5HD	11.70
SP1052	1/4"-20 x 2 1/4" Double Cone Head Machine Screw (for use with offset pulls)	16	8.76
SP1057	5/16"-18 x 2 1/4" Double Cone Head Machine Screw (for use with offset pulls)	16HD	14.40
SP1027	1/4"-20 Cone Head Union (Used to Convert Cone Head to Thru Bolt Hole)	N/A	7.42
SP1079	1/4"-20 Double Cone Head Union (Used to Convert Double Cone Head to Thru Bolt Hole)	N/A	13.04
SP1068	5/16"-18 Cone Head Union (Used to Convert Cone Head to Thru Bolt Hole)	N/A	11.70
SP1026	1/4"-20 x 5/16" Set Screws (Standard)	N/A	1.75
SP1065	1/4"-20 x 3/16" Set Screw (Short)	N/A	2.28
SP1032	3/8"-16 x 3 1/2" LH/RH Bolt	11	15.46
SP1071	Spanner Collar 1" Diameter for LH/RH Bolt	11	23.34
SP1033	Spanner Collar 1 1/4" Diameter for LH/RH Bolt	11	23.34
SP1072	Spanner Collar 1 1/2" Diameter for LH/RH Bolt	11	25.98

ASSA ABLOYExperience a safer
and more open world

USA & Canada Prices Effective March 16, 2020

Copyright © 2020, ASSA ABLOY Accessories and Door Controls Group, Inc. All rights reserved. Reproduction in whole or in part without the express written permission of ASSA ABLOY Accessories and Door Controls Group, Inc. is prohibited.

Concealed Mounting - For 1 3/4" Wood and Metal Doors

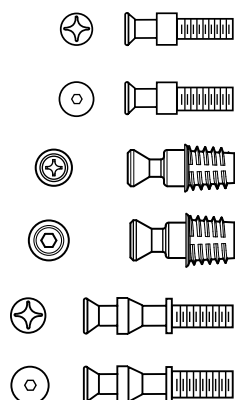

Part	Description	Mounting Type	Price
SP1039	1/4"-20 x 1/2" Cone Head Machine Screw	6 / 6R	7.42
SP1058	5/16"-18 x 1/2" Cone Head Machine Screw	6HD	11.70
SP1080	1/4"-20 Cone Head / Knife Thread Insert	8	12.30
SP1082	5/16"-18 Cone Head / Knife Thread Insert	8HD	12.30
SP1051	1/4"-20 x 1/2" Double Cone Head Machine Screw	17 / 17R	11.70
SP1059	5/16"-18 x 1/2" Double Cone Head Machine Screw	17HD	14.40

Bushings & Washers - For 1/2" Glass Doors

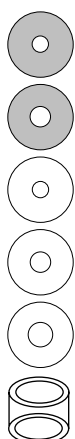

Part	Description	Mounting Type	Price
SP1022	Stainless Steel Washer for 1/4"-20 Cone Head Machine Screw .032" Thick	13	3.16
SP1060	Stainless Steel Washer for 5/16"-18 Cone Head Machine Screw .060" Thick	13HD	3.16
SP1023	Plastic Washer for 1/4"-20 Bolt; Specify Size	13	2.72
SP1061	Plastic Washer for 5/16"-18 Bolt; Specify Size	13HD	2.90
SP1062	Plastic Washer for 3/8"-16 Bolt; Specify Size	14	2.90
SP1024	Glass Door Bushing for 5/8" Hole in Glass; Specify Size	13 / 13HD / 14	3.16

Thru Bolt Mounting - For 1/2" Glass Doors

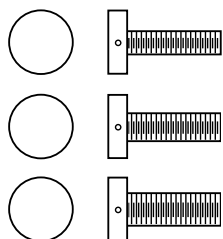

Part	Description	Mounting Type	Price
SP1020	1" Diameter Decorative Thru Bolt; 1/4"-20 x 1 1/8"	15	28.50
SP1063	1" Diameter Decorative Thru Bolt; 5/16"-18 x 1 1/8"	15HD	33.90
SP1040	1 1/4" Diameter Decorative Thru Bolt; 3/8"-16 x 1 1/8"	15XHD	33.90

Back-to-Back Mounting - For 1/2" Glass Doors

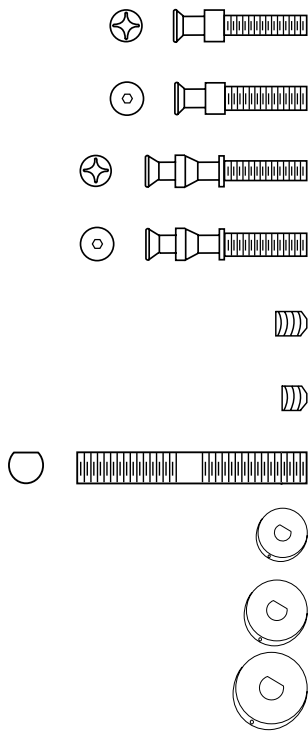

Part	Description	Mounting Type	Price
SP1021	1/4"-20 x 1 1/8" Cone Head Machine Screw	13	7.42
SP1064	5/16"-18 x 1 1/8" Cone Head Machine Screw	13HD	11.70
SP1067	1/4"-20 x 1 1/8" Double Cone Head Machine Screw	18	11.70
SP1066	5/16"-18 x 1 1/8" Double Cone Head Machine Screw	18HD	14.40
SP1026	1/4"-20 x 5/16" Set Screw (Standard)	N/A	1.75
SP1065	1/4"-20 x 3/16" Set Screw (Short)	N/A	2.28
SP1031	3/8"-16 x 1 3/4" LH/RH Bolt (If SP1031 is ordered and KIT14 is not called out fastener will be 2 1/4")	14	15.46
SP1071	Spanner Collar 1" Diameter for LH/RH Bolt	14	23.34
SP1033	Spanner Collar 1 1/4" Diameter for LH/RH Bolt	14	23.34
SP1072	Spanner Collar 1 1/2" Diameter for LH/RH Bolt	14	25.98

Y Base Plates

Specify bolt hole size and finish. Standard pulls require two plates.

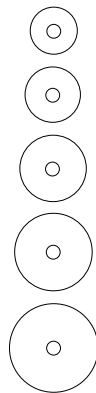

Part	Description	For Use With	Price
SP1073	1/8" Thick x 1 1/16" Diameter	3/4" Diameter Pulls	28.50
SP1074	1/8" Thick x 1 1/4" Diameter	1" Diameter Pulls and Posts	28.50
SP1075	1/8" Thick x 1 1/2" Diameter	1" Diameter Pulls and Posts	28.50
SP1076	1/8" Thick x 1 3/4" Diameter	1" Diameter Pulls and Posts	28.50
SP1077	1/8" Thick x 2" Diameter	1" Diameter Pulls and Posts	28.50

Flush Pull Fasteners

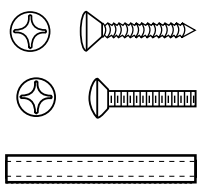

Part	Description	Door Type	Price
SP1006	#8 x 3/4" Oval Head Sheet Metal Screw	Wood or Metal	1.38
SP1007	#8-32 x 3/4" Oval Head Machine Screw	Metal	1.38
SP1034	#8-32 x 1 5/8" Brass Sleeve Machine Screw	Wood or Metal	7.83

Plate Fasteners

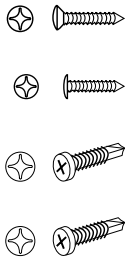

Part	Description	For Use With	Price
SP1008	#6 x 5/8" Oval Head Sheet Metal Screw	Push and Pull Plates; Kick Plates	36.00/c
SP1009	#6 x 3/4" Truss Head Sheet Metal Screw	Plastic / Laminate Kick Plates	36.00/c
SP1050	#6 x 5/8" Pan Head (TEK) Self-Drilling Screw - Stainless Steel	Stainless Steel Kick Plates	90.50/c
SP1069	#6 x 5/8" Pan Head (TEK) Self-Drilling Screw - Brass Plated	Brass Kick Plates	166.40/c

Sex Nuts

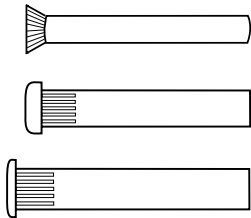

Part	Description	For Use With	Price
SP1018	#8-32 Flat Head Sex Nut	94 Series Flush Pulls	10.50
SP1019	#10-24 x 1 9/16" Sex Nut	580 Surface Bolts	6.10
SP1070	1/4"-20 x 1 9/16" Sex Nut	585 Surface Bolts	14.30

Tamperproof Torx® Head Security Fasteners

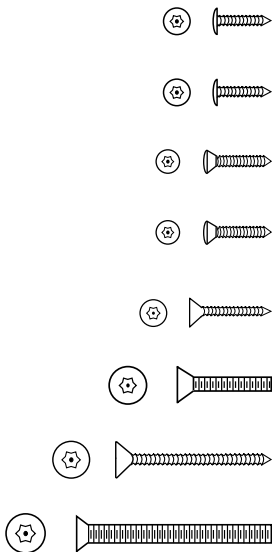

Part	Description	For Use With	Price
SP1016	#6 x 1/2" Button Head Sheet Metal Screw	Plastic Plates	1.80
SP1016B	#6 x 1/2" Button Head Sheet Metal Screw Brass Plated	Kick Plates	5.00
SP1042	#6 x 5/8" Oval Head Sheet Metal Screw	Kick Plates and Push/Pull Plates (Stainless Steel)	1.80
SP1042B	#6 x 5/8" Oval Head Sheet Metal Screw Brass Plated	Kick Plates and Push/Pull Plates	6.50
SP1017	#8 x 3/4" Flat Head Sheet Metal Screw	94 Flush Pulls, 131 Door Pulls, and 555 Flush Bolts	4.20
SP1035	#8-32 x 3/4" Flat Head Machine Screw	94 Flush Pulls, 131 Door Pulls, and 555 Flush Bolts	4.50
SP1037	#12 x 1 1/2" Flat Head Wood Screw	440/442 Door Stops	5.00
SP1038	1/4"-20 x 2 1/2" Flat Head Machine Screw	Door Pulls Type 1 Mount	7.80

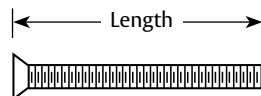

Standard Thru Bolt for Countersunk Holes

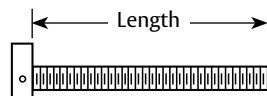

Decorative Thru Bolt for Wood or Metal Doors

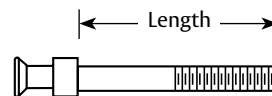

Cone Head Bolt for Back-to-Back Wood or Metal Doors

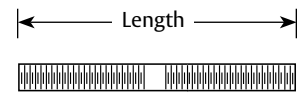

LH/RH Bolt without Heads

Mounting Kits for Door Pulls

Part	Mounting Type	Description	Price
KIT1	1	2 ea. 1/4"-20 x 2 1/4" Thru Bolts and 2 ea. Finish Washers; Specify Finish	8.42
KIT1HD	1HD	2 ea. 5/16"-18 x 2 1/2" Thru Bolts and 2 ea. Finish Washers; Specify Finish	16.80
KIT1XHD	1XHD	2 ea. 3/8"-16 x 2 1/2" Thru Bolts and 2 ea. Finish Washers; Specify Finish	24.62
KIT5	5	2 ea. 1/4"-20 x 2 1/4" Cone Head Bolts and 4 ea. Set Screws	16.82
KIT5HD	5HD	2 ea. 5/16"-18 x 2 1/4" Cone Head Bolts and 4 ea. Set Screws	25.08
KIT6	6	2 ea. 1/4"-20 x 1 1/2" Cone Head Bolts and 4 ea. Set Screws	16.82
KIT6HD	6HD	2 ea. 5/16"-18 x 1 1/2" Cone Head Bolts and 4 ea. Set Screws	25.08
KIT11	11	2 ea. 3/8"-16 x 3 1/2" LH/RH Bolt and 2 ea. Spanner Collars for 1 3/4" Doors; Specify Pull Diameter and Finish	63.88
KIT12-1	12	2 ea. 1/4"-20 x 2 1/4" Decorative Thru Bolts; 1" Dia.; Specify Finish	56.68
KIT12-1HD	12HD	2 ea. 5/16"-18 x 2 1/4" Decorative Thru Bolts; 1" Dia.; Specify Finish	66.97
KIT12-1.25XHD	12XHD	2 ea. 3/8"-16 x 2 1/4" Decorative Thru Bolts; 1 1/4" Dia.; Specify Finish	73.13
KIT12-1.5XHD	12XHD	2 ea. 3/8"-16 x 2 1/4" Decorative Thru Bolts; 1 1/2" Dia.; Specify Finish	31.95
KIT13	13	2 ea. 1/4"-20 x 1 1/8" Cone Head Bolts; 2 ea. Metal Washers; 4 ea. Plastic Washers; 2 ea. Bushings for 1/2" Glass Doors; 4 ea. Set Screws; Specify if other than 1/2" Glass	31.02
KIT13HD	13HD	2 ea. 5/16"-18 x 1 1/8" Cone Head Bolts; 2 ea. Metal Washers; 4 ea. Plastic Washers; 2 ea. Bushings for 1/2" Glass Doors; 4 ea. Set Screws; Specify if other than 1/2" Glass	39.26
KIT14	14	2 ea. 3/8"-16 x 2 1/4" LH/RH Bolt; 2 ea. Spanner Collars; 2 ea. Bushings; 4 ea. Washers for 1/2" Glass Doors; Specify Pull Diameter and Finish	76.24
KIT15	15	2 ea. 1/4"-20 x 1 1/8" Decorative Thru Bolts; 1" Dia.; 2 ea. Bushings; 4 ea. Plastic Washers; Specify Finish and Glass Thickness/Hole Size	66.95
KIT15HD	15HD	2 ea. 5/16"-18 x 1 1/8" Decorative Thru Bolts; 1" Dia.; 2 ea. Bushings; 4 ea. Plastic Washers; Specify Finish and Glass Thickness/Hole Size	79.32
KIT15-1.25XHD	15XHD	2 ea. 3/8"-16 x 1 1/8" Decorative Thru Bolts; 1 1/4" Dia.; 2 ea. Bushings; 4 ea. Plastic Washers; Specify Finish and Glass Thickness/Hole Size	85.54
KIT15-1.5XHD	15XHD	2 ea. 3/8"-16 x 1 1/8" Decorative Thru Bolts; 1 1/2" Dia.; 2 ea. Bushings; 4 ea. Plastic Washers; Specify Finish and Glass Thickness/Hole Size	97.9
KIT16	16	2 ea. 1/4"-20 x 2 1/4" Double Cone Head Bolts and 4 ea. Set Screws	25.08
KIT16HD	16HD	2 ea. 5/16"-18 x 2 1/4" Double Cone Head Bolts and 4 ea. Set Screws	31.02

Part	Mounting Type	Description	Price
KIT17	17	2 ea. 1/4"-20 x 1 1/2" Double Cone Head Bolts and 4 ea. Set Screws	25.08
KIT17HD	17HD	2 ea. 5/16"-18 x 1 1/2" Double Cone Head Bolts and 4 ea. Set Screws	31.02
KIT18	18	2 ea. 1/4"-20 x 1 1/8" Double Cone Head Bolts; 2 ea. Metal Washers; 4 ea. Plastic Washers; 2 ea. Bushings for 1/2" Glass Doors; Specify if other than 1/2" Glass and 4 ea. Set Screws	42.95
KIT18HD	18HD	2 ea. 5/16"-18 x 1 1/8" Double Cone Head Bolts; 2 ea. Metal Washers; 4 ea. Plastic Washers; 2 ea. Bushings for 1/2" Glass Doors; Specify if other than 1/2" Glass and 4 ea. Set Screws	49.14
KIT-T1	T1	1 ea. 1/4"-20 x 2 1/4" Cone Head Bolt; 1 ea. 1/4"-20 Cone Head Union; 2 ea. Set Screws; 2 ea. 1/4"-20 x 2 1/4" — 1" Dia. Decorative Thru Bolts; Specify Finish	73.14
KIT-T2	T2	1 ea. 1/4"-20 x 1 1/8" Cone Head Bolt; 1 ea. 1/4"-20 Cone Head Union; 2 ea. Set Screws; 2 ea. 1/4"-20 x 1 1/8" — 1" Dia. Decorative Thru Bolts; 1 ea. Metal Washer; 6 ea. Plastic Washers; 3 ea. Bushings; Specify Finish	91.70
KIT-T3	T3	1 ea. 1/4"-20 x 2 1/4" Cone Head Bolt; 1 ea. 1/4"-20 Cone Head Union; 2 ea. Set Screws; 2 ea. 1/4"-20 x 2 1/4" Thru Bolts; 2 ea. Finish Washers; Specify Finish	25.04
KIT-T4	T4	1 ea. 1/4"-20 x 2 1/4" Cone Head Bolt; 2 ea. 1/4"-20 x 1 1/2" Cone Head Bolts; 3 ea. Set Screws	25.04
KIT-T5	T5	1 ea. 1/4"-20 x 2 1/4" Cone Head Bolt; 2 ea. 1/4"-20 x 1 1/2" Cone Head Wood Screws; 3 ea. Set Screws	25.04
KITRM1.25	11x1XHD	2 ea. 3/8"-16 x 2 1/2" Thru-Bolts; 2 ea. Finish Washers; 1 ea. 3/8"-16 x 3 1/2" LH/RH Bolt; 1 ea. 1 1/4" Spanner Collar; Specify Finish	56.70
KITRM360	11x 12XHD	2 ea. 3/8"-16 x 2 1/4" Decorative Thru Bolts 1 1/4" Dia.; 1 ea. 3/8"-16 x 3 1/2" LH/RH Bolt; 1 ea. 1 1/4" Spanner Collar; Specify Finish	105.06
KITRM360G	14x 15XHD	2 ea. 3/8"-16 x 2 1/4" Decorative Thru Bolts 1 1/4" Dia.; 1 ea. 3/8"-16 x 2 1/4" LH/RH Bolt; 1 ea. 1 1/4" Spanner Collar; 3 ea. Bushings; 6 ea. Plastic Washers; Specify Finish	123.64
KITRM1.5	11x1XHD	2 ea. 3/8"-16 x 2 1/2" Thru Bolts; 2 ea. Finish Washers; 1 ea. 3/8"-16 x 3 1/2" LH/RH Bolt; 1 ea. 1 1/2" Spanner Collar; Specify Finish	62.86
KITRM380	11x 12XHD	2 ea. 3/8"-16 x 2 1/4" Decorative Thru Bolts 1 1/2" Dia.; 1 ea. 3/8"-16 x 3 1/2" LH/RH Bolt; 1 ea. 1 1/2" Spanner Collar; Specify Finish	123.64
KITRM380G	14x 15XHD	2 ea. 3/8"-16 x 2 1/4" Decorative Thru Bolts 1 1/2" Dia.; 1 ea. 3/8"-16 x 1 1/4" LH/RH Bolt; 1 ea. 1 1/2" Spanner Collar; 3 ea. Bushings; 6 ea. Plastic Washers; Specify Finish	142.18

ASSA ABLOY

Experience a safer and more open world

Notes

The ASSA ABLOY Group is the global leader in access solutions. Every day we help people feel safe, secure and experience a more open world.

ASSA ABLOY



ASSA ABLOY Opening Solutions
Architectural Accessories Group
Rockwood, PA
Phone: (800) 458-2424 • Fax: (800) 922-9212
www.assaabloydooraccessories.us

(In Canada)
Door Security Solutions Canada
160 Four Valley Drive
Vaughan, ON L4K 4T9
P: 800-461-3007
www.assaabloydss.ca