

Olympus Lock, Inc.
PRICE LIST

July 1, 2008



*Commercial-grade cabinet locks, handles and padlocks
for institutional applications.*

18424 Highway 99 · Lynnwood, WA 98037
(206) 362-3290 · (800) 525-0954 · Fax (206) 362-3569
www.olympus-lock.com · info@olympus-lock.com

OLYMPUS 
LOCK, INC.
The cabinet lock innovators.



The cabinet lock innovators.

Olympus® Lock, Inc. designs and manufactures easily rekeyable, pin tumbler cabinet locks and interchangeable core cabinet lock bodies for a broad range of commercial applications. Our mission is to create pin tumbler cabinet locks and accessories of unparalleled innovation, quality, keyway compatibility, and value in a manner which sets a new industry standard for excellence.

Key advantages of Olympus Lock products include:



➤ Easy Rekeyability · Our patented rekeyability features have created a new level of expectation for the cabinet lock industry. Rekeyability saves the end user time and money when servicing is required.

➤ Keyway Compatibility · Olympus® manufactures the broadest assortment of pin tumbler keyways offered by any commercial cabinet lock company including:

- Cabinet locks with National, CCL and Schlage® keyways
- Lock bodies to accept Sargent® original cylinders
- Small format IC core lock bodies that accept Arrow™, Best®, Falcon™, KSP or equivalent SFIC cores
- IC core lock bodies that accept Corbin/Russwin IC cores
- IC core lock bodies that accept large format IC Schlage®, Medeco® Keymark, and Mul-T-Lock IC cores
- IC core lock bodies that accept Medeco/Yale IC cores

We are your single source for pin tumbler cabinet locks!

➤ Innovation · We are a customer driven organization with an emphasis on creating innovative products that meet the ever-changing needs of our customers both today and into the future. Our many U.S. patents and Canadian patents prove our commitment to provide innovative solutions for your cabinet lock needs.

➤ Reliability/Quality/Service · It has always been the intent of Olympus® to provide cabinet locks that are easy to install, use, and service. Each product is carefully designed and engineered at our Lynnwood, Washington headquarters and is manufactured to exacting specifications for function, fit and finish.

➤ Value · Olympus® offers the best value in cabinet locks. In addition to our patented cabinet locks, we also offer a wide range of accessories to make the installation, use, and service of our products as easy as possible. Our key advantages matched with our modest pricing means you get the best product for the money.



TABLE OF CONTENTS

Replacement Guide	Page 4
Handing Chart	Page 4

Terms, Conditions & Warranty	Page
Conditions of Sales	31
Cancellation Policy	31
Delivery	31
Freight Policy	31
Minimum Order Amount	31
Returned Goods Policy	31
Limited Warranty	31

National Keyway	Page
100DR	5
200DW	5
300SD	5
329R	5
998	7
999	7
DCN1,2,3,4	6
N078	6
T37	7

CCL Keyway	Page
500DR	8
600DW	8
400SD	8
429R	8
996	9
997	9
DCR1,2,3,4	9
R078	8

Padlockable Cam Lock	Page
DCP	14

Schlage "C" Keyway	Page
700S	10
800S	10
820S	11
850S	11
L7080	11

Schlage Style - Less Cylinder	Page
700LC	12
800LC	12
820LC	12
850LC	12
L7080LC	13

Sargent Cabinet Lock Bodies	Page
754LC	13
854LC	13

Schlage Large Format I.C. Core	Page
777ICP	15
888ICP	15
920	15

Medeco/Yale I.C. Core	Page
931DR	14
931DW	14

Corbin/Ruswin I.C. Core	Page
CR1125RD	16
CR1125RL	16

Best-Style (small format) I.C. Core	Page
Cores for SFIC Locks	17
720	18
721	18
722	18
723	18
725MD	19
725ML	19
725RD	19
725RL	19
728MBL	19
729R	20
950IC	20

Olympus 2000 Handle	Page
Handle Accessories	24
For Small Pin Locks	25
For Large Pin Locks	25

Pin Kits & Pin Accessories	Page
N1	23
R1	23
Replacement Pins	23

Keying/Finishes	Page
Keying Charges	26
Cut Keys	26
Keyblanks	26
Custom Lock Plating	26
Finish Chart	27

Parts & Accessories	Page
Additional Cabinet Lock Parts	27
Cabinet Lock Drill Guide	20
Olympus Display Boards	23
Spacers & Trim	21
Strikes	22

Padlocks	Page
Detailed Specifications	28
Mountain Series (Blister Packed)	29
Olympus Series (Boxed)	29
Rekeyable (Schlage or Weiser Keyway)	29
Rekeyable Padlock Keying Charges	29
Corbin/Ruswin IC Core	29
Padlock Keyblanks	30



REPLACEMENT GUIDE & HANDING CHART

** Information given is for dimensional and keyway replacement only. Olympus Lock cabinet locks differ from other manufacturer's locks because they are covered by at least two patents and are easily rekeyable in five minutes or less with readily available tools.

National Cabinet Lock			Olympus Lock **		
C8102	Cam Lock	1-1/16"	DCN1	Cam Lock	1-1/16"
C8103	Cam Lock	1-3/16"	DCN2	Cam Lock	1-3/16"
C8106	Cam Lock	1-7/16"	DCN3	Cam Lock	1-7/16"
C8108	Cam Lock	1-3/4"	DCN4	Cam Lock	1-3/4"
C8109	Cam Lock	1-3/4"	DCN4	Cam Lock	1-3/4"
C8131	Drawer Latch	7/8"	998	Drawer Latch	7/8"
Not Available			998	Drawer Latch	1-3/8"
C8139	Door Latch	3/4"	999	Door Latch	7/8"
Not Available			999	Door Latch	1-3/8"
C8140	Ratchet Lock	1/4"	329R	Ratchet Lock	1/4"
C8137	T-Bolt Lock	1/4"	T37	T-Bolt Lock	1/4"
C8173	Door Lock	7/8"	100DR	Door Lock	7/8"
C8174	Door Lock	1-1/8"	100DR	Door Lock	1-3/8"
C8175	Door Lock	1-3/8"	100DR	Door Lock	1-3/8"
C8178	Drawer Lock	7/8"	200DW	Drawer Lock	7/8"
C8177	Drawer Lock	1-1/8"	200DW	Drawer Lock	1-3/8"
C8179	Drawer Lock	1-3/8"	200DW	Drawer Lock	1-3/8"
Not Available			200DW	Drawer Lock	1-5/8"
C8142	Sliding Door	1-1/8"	300SD	Sliding Door	1-1/8"
C8163	Drawer Lock	7/8"	N078	Drawer	1-1/8"
Not Available			N078	Drawer	1-3/8"
Not Available			N078L/R	Door	1-1/8"
Not Available			N078L/R	Door	1-3/8"

Corbin/CCL Sec. Prod.			Olympus Lock **		
15748	Cam Lock	5/8"	DCR1	Cam Lock	1-1/16"
15749	Cam Lock	13/16"	DCR1	Cam Lock	1-1/16"
15750	Cam Lock	1"	DCR1	Cam Lock	1-1/16"
15783	Cam Lock	1"	DCR1	Cam Lock	1-1/16"
15890	Cam Lock	1-5/16"	DCR3	Cam Lock	1-7/16"
0666 1/2	Drawer Latch	7/8"	996	Drawer Latch	7/8"
0666 1/2	Drawer Latch	1-1/8"	996	Drawer Latch	1-3/8"
Not Available			997	Door Latch	7/8"
Not Available			997	Door Latch	1-3/8"
0737	Door Lock	3/4"	500DR	Door Lock	7/8"
0737	Door Lock	7/8"	500DR	Door Lock	7/8"
0737	Door Lock	1-1/8"	500DR	Door Lock	1-3/8"
0737	Door Lock	1-3/8"	500DR	Door Lock	1-3/8"
0738	Drawer Lock	3/4"	600DW	Drawer Lock	7/8"
0738	Drawer Lock	7/8"	600DW	Drawer Lock	7/8"
0738	Drawer Lock	1-1/8"	600DW	Drawer Lock	1-3/8"
0738	Drawer Lock	1-3/8"	600DW	Drawer Lock	1-3/8"
02063	Drawer Lock	7/8"	R078	Drawer Lock	1-1/8"
02291	Sliding Door	7/8"	400SD	Sliding Door	1"
Not Available			429R	Ratchet Lock	1/4"

Best Lock		Olympus Lock	
Best	3L7RD2	Olympus	721DW **
Best	5L7RD2	Olympus	725RD-DW-VH
Best	5L7RD3	Olympus	725RD-DR-RH
Best	5L7RD4	Olympus	725RD-DR-LH
Best	5L7RD5	Olympus	725RD-DW-IH
Best	5L7RL2	Olympus	725RL-DW-VH
Best	5L7RL3	Olympus	725RL-DR-RH
Best	5L7RL4	Olympus	725RL-DR-LH
Best	5L7RL5	Olympus	725RL-DW-IH
Best	5L7MD2	Olympus	725MD-DW-VH
Best	5L7MD3	Olympus	725MD-DR-RH
Best	5L7MD4	Olympus	725MD-DR-LH
Best	5L7MD5	Olympus	725MD-DW-IH
Best	5L7ML2	Olympus	725ML-DW-VH
Best	5L7ML3	Olympus	725ML-DR-RH
Best	5L7ML4	Olympus	725ML-DR-LH
Best	5L7ML5	Olympus	725ML-DW-IH
Best	8L	Olympus	728MBL
Best	1E7D4, 1E7E4	Olympus	720
Best	2S	Olympus	722
Best	2S-TBM	Olympus	722-TBM
Best	3S	Olympus	729R
Best	4S	Olympus	723S

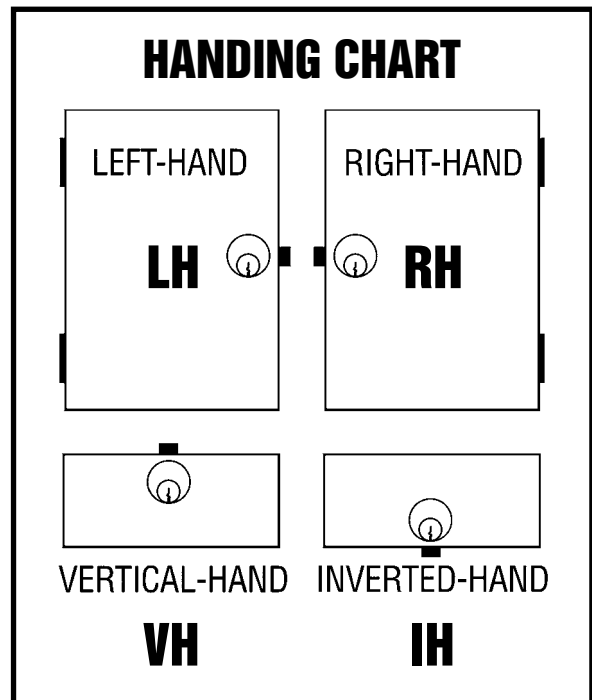



NATIONAL KEYWAY CABINET LOCKS

General Information

Keyway: National D4291(4-pin) or D4292 (5-pin) keyway
 KD/KA: 4 pin standard
 Stock KA Nos. 101, 103, 107, 915
 Master keyed: 5 pin standard
 Pin Kit: Use N1 Pin Kit for rekeying
 Keyblanks: 4-pin use KBN-4-NP, 5-pin use KBN-5-NP

Finishes: For finishes not listed, see charges under "custom finishes" in this price list or consult factory.
 Accessories: Additional accessories are available for these products. See the accessories section or consult factory.
 Grand master keyed: Add \$2.00 to the custom, non-stock or master keyed list price.

100DR • Door Deadbolt

Packed 10/Box



Part #	Finish	Fits Material	Pinning	Pin Tumbler Keying	Weight	Price Each
100DR	26D, US4	7/8"	4 pin	KD, KA 101,103,107,915	4.85 lbs/box	\$26.20
100DR	26D, US4	7/8"	5 pin	Custom, non-stock or master keyed	4.85 lbs/box	\$28.60
100DR	26D, US4	1-3/8"	4 pin	KD, KA 101,103,107,915	5.6 lbs/box	\$26.20
100DR	26D, US4	1-3/8"	5 pin	Custom, non-stock or master keyed	5.6 lbs/box	\$28.60

Add \$20.00 to above prices for US10B finish.

200DW • Drawer Deadbolt

Packed 10/Box



Part #	Finish	Fits Material	Pinning	Pin Tumbler Keying	Weight	Price Each
200DW	26D, US4	7/8"	4 pin	KD, KA 101,103,107,915	4.85 lbs/box	\$26.20
200DW	26D, US4	7/8"	5 pin	Custom, non-stock or master keyed	4.85 lbs/box	\$28.60
200DW	26D, US4	1-3/8"	4 pin	KD, KA 101,103,107,915	5.6 lbs/box	\$26.20
200DW	26D, US4	1-3/8"	5 pin	Custom, non-stock or master keyed	5.6 lbs/box	\$28.60
200DW	26D	1-5/8"	4 pin	KD, KA 101,103,107,915	6.0 lbs/box	\$28.90
200DW	26D	1-5/8"	5 pin	Custom, non-stock or master keyed	6.0 lbs/box	\$31.30

Add \$20.00 to above prices for US10B finish.

300SD • Sliding Door Push Lock

Packed 10/Box



Part #	Finish	Fits Material	Pinning	Pin Tumbler Keying	Weight	Price Each
300SD	26D, US3	1"	4 pin	KD, KA 101,103,107,915	2.8 lbs/box	\$37.00
300SD	26D, US3	1"	5 pin	Custom, non-stock or master keyed	2.8 lbs/box	\$39.40

Add \$20.00 to above prices for US10B finish.

329R • Sliding Door Ratchet Lock

Packed 10/Box



NEW!

Part #	Finish	Fits Material	Pinning	Pin Tumbler Keying	Price Each
329R	26D	For 1/4" panels	4 pin	KD, KA 101,103,107,915	\$37.00
329R	26D	For 1/4" panels	5 pin	Custom, non-stock or master keyed	\$39.40

New item! Available 4th quarter 2008. Use in place of National C8140.



NATIONAL KEYWAY CABINET LOCKS

N078 • Drawer Deadbolt

Packed 10/Box



Part #	Handing	Finish	Fits Mat.	Pinning	Pin Tumbler Keying	Weight	Price Each
N078	VH	26D, US4	1-1/8"	4 pin	KD, KA 101,103,107,915	3.1 lbs/box	\$21.80
N078	VH	26D, US4	1-1/8"	5 pin	Custom, non-stock or master keyed	3.1 lbs/box	\$24.20
N078	VH	26D, US4	1-3/8"	4 pin	KD, KA 101,103,107,915	3.6 lbs/box	\$23.80
N078	VH	26D, US4	1-3/8"	5 pin	Custom, non-stock or master keyed	3.6 lbs/box	\$26.20

N078 • Door Deadbolt

Packed 10/Box



N078R
RH=right-hand



N078L
LH=left-hand

Part #	Handing	Finish	Fits Mat.	Pinning	Pin Tumbler Keying	Weight	Price Each
N078R	RH	26D, US4	1-1/8"	4 pin	KD, KA 101,103,107,915	3.1 lbs/box	\$21.80
N078R	RH	26D, US4	1-1/8"	5 pin	Custom, non-stock or master keyed	3.1 lbs/box	\$24.20
N078R	RH	26D, US4	1-3/8"	4 pin	KD, KA 101,103,107,915	3.6 lbs/box	\$23.80
N078R	RH	26D, US4	1-3/8"	5 pin	Custom, non-stock or master keyed	3.6 lbs/box	\$26.20
N078L	LH	26D, US4	1-1/8"	4 pin	KD, KA 101,103,107,915	3.1 lbs/box	\$21.80
N078L	LH	26D, US4	1-1/8"	5 pin	Custom, non-stock or master keyed	3.1 lbs/box	\$24.20
N078L	LH	26D, US4	1-3/8"	4 pin	KD, KA 101,103,107,915	3.6 lbs/box	\$23.80
N078L	LH	26D, US4	1-3/8"	5 pin	Custom, non-stock or master keyed	3.6 lbs/box	\$26.20

078-LB-DR	Optional 1/4" longer bolt for N078 door locks	Each	\$1.80
-----------	---	------	--------

VERTICAL-HAND (VH) = Drawer with bolt locking up
INVERTED-HAND (IH) = Drawer with bolt locking down

RIGHT-HAND (RH) = Door hinged on right
LEFT-HAND (LH) = Door hinged on left

DCN • Cam Lock

Packed 10/Box



Part #	Finish	Cyl. Length	Pinning	Pin Tumbler Keying	Weight	Price Each
DCN1	26D, US3	1-1/16"	4 pin	KD, KA 101,103,107,915	2.5 lbs/box	\$19.80
DCN1	26D, US3	1-1/16"	5 pin	Custom, non-stock or master keyed	2.5 lbs/box	\$22.20
DCN2	26D, US3	1-3/16"	4 pin	KD, KA 101,103,107,915	2.6 lbs/box	\$19.80
DCN2	26D, US3	1-3/16"	5 pin	Custom, non-stock or master keyed	2.6 lbs/box	\$22.20
DCN3	26D, US3	1-7/16"	4 pin	KD, KA 101,103,107,915	2.8 lbs/box	\$19.80
DCN3	26D, US3	1-7/16"	5 pin	Custom, non-stock or master keyed	2.8 lbs/box	\$22.20
DCN4	26D, US3	1-3/4"	4 pin	KD, KA 101,103,107,915	3.1 lbs/box	\$19.80
DCN4	26D, US3	1-3/4"	5 pin	Custom, non-stock or master keyed	3.1 lbs/box	\$22.20

Add \$16.00 to above prices for US10B finish.

Additional Cams	*DCNP-100-SC, *DCNP-100-BC, DCNP-100-LC, DCNP-100-LBC, DCNP-100-BC5, DCNP-100-WB	Packed Each	\$1.50
Finger Pull	DCNP-300-FP	Packed Each	\$1.87
Key-retaining drivers	DCNP-200-KR (Drawer), DCNP-200-KDR (Door)	Packed Each	\$1.43
Number plate ring	T37DC-NP	Packed Each	\$0.56

DCN ships standard with DCNP-500-ARP (anti-rotation plate) and *DCNP-100-SC (straight cam) and *DCNP-100-BC (reversible bent cam).



NATIONAL KEYWAY CABINET LOCKS

998 • Drawer Latch

Packed 10/Box



998V
VH=vertical-hand



998I
IH=inverted-hand

Part #	Handing	Finish	Fits Mat.	Pinning	Pin Tumbler Keying	Weight	Price Each
998V	VH	26D, US4	7/8"	4 pin	KD, KA 101,103,107,915	4.9 lbs/box	\$43.40
998V	VH	26D, US4	7/8"	5 pin	Custom, non-stock or master keyed	4.9 lbs/box	\$45.80
998V	VH	26D, US4	1-3/8"	4 pin	KD, KA 101,103,107,915	5.7 lbs/box	\$43.40
998V	VH	26D, US4	1-3/8"	5 pin	Custom, non-stock or master keyed	5.7 lbs/box	\$45.80
998I	IH	26D, US4	7/8"	4 pin	KD, KA 101,103,107,915	4.9 lbs/box	\$43.40
998I	IH	26D, US4	7/8"	5 pin	Custom, non-stock or master keyed	4.9 lbs/box	\$45.80
998I	IH	26D, US4	1-3/8"	4 pin	KD, KA 101,103,107,915	5.7 lbs/box	\$43.40
998I	IH	26D, US4	1-3/8"	5 pin	Custom, non-stock or master keyed	5.7 lbs/box	\$45.80

999 • Door Latch

Packed 10/Box



999R
RH=right-hand



999L
LH=left-hand

Part #	Handing	Finish	Fits Mat.	Pinning	Pin Tumbler Keying	Weight	Price Each
999R	RH	26D, US4	7/8"	4 pin	KD, KA 101,103,107,915	4.9 lbs/box	\$43.40
999R	RH	26D, US4	7/8"	5 pin	Custom, non-stock or master keyed	4.9 lbs/box	\$45.80
999R	RH	26D, US4	1-3/8"	4 pin	KD, KA 101,103,107,915	5.7 lbs/box	\$43.40
999R	RH	26D, US4	1-3/8"	5 pin	Custom, non-stock or master keyed	5.7 lbs/box	\$45.80
999L	LH	26D, US4	7/8"	4 pin	KD, KA 101,103,107,915	4.9 lbs/box	\$43.40
999L	LH	26D, US4	7/8"	5 pin	Custom, non-stock or master keyed	4.9 lbs/box	\$45.80
999L	LH	26D, US4	1-3/8"	4 pin	KD, KA 101,103,107,915	5.7 lbs/box	\$43.40
999L	LH	26D, US4	1-3/8"	5 pin	Custom, non-stock or master keyed	5.7 lbs/box	\$45.80

VERTICAL-HAND (VH) = Drawer with bolt locking up
INVERTED-HAND (IH) = Drawer with bolt locking down

RIGHT-HAND (RH) = Door hinged on right
LEFT-HAND (LH) = Door hinged on left

T37 • T-Bolt Lock

Packed 10/Box



T37
T-Bolt Lock

Part #	Finish	Fits Mat.	Pinning	Pin Tumbler Keying	Weight	Price Each
T37	26D	1/4"	4 pin	KD, KA 101,103,107,915	2.0 lbs/box	\$23.15
T37	26D	1/4"	4 pin	KA 001 through 030	2.0 lbs/box	\$23.15
T37	26D	1/4"	4 pin	Custom, non-stock or master keyed	2.0 lbs/box	\$25.43
T37-1		Standard bolt (requires bolt spring sold separately)			Packed Each	\$6.44
T37-2		Optional long bolt (requires bolt spring sold separately)			Packed Each	\$10.58
T37-RC		Optional spring mounting clip			Packed Each	\$1.10
T37-SP		Replacement bolt spring			Packed Each	\$0.36
T37-TR		Replacement trim collar (standard)			Packed Each	\$2.10
T37-NKIT		Number plate kit for T37 (Includes below 2 items)			Packed Each	\$2.66
T37DC-NP		Number plate only			Packed Each	\$0.56
T37-TR2		Trim collar for use with number plates			Packed Each	\$2.10

T37 ships standard with brass fixing nut and standard bolt.



CCL KEYWAY CABINET LOCKS

General Information

Keyway: CCL R1 Keyway (5-pin), 6-pin keying available
 KD/KA: 5 pin standard
 Stock KA Nos. 4T21579, 4T37526
 Master keyed: 5 pin standard
 Pin Kit: Use R1 Pin Kit for rekeying
 Keyblanks: 5-pin use KBR-5-NP, 6-pin use KBR-6

Finishes: For finishes not listed, see charges under "custom finishes" in this price list or consult factory.
 Accessories: Additional accessories are available for these products. See the accessories section or consult factory.
 Grand master keyed or 6-pin keying: Add \$2.00 to the custom, non-stock or master keyed list price.

500DR • Door Deadbolt

Packed 10/Box



Part #	Finish	Fits Material	Pinning	Pin Tumbler Keying	Weight	Price Each
500DR	26D, US4	7/8"	5 pin	KD, KA 4T21579, 4T37526	4.85 lbs/box	\$33.60
500DR	26D, US4	7/8"	5 pin	Custom, non-stock or master keyed	4.85 lbs/box	\$37.40
500DR	26D, US4	1-3/8"	5 pin	KD, KA 4T21579, 4T37526	5.6 lbs/box	\$33.60
500DR	26D, US4	1-3/8"	5 pin	Custom, non-stock or master keyed	5.6 lbs/box	\$37.40

Add \$20.00 to above prices for US10B finish.

600DW • Drawer Deadbolt

Packed 10/Box



Part #	Finish	Fits Material	Pinning	Pin Tumbler Keying	Weight	Price Each
600DW	26D, US4	7/8"	5 pin	KD, KA 4T21579, 4T37526	4.85 lbs/box	\$33.60
600DW	26D, US4	7/8"	5 pin	Custom, non-stock or master keyed	4.85 lbs/box	\$37.40
600DW	26D, US4	1-3/8"	5 pin	KD, KA 4T21579, 4T37526	5.6 lbs/box	\$33.60
600DW	26D, US4	1-3/8"	5 pin	Custom, non-stock or master keyed	5.6 lbs/box	\$37.40

Add \$20.00 to above prices for US10B finish.

400SD • Sliding Door Push Lock

Packed 10/Box



Part #	Finish	Fits Material	Pinning	Pin Tumbler Keying	Weight	Price Each
400SD	26D, US3	1"	5 pin	KD, KA 4T21579, 4T37526	2.8 lbs/box	\$41.00
400SD	26D, US3	1"	5 pin	Custom, non-stock or master keyed	2.8 lbs/box	\$44.80

Add \$20.00 to above prices for US10B finish.

429R • Sliding Door Ratchet Lock

Packed 10/Box



Part #	Finish	Fits Material	Pinning	Pin Tumbler Keying	Price Each
429R	26D	For 1/4" panels	5 pin	KD, KA 4T21579, 4T37526	\$41.00
429R	26D	For 1/4" panels	5 pin	Custom, non-stock or master keyed	\$44.80

New item! Available 4th quarter 2008.

R078 • Door Deadbolt

Packed 10/Box



Part #	Finish	Fits Material	Pinning	Pin Tumbler Keying	Weight	Price Each
R078	26D, US4	1"	5 pin	KD, KA 4T21579, 4T37526	3.1 lbs/box	\$25.40
R078	26D, US4	1"	5 pin	Custom, non-stock or master keyed	3.1 lbs/box	\$29.20



CCL KEYWAY CABINET LOCKS

996 • Drawer Latch

Packed 10/Box



996V
VH=vertical-hand



996I
IH=inverted-hand

Part #	Handing	Finish	Fits Mat.	Pinning	Pin Tumbler Keying	Weight	Price Each
996V	VH	26D, US4	7/8"	5 pin	KD, KA 4T21579, 4T37526	4.9 lbs/box	\$48.80
996V	VH	26D, US4	7/8"	5 pin	Custom, non-stock or master keyed	4.9 lbs/box	\$52.60
996V	VH	26D, US4	1-3/8"	5 pin	KD, KA 4T21579, 4T37526	5.6 lbs/box	\$48.80
996V	VH	26D, US4	1-3/8"	5 pin	Custom, non-stock or master keyed	5.6 lbs/box	\$52.60
996I	IH	26D, US4	7/8"	5 pin	KD, KA 4T21579, 4T37526	4.9 lbs/box	\$48.80
996I	IH	26D, US4	7/8"	5 pin	Custom, non-stock or master keyed	4.9 lbs/box	\$52.60
996I	IH	26D, US4	1-3/8"	5 pin	KD, KA 4T21579, 4T37526	5.6 lbs/box	\$48.80
996I	IH	26D, US4	1-3/8"	5 pin	Custom, non-stock or master keyed	5.6 lbs/box	\$52.60

997 • Door Latch

Packed 10/Box



997R
RH=right-hand



997L
LH=left-hand

Part #	Handing	Finish	Fits Mat.	Pinning	Pin Tumbler Keying	Weight	Price Each
997R	RH	26D, US4	7/8"	5 pin	KD, KA 4T21579, 4T37526	4.9 lbs/box	\$48.80
997R	RH	26D, US4	7/8"	5 pin	Custom, non-stock or master keyed	4.9 lbs/box	\$52.60
997R	RH	26D, US4	1-3/8"	5 pin	KD, KA 4T21579, 4T37526	5.6 lbs/box	\$48.80
997R	RH	26D, US4	1-3/8"	5 pin	Custom, non-stock or master keyed	5.6 lbs/box	\$52.60
997L	LH	26D, US4	7/8"	5 pin	KD, KA 4T21579, 4T37526	4.9 lbs/box	\$48.80
997L	LH	26D, US4	7/8"	5 pin	Custom, non-stock or master keyed	4.9 lbs/box	\$52.60
997L	LH	26D, US4	1-3/8"	5 pin	KD, KA 4T21579, 4T37526	5.6 lbs/box	\$48.80
997L	LH	26D, US4	1-3/8"	5 pin	Custom, non-stock or master keyed	5.6 lbs/box	\$52.60

VERTICAL-HAND (VH) = Drawer with bolt locking up
INVERTED-HAND (IH) = Drawer with bolt locking down

RIGHT-HAND (RH) = Door hinged on right
LEFT-HAND (LH) = Door hinged on left

DCR • Cam Lock

Packed 10/Box



Part #	Finish	Cyl. Length	Pinning	Pin Tumbler Keying	Weight	Price Each
DCR1	26D, US3	1-1/16"	5 pin	KD, KA 4T21579, 4T37526	2.5 lbs/box	\$25.00
DCR1	26D, US3	1-1/16"	5 pin	Custom, non-stock or master keyed	2.5 lbs/box	\$28.80
DCR2	26D, US3	1-3/16"	5 pin	KD, KA 4T21579, 4T37526	2.6 lbs/box	\$25.00
DCR2	26D, US3	1-3/16"	5 pin	Custom, non-stock or master keyed	2.6 lbs/box	\$28.80
DCR3	26D, US3	1-7/16"	5 pin	KD, KA 4T21579, 4T37526	2.8 lbs/box	\$25.00
DCR3	26D, US3	1-7/16"	5 pin	Custom, non-stock or master keyed	2.8 lbs/box	\$28.80
DCR4	26D, US3	1-3/4"	5 pin	KD, KA 4T21579, 4T37526	3.1 lbs/box	\$25.00
DCR4	26D, US3	1-3/4"	5 pin	Custom, non-stock or master keyed	3.1 lbs/box	\$28.80

Additional Cams *DCNP-100-SC, *DCNP-100-BC, DCNP-100-LC, DCNP-100-LBC, DCNP-100-BC5, DCNP-100-WB Packed Each \$1.50

Finger Pull DCNP-300-FP Packed Each \$1.87

Key-retaining drivers DCNP-200-KR (Drawer), DCNP-200-KDR (Door) Packed Each \$1.43

Number plate ring T37DC-NP Packed Each \$0.56

DCR ships standard with DCNP-500-ARP (anti-rotation plate) and *DCNP-100-SC (straight cam) and *DCNP-100-BC (reversible bent cam).



SCHLAGE C KEYWAY CABINET LOCKS

General Information

Keyway: Schlage C keyway
 Cylinder: 6 pin solid brass cylinder
 KD/KA: 5 pin keyed alike or keyed different
 Stock KA Nos. 101, 102
 Master keyed: 5 pin standard, 6 pin available

Finishes: For finishes not listed, see charges under "custom finishes" in this price list or consult factory.

Accessories: Additional accessories are available for these products. See accessories section or consult factory.

Grand master keyed or 6-pin keying: Add \$2.00 to the custom, non-stock or master keyed list price.

700SC • Door Deadbolt

Packed 10/Box



Part #	Finish	Fits Mat.	Cylinder	Pin Tumbler Keying (5-pin)	Weight	Price Each
700S	26D, US3	1-1/8"	6 pin	KD, KA 101, 102, O-BIT	7.4 lbs/box	\$51.20
700S	26D, US3	1-1/8"	6 pin	Custom, non-stock or master keyed	7.4 lbs/box	\$57.00
700S	26D, US3	1-3/8"	6 pin	KD, KA 101, 102, O-BIT	7.4 lbs/box	\$52.50
700S	26D, US3	1-3/8"	6 pin	Custom, non-stock or master keyed	7.4 lbs/box	\$58.30

Add \$16.00 to above prices for US10B finish.

Key-Retaining Function

Packed 10/Box

Part #	Handing	Finish	Fits Mat.	Cylinder	Pin Tumbler Keying (5-pin)	Weight	Price Each
700KL	LH	26D, US3	1-1/8"	6 pin	KD, KA 101, 102, O-BIT	7.4 lbs/box	\$56.20
700KL	LH	26D, US3	1-1/8"	6 pin	Custom, non-stock or master keyed	7.4 lbs/box	\$62.00
700KL	LH	26D, US3	1-3/8"	6 pin	KD, KA 101, 102, O-BIT	7.4 lbs/box	\$57.50
700KL	LH	26D, US3	1-3/8"	6 pin	Custom, non-stock or master keyed	7.4 lbs/box	\$63.30
700KR	RH	26D, US3	1-1/8"	6 pin	KD, KA 101, 102, O-BIT	7.4 lbs/box	\$56.20
700KR	RH	26D, US3	1-1/8"	5 pin	Custom, non-stock or master keyed	7.4 lbs/box	\$62.00
700KR	RH	26D, US3	1-3/8"	6 pin	KD, KA 101, 102, O-BIT	7.4 lbs/box	\$57.50
700KR	RH	26D, US3	1-3/8"	6 pin	Custom, non-stock or master keyed	7.4 lbs/box	\$63.30

Add \$16.00 to above prices for US10B finish.

800SC • Drawer Deadbolt

Packed 10/Box



Part #	Finish	Fits Mat.	Cylinder	Pin Tumbler Keying (5-pin)	Weight	Price Each
800S	26D, US3	1-1/8"	6 pin	KD, KA 101, 102, O-BIT	7.4 lbs/box	\$51.20
800S	26D, US3	1-1/8"	6 pin	Custom, non-stock or master keyed	7.4 lbs/box	\$57.00
800S	26D, US3	1-3/8"	6 pin	KD, KA 101, 102, O-BIT	7.4 lbs/box	\$52.50
800S	26D, US3	1-3/8"	6 pin	Custom, non-stock or master keyed	7.4 lbs/box	\$58.30

Add \$16.00 to above prices for US10B finish.

Key-Retaining Function

Packed 10/Box

Part #	Handing	Finish	Fits Mat.	Cylinder	Pin Tumbler Keying (5-pin)	Weight	Price Each
800KV	VH	26D, US3	1-1/8"	6 pin	KD, KA 101, 102, O-BIT	7.4 lbs/box	\$56.20
800KV	VH	26D, US3	1-1/8"	6 pin	Custom, non-stock or master keyed	7.4 lbs/box	\$62.00
800KV	VH	26D, US3	1-3/8"	6 pin	KD, KA 101, 102, O-BIT	7.4 lbs/box	\$57.50
800KV	VH	26D, US3	1-3/8"	6 pin	Custom, non-stock or master keyed	7.4 lbs/box	\$63.30
800KI	IH	26D, US3	1-1/8"	6 pin	KD, KA 101, 102, O-BIT	7.4 lbs/box	\$56.20
800KI	IH	26D, US3	1-1/8"	6 pin	Custom, non-stock or master keyed	7.4 lbs/box	\$62.00
800KI	IH	26D, US3	1-3/8"	6 pin	KD, KA 101, 102, O-BIT	7.4 lbs/box	\$57.50
800KI	IH	26D, US3	1-3/8"	6 pin	Custom, non-stock or master keyed	7.4 lbs/box	\$63.30

Add \$16.00 to above prices for US10B finish.

VERTICAL-HAND (VH) = Drawer with bolt locking up
 INVERTED-HAND (IH) = Drawer with bolt locking down

RIGHT-HAND (RH) = Door hinged on right
 LEFT-HAND (LH) = Door hinged on left



SCHLAGE C KEYWAY CABINET LOCKS

820 • Cam Lock

Packed 10/Box



Part #	Finish	Cyl. Length	Cylinder	Pin Tumbler Keying (5-pin)	Weight	Price Each
820S	26D, US3	1-23/32"	6 pin	KD, KA 101, 102	6.2 lbs/box	\$52.30
820S	26D, US3	1-23/32"	6 pin	Custom, non-stock or master keyed	6.2 lbs/box	\$58.10

Due to overall length of cylinder, installation may require use of trim collar. See page 21 for details.

Additional Cams	*720-3-1, *720-3-2, 720-3-3, 720-3-4, 720-3-5	\$2.20
Trim Collars	TR201, TR202, TR203, TR200A	See page 21
SW-1	Switch accessory pack	\$8.45

*Ships standard with 720-PL3 (anti-rotation plate), lost-motion and key retaining door/drawer drivers, and 720-3-1 and 720-3-2 cams. Additional cams available separately.

850S • Deadlatching Drawer

Packed 10/Box



Part #	Finish	Fits Material	Cylinder	Pin Tumbler Keying (5-pin)	Weight	Price Each
850S	26D, US3	1-1/8"	6 pin	KD, KA 101, 102	8.3 lbs/box	\$62.40
850S	26D, US3	1-1/8"	6 pin	Custom, non-stock or master keyed	8.3 lbs/box	\$68.20
850S	26D, US3	1-3/8"	6 pin	KD, KA 101, 102	8.5 lbs/box	\$66.00
850S	26D, US3	1-3/8"	6 pin	Custom, non-stock or master keyed	8.5 lbs/box	\$71.80

L7080 • Drawer Latch

Packed 10/Box



L78V
VH=vertical-hand



L78I
IH=inverted-hand

Part #	Handing	Finish	Fits Mat.	Cylinder	Pin Tumbler Keying (5-pin)	Weight	Price Each
L78V	VH	26D, US3	1-1/8"	6 pin	KD, KA 101, 102	8.6 lbs/box	\$64.80
L78V	VH	26D, US3	1-1/8"	6 pin	Custom, non-stock or master keyed	8.6 lbs/box	\$70.60
L78V	VH	26D, US3	1-3/8"	6 pin	KD, KA 101, 102	9.1 lbs/box	\$66.10
L78V	VH	26D, US3	1-3/8"	6 pin	Custom, non-stock or master keyed	9.1 lbs/box	\$71.90
L78I	IH	26D, US3	1-1/8"	6 pin	KD, KA 101, 102	8.6 lbs/box	\$64.80
L78I	IH	26D, US3	1-1/8"	6 pin	Custom, non-stock or master keyed	8.6 lbs/box	\$70.60
L78I	IH	26D, US3	1-3/8"	6 pin	KD, KA 101, 102	9.1 lbs/box	\$66.10
L78I	IH	26D, US3	1-3/8"	6 pin	Custom, non-stock or master keyed	9.1 lbs/box	\$71.90
L78-KNOB		26D, US3	Emergency inside-release knob				\$1.87

Emergency release knob allows latch to be retracted from inside of door.

L7080 • Door Latch

Packed 10/Box



L78R
RH=right-hand



L78L
LH=left-hand

Part #	Handing	Finish	Fits Mat.	Cylinder	Pin Tumbler Keying (5-pin)	Weight	Price Each
L78R	RH	26D, US3	1-1/8"	6 pin	KD, KA 101, 102	8.6 lbs/box	\$64.80
L78R	RH	26D, US3	1-1/8"	6 pin	Custom, non-stock or master keyed	8.6 lbs/box	\$70.60
L78R	RH	26D, US3	1-3/8"	6 pin	KD, KA 101, 102	9.1 lbs/box	\$66.10
L78R	RH	26D, US3	1-3/8"	6 pin	Custom, non-stock or master keyed	9.1 lbs/box	\$71.90
L78L	LH	26D, US3	1-1/8"	6 pin	KD, KA 101, 102	8.6 lbs/box	\$64.80
L78L	LH	26D, US3	1-1/8"	6 pin	Custom, non-stock or master keyed	8.6 lbs/box	\$70.60
L78L	LH	26D, US3	1-3/8"	6 pin	KD, KA 101, 102	9.1 lbs/box	\$66.10
L78L	LH	26D, US3	1-3/8"	6 pin	Custom, non-stock or master keyed	9.1 lbs/box	\$71.90
L78-KNOB		26D, US3	Emergency inside-release knob				\$1.87

Emergency release knob allows latch to be retracted from inside of door.

VERTICAL-HAND (VH) = Drawer with bolt locking up

INVERTED-HAND (IH) = Drawer with bolt locking down

RIGHT-HAND (RH) = Door hinged on right

LEFT-HAND (LH) = Door hinged on left



SCHLAGE CABINET LOCKS - LESS CYLINDER

General Information

Schlage: Chambers both standard or Primus/ Everest Schlage original key-in-knob cylinders.

Compatibility: Accepts third-party Schlage-compatible key-in-knob style cylinders including Kaba, Mul-T-Lock, Videx, Cliq.

Assa: Requires use of 1-3/8" lock. Works with ASSA cylinder #65611.

Medeco: Requires use of 1-3/8" lock.

6 pin #20-009S4

5 pin #20-008S4

Biaxial: 6 pin #20W009S4

5 pin #20W008S4

Keymark: 6 pin #20K009S4

Key retaining: #20W200S1

Finishes: For finishes not listed, see charges under "custom finishes" in this price list or consult factory.

Accessories: Additional accessories are available for these products. See accessories section or consult factory.

700LC • Door Deadbolt

Packed 10/Box



Part #	Finish	Fits Mat.	Cylinder	Description	Weight	Price Each
700LCA	26D, US3	1-1/8"	n/a	Less cylinder	5.6 lbs/box	\$42.70
700LCM	26D, US3	1-3/8"	n/a	Less cylinder	5.8 lbs/box	\$44.00

Add \$16.00 to above prices for US10B finish.

78-KABA-CONV	Conversion kit for KABA cylinders	Each	\$4.73
--------------	-----------------------------------	------	--------

800LC • Drawer Deadbolt

Packed 10/Box



Part #	Finish	Fits Mat.	Cylinder	Description	Weight	Price Each
800LCA	26D, US3	1-1/8"	n/a	Less cylinder	5.6 lbs/box	\$42.70
800LCM	26D, US3	1-3/8"	n/a	Less cylinder	5.8 lbs/box	\$44.00

Add \$16.00 to above prices for US10B finish.

78-KABA-CONV	Conversion kit for KABA cylinders	Each	\$4.73
--------------	-----------------------------------	------	--------

820LC • Cam Lock

Packed 10/Box



Part #	Finish	Cyl. Length	Cylinder	Description	Weight	Price Each
820LC	26D, US3	1-23/32"	n/a	Less cylinder	4.5 lbs/box	\$43.80

Due to overall length of cylinder, installation may require use of trim collar. See page 21 for details.

Additional Cams	*720-3-1, *720-3-2, 720-3-3, 720-3-4, 720-3-5	\$2.20
Trim Collars	TR201, TR202, TR203, TR200A	See page 21
SW-1	Switch accessory pack	\$8.45

*The 820 comes standard with 720-PL3 (anti-rotation plate), lost-motion and key retaining door/drawer drivers, and 720-3-1 and 720-3-2 cams. Additional cams available separately. This lock will not accept Medeco cylinders.

850LC • Deadlatching Drawer

Packed 10/Box



Part #	Finish	Fits Mat.	Cylinder	Description	Weight	Price Each
850LCA	26D, US3	1-1/8"	n/a	Less cylinder	6.7 lbs/box	\$53.90
850LCM	26D, US3	1-3/8"	n/a	Less cylinder	6.9 lbs/box	\$57.50



SCHLAGE CABINET LOCKS - LESS CYLINDER

L78LC • Drawer Latch

Packed 10/Box



L78V
VH=vertical-hand



L78I
IH=inverted-hand

Part #	Handing	Finish	Fits Mat.	Cylinder	Description	Weight	Price Each
L78V-LCA	VH	26D, US3	1-1/8"	n/a	Less cylinder, VH Drawer	7.0 lbs/box	\$56.30
L78V-LCM	VH	26D, US3	1-3/8"	n/a	Less cylinder, VH Drawer	7.4 lbs/box	\$57.60
L78I-LCA	IH	26D, US3	1-1/8"	n/a	Less cylinder, IH Drawer	7.0 lbs/box	\$56.30
L78I-LCM	IH	26D, US3	1-3/8"	n/a	Less cylinder, IH Drawer	7.4 lbs/box	\$57.60

L78-KNOB	26D, US3	Emergency inside-release knob					\$1.87
----------	----------	-------------------------------	--	--	--	--	--------

Emergency release knob allows latch to be retracted from inside of door.

L78LC • Door Latch

Packed 10/Box



L78R
RH=right-hand



L78L
LH=left-hand

Part #	Handing	Finish	Fits Mat.	Cylinder	Description	Weight	Price Each
L78R-LCA	RH	26D, US3	1-1/8"	n/a	Less cylinder, RH Door	7.0 lbs/box	\$56.30
L78R-LCM	RH	26D, US3	1-3/8"	n/a	Less cylinder, RH Door	7.4 lbs/box	\$57.60
L78L-LCA	LH	26D, US3	1-1/8"	n/a	Less cylinder, LH Door	7.0 lbs/box	\$56.30
L78L-LCM	LH	26D, US3	1-3/8"	n/a	Less cylinder, LH Door	7.4 lbs/box	\$57.60

L78-KNOB	26D, US3	Emergency inside-release knob					\$1.87
----------	----------	-------------------------------	--	--	--	--	--------

Emergency release knob allows latch to be retracted from inside of door.

VERTICAL-HAND (VH) = Drawer with bolt locking up
INVERTED-HAND (IH) = Drawer with bolt locking down

RIGHT-HAND (RH) = Door hinged on right
LEFT-HAND (LH) = Door hinged on left



CABINET LOCKS FOR SARGENT CYLINDERS

General Information

Compatibility: Accepts Sargent original cylinder #13-3457

Finishes: For finishes not listed, see charges under "custom finishes" in this price list or consult factory.

Accessories: Additional accessories are available for these products.

See accessories section or consult factory.

For Sargent original cylinder #13-3457

754LC • Door Deadbolt

Packed 10/Box



Part #	Finish	Fits Mat.	Pinning	Description	Weight	Price Each
754LC	26D, US3	1-3/8"	n/a	Less cylinder	5.8 lbs/box	\$44.00

854LC • Drawer Deadbolt

Packed 10/Box



Part #	Finish	Fits Mat.	Pinning	Description	Weight	Price Each
854LC	26D, US3	1-3/8"	n/a	Less cylinder	5.8 lbs/box	\$44.00



CABINET LOCKS FOR MEDECO/YALE/ASSA IC CORE

General Information

Medeco Core: Accepts Medeco (6-pin) IC core cylinder #32-0201.
 Medeco core requires use of Medeco #94-0009 or Olympus 931-1M spacer. The 931DR/DW ships standard with Olympus 931-1M spacer.
 Yale Core: Accepts Yale 1210 Series (6-pin) IC core cylinder.
 ASSA Core: Accepts ASSA's Yale 6 pin compatible large format IC core.

Finishes: For finishes not listed, see charges under "custom finishes" in this price list or consult factory.
 Accessories: Additional accessories are available for these products. See the accessories section or consult factory.

931DR • Door Deadbolt



Part #	Finish	Fits Mat.	Description	Weight	Price Ea.
931DR	26D, US3	1-3/8"	IC Door Lock	6.5 lbs/box	\$55.00
931DR-KR	26D, US3	1-3/8"	IC Door Lock-key retaining	6.5 lbs/box	\$60.00
931-1M	Spacer for Medeco 6-pin IC core cylinders				\$10.30

*931DR and 931DR-KR locks ship standard with 931-M spacer.

931DW • Drawer Deadbolt



Part #	Finish	Fits Mat.	Description	Weight	Price Ea.
931DW	26D, US3	1-3/8"	IC Drawer Lock	6.5 lbs/box	\$55.00
931DW-KR	26D, US3	1-3/8"	IC Drawer Lock-key retaining	6.5 lbs/box	\$60.00
931-1M	Spacer for Medeco 6-pin IC core cylinders				\$10.30

*931DW and 931DW-KR locks ship standard with 931-M spacer.



PADLOCKABLE CAM LOCK

General Information

Function: Uses padlock as locking device.
 Compatibility: Accepts most standard padlocks with a shackle diameter of 3/8" (10 mm) or less.

Finishes: For finishes not listed, consult factory.
 Padlocks: See padlock section in this price list.

DCP • CAM LOCK

Packed 12/Box



Part #	Finish	Fits Material	Description	Weight	Price Ea.
DCP	US3, US26, US19	1-7/32"	Accepts most standard padlocks	4.5 lbs/box	\$15.40
Additional Cams				Each	\$1.50
DCP-SC*	Short straight cam		DCP-LBC.....	1-1/4" long cam with 1/4" offset	
DCP-LC*	1-1/4" long straight cam		DCP-118-18.....	1-1/8" long cam with 1/8" offset	
DCP-LC-112.....	1-1/2" long straight cam		DCP-LBC-138.....	1-3/8" long cam with 3/8" offset	
DCP-LC-134.....	1-3/4" long straight cam		DCP-LBC-178.....	1-7/8" long cam with 1/4" offset	

*DCP ships standard with DCNP-500-ARP anti-rotation plate, DCP-SC and DCP-LC cams.



CABINET LOCKS FOR SCHLAGE LARGE FORMAT IC CORE

General Information

Compatibility: Accepts Schlage-style large format IC cores
Schlage: Chambers both standard or Primus/Everest Schlage LFIC cores.

Mul-T-Lock: Chambers Mul-T-Lock large format IC cores.
Medeco: Chambers Medeco Keymark large format IC cores.

Cores: LFIC cores not included.

Finishes: For finishes not listed, see charges under "custom finishes" in this price list or consult factory.

Accessories: Additional accessories are available for these products. See accessories section or consult factory.

777 • Deadbolt Door

Packed 10/Box



Part #	Handing	Finish	Fits Mat.	Description	Weight	Price Each
777IC-DR	n/a	26D, US3	1-7/16"	Less cylinder	7.2 lbs/box	\$65.00

Key-Retaining Function (Schlage LFIC Classic Cores)

777IC-RHK	RH	26D, US3	1-7/16"	Less cylinder, key retaining	7.2 lbs/box	\$70.00
777IC-LHK	LH	26D, US3	1-7/16"	Less cylinder, key retaining	7.2 lbs/box	\$70.00

Key-Retaining Function (Schlage LFIC Primus or Everest Cores)

777P-RHK	RH	26D, US3	1-7/16"	Less cylinder, key retaining	7.2 lbs/box	\$70.00
777P-LHK	LH	26D, US3	1-7/16"	Less cylinder, key retaining	7.2 lbs/box	\$70.00

Add \$14.00 to above prices for US10B finish.

888 • Deadbolt Drawer

Packed 10/Box



Part #	Handing	Finish	Fits Mat.	Description	Weight	Price Each
888IC-DW	n/a	26D, US3	1-7/16"	Less cylinder	7.2 lbs/box	\$65.00

Key-Retaining Function (Schlage LFIC Classic Cores)

888IC-RHK	RH	26D, US3	1-7/16"	Less cylinder, key retaining	7.2 lbs/box	\$70.00
888IC-LHK	LH	26D, US3	1-7/16"	Less cylinder, key retaining	7.2 lbs/box	\$70.00

Key-Retaining Function (Schlage LFIC Primus or Everest Cores)

888P-RHK	RH	26D, US3	1-7/16"	Less cylinder, key retaining	7.2 lbs/box	\$70.00
888P-LHK	LH	26D, US3	1-7/16"	Less cylinder, key retaining	7.2 lbs/box	\$70.00

Add \$14.00 to above prices for US10B finish.

VERTICAL-HAND (VH) = Drawer with bolt locking up
INVERTED-HAND (IH) = Drawer with bolt locking down

RIGHT-HAND (RH) = Door hinged on right
LEFT-HAND (LH) = Door hinged on left

920 • Cam Lock

Packed 10/Box



Part #	Handing	Finish	Cyl. Length	Description	Weight	Price Each
920LM/DM	n/a	26D, US3	1-7/16"	Less cylinder	4.0 lbs/box	\$43.90
Additional Cams				*720-3-1, *720-3-2, 720-3-3, 720-3-4, 720-3-5		\$2.20
Trim Collars				TR201, TR202, TR203, TR200A		See page 21
SW-1				Switch accessory pack		\$8.45

*The 920LM/DM comes standard with 720-PL3 (anti-rotation plate), lost-motion and key retaining door/drawer drivers, and 720-3-1 and 720-3-2 cams. Additional cams available separately.



CABINET LOCKS FOR CORBIN/RUSSWIN IC CORE

General Information

Compatibility: Accepts Corbin/Russin 6 or 7 pin IC cores.

Cores: Corbin/Russwin cores not included.

Finishes: For finishes not listed, see charges under "custom finishes" in this price list or consult factory.

Accessories: Additional accessories are available for these products. See accessories section or consult factory.

CR1125RD • Door Deadbolt

Packed 10/Box



RH=Right-hand



LH=Left-hand

Part #	Handing	Finish	Fits Mat.	Description	Weight	Price Each
CR1125RD	RH	26D	1-1/8"	Rim deadbolt, right-hand door	4.8 lbs/box	\$49.00
CR1125RD	LH	26D	1-1/8"	Rim deadbolt, left-hand door	4.8 lbs/box	\$49.00
1125-1*				Spacer for 6-pin cores		\$1.18

* 1125-1 spacer ships standard with each CR1125 lock.

CR1125RD • Drawer Deadbolt

Packed 10/Box



Part #	Handing	Finish	Fits Mat.	Description	Weight	Price Each
CR1125RD	VH	26D	1-1/8"	Rim deadbolt, drawer vertical	4.8 lbs/box	\$49.00
1125-1 *				Spacer for 6-pin cores		\$1.18

* 1125-1 spacer ships standard with each CR1125 lock.

CR1125RL • Drawer Latch

Packed 10/Box



Part #	Handing	Finish	Fits Mat.	Description	Weight	Price Each
CR1125RL	VH	26D	1-1/8"	Rim latch, drawer vertical	4.8 lbs/box	\$49.00
1125-1 *				Spacer for 6-pin cores		\$1.18

* 1125-1 spacer ships standard with each CR1125 lock.

VERTICAL-HAND (VH) = Drawer with bolt locking up
INVERTED-HAND (IH) = Drawer with bolt locking down

RIGHT-HAND (RH) = Door hinged on right
LEFT-HAND (LH) = Door hinged on left



SMALL FORMAT IC CORES

General Information

Compatibility: Cores are available in 6- or 7-pin versions and are compatible with Best, Arrow, Falcon or other similar small format IC cores.

Keyways: Available in keyways listed below.
Finishes: Available in 26D or US4.

206/207 · Cores are Best, Arrow, Falcon Equivalent



Available Keyways

A	B	C	D	E	F	G	H	J
K	L	M	Q	1C	1D	KMT300		

Cores available in 6 or 7 pin versions

Part #	Description	Price Each
206-(x*)-(y*)	6 pin core, uncombined	\$22.00
206-(x*)-(y*)-CUST	6 pin core, KA, KD or MK	\$38.00
207-(x*)-(y*)	7 pin core, uncombined	\$23.20
207-(x*)-(y*)-CUST	7 pin core, KA, KD or MK	\$39.20

x* = Specify keyway: A,B,C,D,E,F,G,H,J,K,L,M,Q,1C,1D,KMT300

y* = Specify finish: 26D, US4

CUST: Specify type of keying required

Keyblanks & cut keys

Part #	Description	Price Each
KB-400K(x*)	Keyblank for 6 or 7 pin core	\$2.30
KB-400K(x*)-CUST	Cut key for 6 or 7 pin core	\$3.25

x* = Specify keyway: A,B,C,D,E,F,G,H,J,K,L,M,Q,1C,1D,KMT300



CABINET LOCKS FOR SMALL FORMAT IC CORE

General Information

Compatibility: Accepts Best, Arrow, Falcon or compatible 6 or 7 pin small format IC cores.

Cores: Cores not included with locks. Cores can be purchased separately. See page 17 of this price list.

Finishes: For finishes not listed, see charges under "custom finishes" in this price list or consult factory.

Accessories: Additional accessories are available for these products. See accessories section or consult factory.

720 • Cam Lock

Packed 10/Box



Part #	Finish	Cyl. Length	Description	Weight	Price Each
720LM/DM	26D, US26, US3, US4	1-7/16"	IC Cam Lock	4.0 lbs/box	\$39.00
Additional Cams	*720-3-1, *720-3-2, 720-3-3, 720-3-4, 720-3-5				\$2.20
Trim Collars	TR201, TR202, TR203, TR200A				See page 21
SW-1	Switch accessory pack				\$8.45

*The 720 comes standard with 720-PL3 (anti-rotation plate), lost-motion and key retaining door/drawer drivers, and 720-3-1 and 720-3-2 cams. Additional cams available separately.

721 Series • Field Reversible Deadbolt Lock

Packed 10/Box



721DR
DOOR



721DW
DRAWER

Part #	Finish	Fits Mat.	Description	Weight	Price Each
721DR	26D, US26, US3	1-1/4"	IC Door Lock	6.0 lbs/box	\$45.00
721DR-KR	26D, US26, US3	1-1/4"	IC Door Lock, key retaining	6.0 lbs/box	\$50.00
721DW	26D, US26, US3	1-1/4"	IC Drawer Lock	6.0 lbs/box	\$45.00
721DW-KR	26D, US26, US3	1-1/4"	IC Drawer Lock, key retaining	6.0 lbs/box	\$50.00

Add \$15.00 to above prices for US10B finish.

Includes all parts standard in the package to reverse from drawer to door/drawer to door and to convert to key-retaining function. Key retaining function can be ordered pre-configured from the factory at the above price.

VERTICAL-HAND (VH) = Drawer with bolt locking up
INVERTED-HAND (IH) = Drawer with bolt locking down

RIGHT-HAND (RH) = Door hinged on right
LEFT-HAND (LH) = Door hinged on left

722 • Sliding Door Push Lock

Packed Each



Part #	Finish	Fits Material	Description	Weight	Price Each
722S	26D, US26	3/4" - 1-1/2"	IC Push Lock	0.5 lbs/ea.	\$73.00
722S-KR	26D	3/4" - 1-1/2"	IC Push Lock, key retaining*	0.5 lbs/ea.	\$80.00
722S-TBM	26D, US26	3/4" - 1-1/2"	IC Push Lock, through-bolt mount	0.5 lbs/ea.	\$89.00
722S-TBM-KR	26D	3/4" - 1-1/2"	IC Push Lock, through-bolt mount, key retaining*	0.5 lbs/ea.	\$96.00

*Key retaining function - key removable in locked position only.

723 • Sliding Door Cylinder Housing

Packed Each



Part #	Finish	Fits Material	Description	Weight	Price Each
723S	26D, US26	Adjustable	Sliding door cylinder housing	0.1 lbs/ea.	\$42.00



CABINET LOCKS FOR SMALL FORMAT IC CORE

725ML • Mortise Mount Latch Locks

Packed 10/Box



725ML
IH DRAWER

Part #	Finish	*Fits Mat.	Description	Weight	Price Each
725ML-DR-RH	26D, US26, US3, US4	1-1/16" - 1-1/2"	RH Door	5.1 lbs/box	\$42.80
725ML-DR-LH	26D, US26, US3, US4	1-1/16" - 1-1/2"	LH Door	5.1 lbs/box	\$42.80
725ML-DW-VH	26D, US26, US3, US4	1-1/16" - 1-1/2"	VH Drawer	5.1 lbs/box	\$42.80
725ML-DW-IH	26D, US26, US3, US4	1-1/16" - 1-1/2"	IH Drawer	5.1 lbs/box	\$42.80
725ML-DWRVH	26D, US26, US3, US4	1-1/16" - 1-1/2"	VH Drawer (reverse latch)	5.1 lbs/box	\$42.80
725ML-DWRIH	26D, US26, US3, US4	1-1/16" - 1-1/2"	IH Drawer (reverse latch)	5.1 lbs/box	\$42.80

*Material thickness: Will fit up to 1-1/2" material thickness when mortised into the door or drawer material.

725MD • Mortise Mount Deadbolt Locks

Packed 10/Box



725MD
RH DOOR

Part #	Finish	*Fits Mat.	Description	Weight	Price Each
725MD-DR-RH	26D, US26, US3, US4	1-1/16" - 1-1/2"	RH Door	5.0 lbs/box	\$42.80
725MD-DR-LH	26D, US26, US3, US4	1-1/16" - 1-1/2"	LH Door	5.0 lbs/box	\$42.80
725MD-DW-VH	26D, US26, US3, US4	1-1/16" - 1-1/2"	VH Drawer	5.0 lbs/box	\$42.80
725MD-DW-IH	26D, US26, US3, US4	1-1/16" - 1-1/2"	IH Drawer	5.0 lbs/box	\$42.80
725MD-DWKVH	26D, US26, US3, US4	1-1/16" - 1-1/2"	VH Drawer (key retaining)	5.0 lbs/box	\$42.80

*Material thickness: Will fit up to 1-1/2" material thickness when mortised into the door or drawer material.

725RL • Rim (Surface) Mount Latch Locks

Packed 10/Box



725RL
VH DRAWER

Part #	Finish	Fits Mat.	Description	Weight	Price Each
725RL-DR-RH	26D, US26, US3, US4	1-1/16"	RH Door	5.3 lbs/box	\$42.80
725RL-DR-LH	26D, US26, US3, US4	1-1/16"	LH Door	5.3 lbs/box	\$42.80
725RL-DW-VH	26D, US26, US3, US4	1-1/16"	VH Drawer	5.3 lbs/box	\$42.80
725RL-DW-IH	26D, US26, US3, US4	1-1/16"	IH Drawer	5.3 lbs/box	\$42.80
725RL-DWRVH	26D, US26, US3, US4	1-1/16"	VH Drawer (reverse latch)	5.3 lbs/box	\$42.80
725RL-DWRIH	26D, US26, US3, US4	1-1/16"	IH Drawer (reverse latch)	5.3 lbs/box	\$42.80

725RD • Rim (Surface) Mount Deadbolt Locks

Packed 10/Box



725RD
LH DOOR

Part #	Finish	Fits Mat.	Description	Weight	Price Each
725RD-DR-RH	26D, US26, US3, US4	1-1/16"	RH Door	5.0 lbs/box	\$42.80
725RD-DR-LH	26D, US26, US3, US4	1-1/16"	LH Door	5.0 lbs/box	\$42.80
725RD-DW-VH	26D, US26, US3, US4	1-1/16"	VH Drawer	5.0 lbs/box	\$42.80
725RD-DW-IH	26D, US26, US3, US4	1-1/16"	IH Drawer	5.0 lbs/box	\$42.80
725RD-DWKVH	26D, US26, US3, US4	1-1/16"	VH Drawer (key retaining)	5.0 lbs/box	\$42.80

VERTICAL-HAND (VH) = Drawer with bolt locking up
INVERTED-HAND (IH) = Drawer with bolt locking down

RIGHT-HAND (RH) = Door hinged on right
LEFT-HAND (LH) = Door hinged on left

728 • Mailbox Lock

Packed 10/Box



Part #	Finish	Fits Material	Description	Weight	Price Each
728MBL	26D	Adjustable	IC Mail Box Lock	2.2 lbs/box	\$34.00



CABINET LOCKS FOR SMALL FORMAT IC CORE

729R • Sliding Door Ratchet Lock

Packed 10/Box



Part #	Finish	Size	Description	Weight	Price Each
729R*	26D	For 1/4" panels	Ratchet Lock	6.5 lbs/box	\$53.00

*729R ships standard with 729RS-1 strap for 1/4" panel thickness.

729RS-2	Optional strap for 3/8" panel thickness			Each	\$7.26
729RS-3	Adjustable strap for maximum 5/8", minimum 3/8" panel thickness			Each	\$11.00

950 • Deadlatching Drawer Lock

Packed 10/Box



Part #	Finish	Fits Material	Description	Weight	Price Each
950IC	26D, US3	1-1/8"	IC Deadlatching Drawer	7.1 lbs/box	\$52.40



CABINET LOCK DRILL GUIDE

CL-HIT-25 • Cabinet Lock Drill Guide

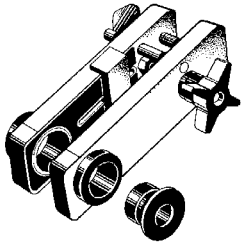

Part #	Description	Price Each
CL-HIT-25	Cabinet Lock Drilling Guide	\$230.00

Includes four sizes of drill bushings: 3/4", 7/8", 1-1/8" and 1-1/4". For use with Forstner-type drill bits. Not compatible with hole saws, paddle or spade type bits.



SPACERS & TRIM



TR1256 / TR78
Trim Rings



WP21
Spacers



WP22
Spacers



WP23
Spacers



ETS1-PL
Cabinet Pull



ETS2-PL
Cabinet Pull



ETS1 / ETST
Reinforcing Trim Spacers / Templates



10-350
Spacers



TR202
Trim Collar

For Small Pin Cabinet Locks (7/8" barrel diameter)

Packed Each

Part #	Finish	Description	Price Each
TR1256	26D, US4	Trim ring for 7/8" diameter cabinet locks	\$2.64
WP21	White Plastic	3/32" thick spacer for use with 100, 200, 500, 600, N078, R078	\$1.21
WP22	White Plastic	1/4" thick spacer for use with 100, 200, 500, 600, N078, R078	\$1.27
WP23	White Plastic	1/2" thick spacer for use with 100, 200, 500, 600, N078, R078	\$1.33
ETS2-PL	26D, US3	Cabinet pull for use with ETST2 series trim spacers/templates	\$7.26
ETS2-125	26D, US3	1/8" thick reinforcing trim spacer for 100, 200, 500, 600	\$6.71
ETS2-250	26D, US3	1/4" thick reinforcing trim spacer for 100, 200, 500, 600	\$6.71
ETST2	26D, US3	Template for ETS2 series reinforcing trim spacers	\$2.75
ETS3	26D, US3	Reinforcing trim spacer for N078, R078	\$6.71
ETST3	26D, US3	Template for ETS3 reinforcing trim spacer	\$2.75
ETS6	26D, US3	Reinforcing trim spacer for 999, 998, 997, 996	\$6.71
ETST6	26D, US3	Template for ETS6 and ETS2-PL reinforcing trim spacers & pulls	\$2.75

For Large Pin Cabinet Locks (1-1/8" barrel diameter)

Packed Each

Part #	Finish	Description	Price Each
TR78	26D, US3	Trim ring for 1-1/8" diameter cabinet locks: 700,721,754,777,800,850,854,888,950,L7080	\$2.86
10-348	White Plastic	1/4" thick spacer for 700,721,754,777,800,850,854,888,950	\$1.71
10-349	White Plastic	1/2" thick spacer for 700,721,754,777,800,850,854,888,950	\$1.77
10-350	White Plastic	1/8" thick spacer for 700,721,754,777,800,850,854,888,950	\$1.65
10-351	White Plastic	1/8" thick spacer for L7080	\$1.65
ETS1-PL	26D, US3	Cabinet pull for use with ETS1/ETST1 series trim spacers/templates	\$7.26
ETS1-125	26D, US3	1/8" thick reinforcing trim spacer for 700,721,754,777,800,850,854,888,950	\$6.71
ETS1-250	26D, US3	1/4" thick reinforcing trim spacer for 700,721,754,777,800,850,854,888,950	\$6.71
ETS1B	26D, US3	Blank reinforcing trim spacer (no center hole)	\$6.71
ETST1	26D, US3	Template for ETS1/ETS1B/ETS4/ETS5 series reinforcing trim spacers	\$2.75
ETS4	26D, US3	Reinforcing Trim Spacer for 777	\$8.03
ETS5	26D, US3	Reinforcing Trim Spacer for 888	\$8.03

For 720, 820, 920 Cam Locks

Packed Each

Part #	Finish	Description	Price Each
TR201	32D, US3	1/8" trim collar	\$3.08
TR202	32D, US3	1/4" trim collar	\$3.52
TR203	32D, US3	3/8" trim collar	\$3.96
TR200A	32D, US3	Trim collar package (includes above three trim collars)	\$10.56

WP21, WP22, WP23, 10-348, 10-349, 10-350, & 10-351 interior spacers: These spacers are used for flush fitting locks on various material thicknesses. They are intended for use on the interior of the cabinet door or drawer and can be stacked to create the desired thickness.

TR1256, TR78 trim rings: Provides ability to cover up unevenly drilled holes or other flaws around the hole site.

TR201, TR202, TR203, TR200A trim collars: Provide forward spacing to bring lock face forward on thin material thicknesses.

ETS/ETST Series reinforcing spacers and templates: The ETS and ETST series reinforcing trim spacers and templates are made of diecast material and plated in either US26D or US3 finish. The reinforcing trim spacers are intended for use on the exterior of the cabinet door or drawer and provide through-bolt mounting of cabinet locks for a more secure application. The ETST series templates are 1/8" thick and can be used either behind the ETS trim spacer on the front of the cabinet or between the cabinet lock body and the cabinet material on the inside of the cabinet door or drawer. The ETS-PL Series fits between the cabinet face and the reinforcing trim spacer and serves as a cabinet pull in either door or drawer applications.



CABINET LOCK STRIKES

For Small Pin Cabinet Locks (7/8" barrel diameter)

Packed Each

Part #	Finish	Description	Price Each
12-1	26D, US4	Small angle strike	\$1.55
12-2	26D	Large angle strike	\$1.65
56-1	26D, US4	Bar strike	\$1.55
07S	26D, US4	Slotted strike	\$1.60
999-STRIKE	US3	Lipped strike	\$1.87
2SPD-SP	26D, US3	Lock cover (see page 24)	\$3.08
2SPD-KEPR	26D, US3	Strike box (see page 24)	\$4.73



12-1
Angle Strike



56-1
Bar Strike



07S
Slotted Strike



12-2
Angle Strike



999-STRIKE
Lipped Strike

For Large Pin/IC Core Cabinet Locks (1-1/8" barrel diameter)

Packed Each

Part #	Finish	Description	Price Each
10-052	26D	Slotted strike (strike only)	\$1.83
10-054	White Plastic	1/4" bar strike (strike only)	\$1.83
10-055	White Plastic	1/2" bar strike (strike only)	\$1.83
10-352	26D	Screw pack: includes 10-052 slotted strike with screws	\$2.03
10-354	White Plastic	Screw pack: includes 10-054 1/4" bar strike with screws	\$2.03
10-355	White Plastic	Screw pack: includes 10-055 1/2" bar strike with screws	\$2.03
10-056	26D	Notched strike	\$1.83
850-210	26D, US4	Lipped strike for 850/950 (1-1/8" barrel length)	\$4.80
850-211	26D, US4	Lipped strike for 850 (1-3/8" barrel length)	\$4.80
L78ST-1	US3	Lipped strike for L7080 (1-1/8" barrel length)	\$2.34
L78ST-2	US3	Lipped strike for L7080 (1-3/8" barrel length)	\$2.34
2LPD-SP	26D, US3	Lock cover (see page 24)	\$3.08
2LPD-KEPR	26D, US3	Strike box (see page 24)	\$4.73



10-052
Slotted Strike



10-054
Bar Strike



10-055
Bar Strike



10-056
Notched Strike



L78ST-1 / L78ST-2
Lipped Strike

For 725/CR1125 Series IC Core Cabinet Locks

Packed Each

Part #	Finish	Description	Use With	Price Each
725-SP-MD	US3	Screw pack: Slotted strike with screws	Mortise Deadbolt	\$2.58
725-SP-ML	US3	Screw pack: Slotted lip strike with screws	Mortise Latch	\$2.58
725-SP-RD	US3	Screw pack: Flat strike with screws	Rim Deadbolt	\$2.58
725-SP-RL	US3	Screw pack: Flat lipped strike with screws	Rim Latch	\$2.58



725-SP-MD



725-SP-RD



725-SP-ML



725-SP-RL



PINS & N1, R1 PIN KITS

PIN KITS & PINS · For Olympus Small Pin Cabinet Locks (7/8" barrel diameter)



Made in USA

Part #	Description	Price Each
N1	N1 Keying Kit For Olympus or National D4291 keyway (includes metal box) Includes: 100 ea. Drivers 1-4, 100 ea. Master drivers 2-9, 100 ea. Tumblers 0-9, 100 ea. Tumbler springs, 10 ea. Set screws, 1 ea. Plug follower	\$170.00
R1	R1 Keying Kit For Olympus or CCL R1 keyway (includes metal box) Includes: 100 ea. Master pins 2-9, 100 ea. Bottom pins 0-9, 100 ea. Drivers 0 & 5, 100 ea. Tumbler springs, 10 ea. Set screws, 1 ea. Plug follower	\$170.00
Extra pins for key kits	Specify keyway and pins required (bags of 100)	\$10.00 bag



DISPLAY BOARDS

FDB · Olympus Free-Standing Display Boards



FDB-001



FDB-002



FDB-003



FDB-004

Part #	Description	Price Each
FDB-001	Includes sampling of handles, large pin, small pin and IC core locks	\$260.00
FDB-002	Includes sampling of our small pin locks	\$230.00
FDB-003	Includes sampling of our large pin locks	\$230.00
FDB-004	Includes sampling of our interchangeable core locks	\$230.00



OLYMPUS 2000 HANDLES



Use optional wire pull for ADA compliance

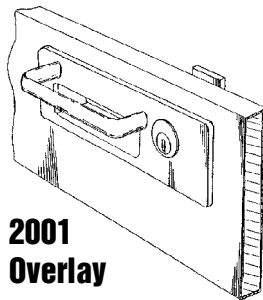

**2001
Overlay**

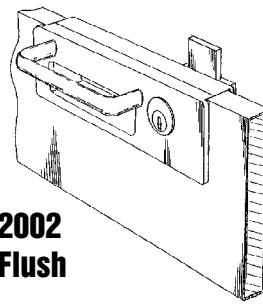

**2002
Flush**

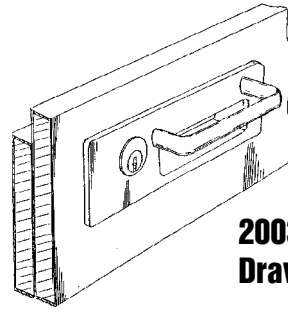

**2003/2004
Drawer**

Small Format Handles

Small format handles accept the following Olympus cabinet locks: 100DR, 200DW, 500DR, 600DW. With 2000MED cam lock adapter: DCN / DCR Series or Medeco 3/4" cam locks. Handles do not include oval wire pull. If required, please order as a separate item

Large Format Handles

Large format handles accept the following Olympus cabinet locks: 700 (1-3/8"), 800 (1-3/8"), 721, 754, 777, 854, 888, 931. Handles do not include oval wire pull. If required, please order as a separate item

Optional Handle Accessories

FOR SMALL FORMAT HANDLES



Oval Wire Pull

Part #	Finish	Description	Price Each
337-3-1/2SC	26D	3-1/2" satin chrome oval wire pull (old style)	\$4.40
337-3-1/2	US3	3-1/2" polished brass oval wire pull (old style)	\$4.40
102-015-96SC	26D	3-3/4" oval wire pull, 26D satin chrome	\$5.00
102-015-96	US3	3-3/4" oval wire pull, US3 polished brass	\$5.00
102-015-96-10B	10B	3-3/4" oval wire pull, US10B	\$9.80
102-015-4SC	26D	4" satin chrome oval wire pull	\$5.00
102-015-4	US3	4" polished brass oval wire pull	\$5.00
2000MED-DR	Door	Cam lock adapter for 3/4" cam locks (doors)	\$4.00
2000MED-DW	Drawer	Cam lock adapter for 3/4" cam locks (drawers)	\$4.00
2SPD-SP	26D, US3	Lock cover	\$3.08
2SPD-KEPR	26D, US3	Strike box	\$4.73

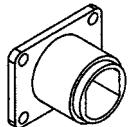

2000MED-DR

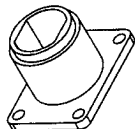

2000MED-DW

FOR LARGE FORMAT HANDLES

Part #	Finish	Description	Price Each
102-015-96SC	26D	3-3/4" satin chrome oval wire pull	\$5.00
102-015-96	US3	3-3/4" polished brass oval wire pull	\$5.00
102-015-96-10B	10B	3-3/4" oval wire pull, US10B	\$9.80
102-015-4SC	26D	4" satin chrome oval wire pull	\$5.00
102-015-4	US3	4" polished brass oval wire pull	\$5.00
2LPD-SP	26D, US3	Lock cover	\$3.08
2LPD-KEPR	26D, US3	Strike box	\$4.73



Lock cover



Strike box



OLYMPUS 2000 SMALL FORMAT HANDLES



Use optional wire pull for ADA compliance

2001SP - Overlay Construction

Packed 10/Box

Part #	Finish	Handing	Description	Weight	Price Each
2001SP-RH	26D, US3	Right hand	Overlay handle, RH, 26D	1.2 lbs/ea.	\$47.95
2001SP-LH	26D, US3	Left hand	Overlay handle, LH, 26D	1.2 lbs/ea.	\$47.95
2001SPD-RH	26D, US3	Right hand	Overlay dummy handle, RH, 26D	1.2 lbs/ea.	\$47.95
2001SPD-LH	26D, US3	Left hand	Overlay dummy handle, LH, 26D	1.2 lbs/ea.	\$47.95

2002SP - Flush Construction

Packed 10/Box

Part #	Finish	Handing	Description	Weight	Price Each
2002SP-RH	26D, US3	Right hand	Flush handle, RH, 26D	1.6 lbs/ea.	\$47.95
2002SP-LH	26D, US3	Left hand	Flush handle, LH, 26D	1.6 lbs/ea.	\$47.95
2002SPD-RH	26D, US3	Right hand	Flush dummy handle, RH, 26D	1.6 lbs/ea.	\$47.95
2002SPD-LH	26D, US3	Left hand	Flush dummy handle, LH, 26D	1.6 lbs/ea.	\$47.95

2003SP/2004SP - 1-1/4" to 1-1/2" Drawer Construction

Packed 10/Box

Part #	Finish	Handing	Description	Weight	Price Each
2003SP-RH	26D, US3	Right hand	Overlay handle for 1-1/2" material	1.6 lbs/ea.	\$47.95
2004SP-RH	26D, US3	Right hand	Overlay handle for 1-1/4" to 1-3/8" material	1.6 lbs/ea.	\$47.95
2003SPD-RH	26D, US3	Right hand	Overlay dmy handle for 1-1/2"	1.6 lbs/ea.	\$47.95
2004SPD-RH	26D, US3	Right hand	Overlay dmy handle for 1-1/4" to 1-3/8" mat.	1.6 lbs/ea.	\$47.95



OLYMPUS 2000 LARGE FORMAT HANDLES

2001LP - Overlay Construction

Packed 10/Box

Part #	Finish	Handing	Description	Weight	Price Each
2001LP-RH	26D, US3	Right hand	For 3/4" to 1" material	1.7 lbs/ea.	\$47.95
2001LP-LH	26D, US3	Left hand	For 3/4" to 1" material	1.7 lbs/ea.	\$47.95
2001LPD-RH	26D, US3	Right hand	Dummy handle, for 3/4" to 1" material	1.7 lbs/ea.	\$47.95
2001LPD-LH	26D, US3	Left hand	Dummy handle, for 3/4" to 1" material	1.7 lbs/ea.	\$47.95

2002LP - Flush Construction

Packed 10/Box

Part #	Finish	Handing	Description	Weight	Price Each
2002LP-RH	26D, US3	Right hand	For 3/4" to 7/8" material	1.9 lbs/ea.	\$47.95
2002LP-LH	26D, US3	Left hand	For 3/4" to 7/8" material	1.9 lbs/ea.	\$47.95
2002LPD-RH	26D, US3	Right hand	Dummy handle for 3/4" to 7/8" material	1.9 lbs/ea.	\$47.95
2002LPD-LH	26D, US3	Left hand	Dummy handle for 3/4" to 7/8" material	1.9 lbs/ea.	\$47.95

2003LP - 1-3/8" Drawer Construction

Packed 10/Box

Part #	Finish	Handing	Description	Weight	Price Each
2003LP-RH	26D, US3	Right hand	For 1-3/8" material	1.9 lbs/ea.	\$47.95
2003LPD-RH	26D, US3	Right hand	Dummy handle for 1-3/8" material	1.9 lbs/ea.	\$47.95

VERTICAL-HAND (VH) = Drawer with bolt locking up
INVERTED-HAND (IH) = Drawer with bolt locking down

RIGHT-HAND (RH) = Door hinged on right
LEFT-HAND (LH) = Door hinged on left



KEYING CHARGES, KEYS & CUSTOM FINISHES

KEYING CHARGES

Keying	Price Each
Grand master keying: add \$2.00 to the "custom, non-stock or masterkeyed" list price	\$2.00
Additional cut keys/master keys National or CCL Keyways	\$2.80
Additional cut keys/master keys Schlage "C" Keyway	\$3.25
Additional cut keys/master keys/control keys (SFIC Cores)	\$3.25
Special stamping—cabinet locks or keys only	\$2.00

KEY BLANKS

Part #	Description	Price Each
KBN-4-NP	National 4 pin keyblank (D4291)	\$1.20
KBN-5-NP	National 5 pin keyblank (D4292)	\$1.20
KBR-5-NP	CCL R1 5 pin keyblank (R1)	\$1.20
KBR-6-NP	CCL R1 6 pin keyblank (R1)	\$1.20
KBSC-5	Schlage "C" 5 pin keyblank	\$1.25
KBSC-6	Schlage "C" 6 pin keyblank	\$1.25
KB-400K(x*)	SFIC 6 or 7 pin keyblank - (x* = see page 20 for available keyways)	\$2.30

CUT KEYS

NATIONAL KEYWAY

Part #	For National Keyway Locks	Price Each
KB-101-NP	Cut key for KA #101	\$2.80
KB-103-NP	Cut key for KA #103	\$2.80
KB-107-NP	Cut key for KA #107	\$2.80
KB-915-NP	Cut key for KA #915	\$2.80
KBN-4-CUST	Custom cut 4-pin key	\$2.80
KBN-5-CUST	Custom cut 5-pin key	\$2.80
KB-GM1MK-NP	Cut National GM1 (4-pin) master key	\$2.80
KB-GM2MK-NP	Cut National GM2 (5-pin) master key	\$2.80

SFIC CORES

Part #	For Small Format IC Cores	Price Each
KB-400K(x*)-CUST	Cut key for 6 or 7 pin core	\$3.25

x* = Specify keyway: A,B,C,D,E,F,G,H,J,K,L,M,Q,1C,1D,KMT300

CCL KEYWAY

Part #	For CCL Keyway Locks	Price Each
KB-4T2-NP	Cut key for KA #4T21579	\$2.80
KB-4T3-NP	Cut key for KA #4T37526	\$2.80
KBR-5-CUST	Custom cut 5-pin key	\$2.80
KBR-6-CUST	Custom cut 6-pin key	\$2.80
KB-R1MK-NP	Cut CCL R1 (5 pin) master key	\$2.80

SCHLAGE C KEYWAY

Part #	For Schlage C Keyway Locks	Price Each
KB-700-101	Cut key for KA#101	\$3.25
KB-700-102	Cut key for KA#102	\$3.25
KB-700-CUST	Custom cut key Schlage C keyway	\$3.25
KB-700MK	Cut Schlage C (5-pin) master key	\$3.25

CUSTOM PLATING

Special Finish / Custom Plated List Prices	List Price Upcharge
Custom or special finishes: To calculate the "Price Each" for custom plated locks, add the amount in the right-hand column to the "custom, non-stock, or custom keyed" price of the product.	
Lock 100, 200, 300, 400, 500, 600, 999, 998, 997, 996	Add \$43.00
Lock 700, 800, 820, 754, 854, 850, 950, L7080, N078, R078, DCN, DCR	Add \$34.00
Lock 720, 721, 725, 728, CR1125, 777, 820, 888, 920, 729R	Add \$29.00



ADDITIONAL PARTS & ACCESSORIES, FINISH CHART

Part #	Description	Price Each
MISCELLANEOUS ACCESSORIES		
1256-3	Cylinder washer, 100/200/500/600	\$0.66
1256-4-78	Pin cover, 100/200/500/600, 7/8"	\$0.66
1256-4-138	Pin cover, 100/200/500/600, 1-3/8"	\$0.66
07834C-1	Pin cover for 300/400/N078/R078	\$0.66
ACCESSORIES FOR 300/400 SLIDING DOOR LOCKS		
S160	Stop screw	\$0.70
07834C-1	Pin cover	\$0.66
34-9	Strike bushing	\$1.32
S170	Bolt extender	\$1.65
ACCESSORIES FOR DCN/DCR CAM LOCKS		
DCNP-SL	Pin cover	\$0.66
CNCR-1	Retaining clip	\$0.70
DCNP-100-SC	Straight cam	\$1.50
DCNP-100-BC	Bent cam	\$1.50
DCNP-100-BC5	Bent cam, 1/2" offset	\$1.50
DCNP-100-LC	3" long straight cam	\$1.50
DCNP-100-LBC	Long bent cam	\$1.50
DCNP-100-WB	Short cam	\$1.50
DNCP-200- OCD	Outer cam driver	\$1.43
DNCP-200-RCS	Reverse cam stop	\$1.43
DCNP-300-FP	Finger pull, stainless steel	\$1.87
S200	Machine screw	\$0.70
CNCR-6	Screw washer	\$0.70
DCNP-600-NUT	Brass fixing nut	\$3.52
DCNP-200-KR	Key retaining driver-drawer	\$1.43
DCNP-200-KDR	Key retaining driver-door	\$1.43
DCNP-500-ARP	Anti rotation plate	\$1.66
ACCESSORIES FOR 700 & 800		
10-361	700/800 driver bar for 7/8"	\$1.18
10-362	700/800 driver bar for 1-3/8"	\$1.18
10-363	700/800 driver bar, Medeco	\$1.18
10-364	700/800 driver bar, Assa	\$1.18
10-360	Universal driver	\$0.94
10-112	700 bolt driver, Assa	\$4.73
10-212	800 bolt driver, Assa	\$4.73
S190	Set screw	\$0.70
720 CAM LOCK		
725-PA	Plastic actuator	\$2.11
725-1	Internal spacer	\$1.18
720-PD	Prong driver	\$3.52

Part #	Description	Price Each
720, 820, 920 CAM LOCKS		
720-CDLM	Cam driver, lazy motion	\$1.43
720-CDDM	Cam driver, direct motion	\$1.43
720-KR	Cam driver, key-retain door	\$1.43
720-3-1	Short cam, 7/8"	\$2.20
720-3-2	Long vertical cam, 1-3/4"	\$2.20
720-3-3	Long inverted cam, 1-3/4"	\$2.20
720-3-4	Long straight cam, 3"	\$2.20
720-3-5	Long inverted bent cam	\$2.20
720-4	Brass fixing nut	\$3.52
CNCR-6	Screw washer	\$0.70
S200	Machine screw	\$0.70
S260	Threaded cam stop pin	\$0.70
720-PL3	Stabilizer plate	\$1.76
721 CABINET LOCK		
725-PA	Plastic actuator	\$2.11
721-1	Bolt for 721	\$4.73
721-2	Bolt driver	\$2.37
721DR-11	Prong driver	\$4.73
721DW-11	Prong driver	\$4.73
S190	Set screw	\$0.70
725 CABINET LOCK		
725-PA	Plastic actuator	\$2.11
725-1	Internal spacer	\$1.18
CR1125		
725-PA	Plastic actuator	\$2.11
1125-1	6 pin core spacer	\$1.18
777 & 888		
7788-PA-13	Plastic actuator, for key retaining	\$2.11
7788-PA-24	Plastic actuator, for key retaining	\$2.11
7788-PA-D	Plastic actuator, for standard function	\$2.11
920LM/DM		
7788-PA-D	Plastic actuator	\$2.11

Other parts may be available. Call Olympus for price and availability.

FINISH CHART

Standard finishes:

Not all finishes available on all products. See catalog or price page for the standard finishes available for a specific item.

Finish	Description
US26 625	Bright chrome
US26D 626	Dull chrome
US3 605	Bright brass
US4 606	Satin brass
US32D 630	Satin stainless steel

Special order finishes:

Other special order finishes not listed below may be available. See above Custom Plating for prices. Call Olympus Lock for lead time and availability.

Finish	Description
US10B 613	Oil rubbed bronze
US19 622	Flat black coated



BRASS PADLOCKS

GENERAL FEATURES • Brass Padlocks

Olympus Series	Mountain Series	Rekeyable	I.C. Core
Pin tumbler Solid brass body Hardened steel shackle Brass internal parts Heel & toe locking KD and KA All weather indoor/outdoor Includes 3 keys per lock Box packed	Pin tumbler Solid brass body Hardened steel shackle Brass internal parts Heel & toe locking KD and KA All weather indoor/outdoor Includes 3 keys per lock Blister packed	Extruded brass Body width: 1 3/4" (45mm) Hardened steel shackle with retaining pin Double locking heel & toe "O" bitted standard Includes 2 keyblanks per lock Pin tumbler (six pin capability) Box packed	Extruded brass Body width: 2" (50mm) Stainless steel shackle Ball bearing locking heel & toe BHMA 606 (US4) satin brass finish Chambers Corbin/Russwin 6-pin I.C. cylinders Core not included Box packed

Special note on our keyed different padlocks:

Olympus does not guarantee that for any group of keyed different padlocks there will not be some locks that may be opened by the same key. The larger the group of keyed different padlocks, the higher the likelihood that some locks may be operated by the same key.

MOUNTAIN SERIES

Part #	A	Keying	B	C	D	Box Qty	Weight
BP075	3/4"	KD or KA #30	1/2"	1/2"	5/32"	10	1.1 lbs.
BP100	1"	KD or KA #40 & #45	1/2"	1/2"	5/32"	10	1.1 lbs.
BP125	1-1/4"	KD or KA #51	5/8"	5/8"	7/32"	10	2.1 lbs.
BP125-LS	1-1/4"	KD or KA #51 & #59	2-1/8"	5/8"	7/32"	10	3.1 lbs.
BP150	1-1/2"	KD or KA #60, #61 & #65	7/8"	3/4"	1/4"	10	3.9 lbs.
BP150-LS	1-1/2"	KD or KA #60 & #65	2-1/2"	3/4"	1/4"	10	4.7 lbs.
BP175	1-3/4"	KD or KA #70 & #75	1"	1"	9/32"	5	2.9 lbs.
BP200	2"	KD or KA #80	1-1/8"	1"	11/32"	5	3.1 lbs.

Note: All fractional measurements are approximate.

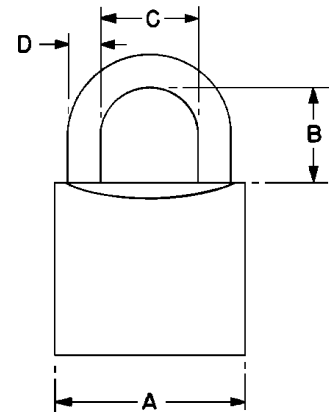

OLYMPUS SERIES

Part #	A	Keying	B	C	D	Box Qty	Weight
B075	3/4"	KD or KA #5 & #25	3/8"	3/8"	1/8"	12	1.0 lbs.
B100	1"	KD or KA #10	1/2"	1/2"	5/32"	6	1.0 lbs.
B125	1-1/4"	KD or KA #1 & #3	5/8"	5/8"	7/32"	6	1.5 lbs.
B125-LS	1-1/4"	KD or KA #1	2-1/2"	5/8"	7/32"	6	1.7 lbs.
B150	1-1/2"	KD or KA #2, #4, #9	3/4"	3/4"	1/4"	6	2.2 lbs.
B150-LS	1-1/2"	KD or KA #2 & #4	2-3/4"	3/4"	1/4"	6	2.7 lbs.
B200	2"	KD or KA #14 & #15	1"	1"	11/32"	6	4.2 lbs.
B250	2-1/2"	KD or KA #6, #7 & #8	1-1/4"	1-1/4"	7/16"	6	7.5 lbs.

Note: All fractional measurements are approximate.

A = Body size

B = Distance between top of lock and inside shackle

C = Width of inside shackle

D = Shackle diameter



BRASS PADLOCKS

OLYMPUS SERIES · BOX PACKED BRASS PADLOCKS



Part #	Width	Keying	Shackle	*Box Qty.	Case Qty.	Price Each
B075	3/4"	KD, KA 5	Regular	12	600	\$3.15
B100	1"	KD, KA 10	Regular	6	360	\$3.54
B125	1-1/4"	KD, KA 1,3	Regular	6	240	\$4.91
B125LS	1-1/4"	KD, KA 1	Long	6	120	\$5.19
B150	1-1/2"	KD, KA 2,4,9,11,12	Regular	6	120	\$5.62
B150LS	1-1/2"	KD, KA 2,4	Long	6	120	\$5.92
B200	2"	KD, KA 14,15	Regular	6	60	\$11.55
B250	2-1/2"	KD, KA 6,7,8	Regular	6	48	\$18.70

***Sold in box quantities only.**

MOUNTAIN SERIES · BLISTER PACKED BRASS PADLOCKS



Part #	Width	Keying	Shackle	*Box Qty.	Case Qty.	Price Each
BP075	3/4"	KD, KA 30	Regular	10	200	\$3.25
BP100	1"	KD, KA 40,45	Regular	10	200	\$3.66
BP125	1-1/4"	KD, KA 51	Regular	10	100	\$5.12
BP125LS	1-1/4"	KD, KA 51,59	Long	10	50	\$5.42
BP150	1-1/2"	KD, KA 60,61,65	Regular	10	100	\$5.87
BP150LS	1-1/2"	KD, KA 60,65	Long	10	50	\$6.17
BP175	1-3/4"	KD, KA 70,75	Regular	5	75	\$8.28
BP200	2"	KD, KA 80	Regular	5	75	\$10.99

***Sold in box quantities only.**

REKEYABLE PADLOCKS · SCHLAGE COMPOSITE OR WEISER KEYWAY



Schlage composite fits "C" through "K" keyways

Part #	Width	Shackle	Keying	Price Each
RB175SC-COMP	1-3/4" - 45mm	1" Opening	Schlage Composite, 0-bit	\$40.00
RB175SC-COMP-LS*	1-3/4" - 45mm	2-1/4" Opening	Schlage Composite, 0-bit	\$41.50
RB175WSR-D-NL	1-3/4" - 45mm	1" Opening	Weiser, 0-bit	\$40.00
RB175WSR-D-NLLS*	1-3/4" - 45mm	2-1/4" Opening	Weiser, 0-bit	\$41.50

*LS = Long Shackle.

Keying Charges for RB175 Rekeyable Brass Padlocks	Price Each
Custom, non-stock or master keying (includes 2 keys/lock + 1 master key)	\$6.00
Grand master keying (includes 2 keys/lock + 1 master key and 1 grandmaster key)	\$8.00
Additional cut keys	\$3.25
Additional cut master keys	\$3.25

CORBIN/RUSSWIN · INTERCHANGEABLE CORE PADLOCK BODIES



Part #	Width	Shackle	Keying*	Price Each
CRB200-IC6	2" - 50mm	7/8" (25mm) Opening	Accepts Corbin/Russwin Recore Cylinders	\$42.00
CRB200-IC6-LS*	2" - 50mm	2-5/8" (65mm) Opening	Accepts Corbin/Russwin Recore Cylinders	\$43.50

*LS = Long Shackle

***Padlocks are sold less core.**



BRASS PADLOCKS





KEYBLANKS - For Brass Padlocks

Item	Description	Packaged	Price per Bag
361A or 361B	Fits B075	100/bag	\$56.00
362A or 362B	Fits B100	100/bag	\$56.00
363A or 363B	Fits B125	100/bag	\$56.00
364A or 364B	Fits B150, B175, B200	100/bag	\$56.00
365A or 365B	Fits B200, B250	100/bag	\$56.00
366A or 366B	Fits B250	100/bag	\$66.00



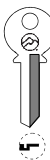









Item	Description	Packaged	Price per Box
KB220	Fits BP100 - 3/4" Padlock	50/box	\$28.00
KB225	Fits BP100 - 1" Padlock	50/box	\$28.00
KB235	Fits BP125 - 1-1/4" Padlock	50/box	\$28.00
KB240	Fits BP150 - 1-1/2" Padlock	50/box	\$28.00
KB240	Fits BP175 - 1-3/4" Padlock	50/box	\$28.00
KB250	Fits BP200 Padlock	50/box	\$28.00

See padlock keyblank charts below to choose the correct blank.

Mountain Series Padlocks Keyblank Chart

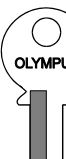
<p>BP075 3/4" Padlock Keyblanks</p>  <p>KB220 KA & KD Padlocks</p>	<p>BP100 1" Padlock Keyblanks</p>  <p>KB225 KA & KD Padlocks</p>	<p>BP125 1-1/4" Padlock Keyblanks</p>  <p>KB235 KA & KD Padlocks</p>
<p>BP150 & BP175 1-1/2" & 1-3/4" Padlock Keyblanks</p>  <p>KB240 KA & KD Padlocks</p>	<p>BP200 2" Padlock Keyblanks</p>  <p>KB250 KA & KD Padlocks</p>	

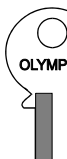
Olympus Series Padlocks Keyblank Chart

<p>Fits B075</p>  <p>Fits: B075A-16 KD - May take either blank</p> <p>#361A</p>	<p>Fits B075</p>  <p>Fits: B075A-5 KD - May take either blank</p> <p>#361B</p>	<p>Fits B100</p>  <p>Fits: B100A-10 KD - May take either blank</p> <p>#362A</p>	<p>Fits B100</p>  <p>Fits: B100A-10 KD - May take either blank</p> <p>#362B</p>
<p>Fits B125</p>  <p>Fits: B125A-1 KD - May take either blank</p> <p>#363A</p>	<p>Fits B125</p>  <p>Fits: B125A-3 KD - May take either blank</p> <p>#363B</p>	<p>Fits B150, B175 & B200</p>  <p>Fits: B150A-4 B150A-12 B175A-14 B200A-14 KD - May take either blank</p> <p>#364A</p>	<p>Fits B150, B175 & B200</p>  <p>Fits: B150A-2 B150A-9 B150A-11 B175A-15 B200A-15 KD - May take either blank</p> <p>#364B</p>
<p>Fits B200 & B250</p>  <p>Fits: B200A-6 B200A-8 B250A-6 B250A-8 KD - May take either blank</p> <p>#365A</p>	<p>Fits B200 & B250</p>  <p>Fits: B200A-7 B250A-7 KD - May take either blank</p> <p>#365B</p>	<p>Fits B200</p>  <p>Fits: B250A-18 B250A-20 B250A-22 KD - May take either blank</p> <p>#366A</p>	<p>Fits B200</p>  <p>Fits: B250A-19 B250A-21 KD - May take either blank</p> <p>#366B</p>



TERMS, CONDITIONS & WARRANTY

Conditions of Sale

Payment Terms: 2% 10 days, net 30 days. All payment terms are subject to credit approval.

Remittance Address: All payments should be sent by mail to: Olympus Lock, Inc., PO Box 1277, Lynnwood, WA 98046

Minimum Order: \$25.00 net excluding freight.

Minimum Annual Purchases: \$5,000.00 net excluding freight for open account status.

Prices: Olympus Lock, Inc. reserves the right to change pricing at any time and without prior notice.

Conditions: All specifications are subject to withdrawal or change at any time and without prior notice. Olympus Lock reserves the right to refuse orders which may be submitted. All prices F.O.B. Lynnwood, Washington, US Funds.

Office Hours & Contact Information

Office Hours: 7:00 am to 4:00 pm Pacific Standard Time

Phone: 206-362-3290

Toll-Free: 800-525-0954

Fax: 206-362-3569

Street Address: 18424 Highway 99, Lynnwood, WA 98037

Remittance Address: PO Box 1277, Lynnwood, WA 98046

Website: www.olympus-lock.com

Company email: info@olympus-lock.com

U.S. Shipments

All merchandise is shipped F.O.B. from our Lynnwood, Washington warehouse and becomes the property of the customer when accepted by the carrier. Olympus Lock will pay freight charges on orders of \$1,000.00 net or more to a single destination within the continental U.S.A. (excluding Alaska) via the carrier of our choice. For Hawaii and Alaska Customers: Olympus will pay freight on shipments of \$1,000.00 net or more to closest West Coast port.

Canadian Shipments

All merchandise is shipped F.O.B. our Lynnwood, Washington warehouse and becomes the property of the customer when accepted by the carrier. Olympus Lock will pay freight charges on Canadian orders of \$1,000.00 net or more to closest U.S.A. border crossing via the carrier of our choice provided this information is clearly specified at time of order. Olympus Lock will pay freight charges on Canadian orders of \$2,000.00 net or more to a single Canadian destination via the carrier of our choice. All duty and/or customs charges are the sole responsibility of the customer.

Cancellations

Cancellations or alterations to orders will be accepted only when the cancellation or alteration can be made without loss to Olympus Lock. Orders for non-stock and/or custom items may not be cancelled after work has begun.

Delivery

Claims resulting from loss, shortages or damage-in-transit must be reported to Olympus Lock within 15 days of delivery.

Any claims resulting from shortages, overages, or the shipment of incorrect products by Olympus Lock must be reported to Olympus Lock within 15 days of delivery.

Olympus Lock does not assume responsibility for any damages resulting from any delays in delivery.

Returned Goods Policy

No material is to be returned without our verbal or written permission in advance. All returned goods require a Returned Goods Authorization (RGA) number to be obtained from Olympus Lock prior to returning the goods. Only products purchased within the last 12 months may be returned. Any products purchased more than 12 months prior are ineligible for return. Whether goods may be returned will be at the sole discretion of Olympus Lock, Inc. Merchandise returned must be identified as to original purchase order number, date of purchase, and shipper's name and address.

A 25% restocking fee will apply to all returned goods which are found not to be the responsibility of Olympus Lock.

All goods must be shipped freight prepaid and received at our warehouse within 30 days of receiving an RGA number. Goods not received within 30 days of RGA issuance or for which an RGA number was not issued will not be returned and no credit will be issued.

Returned goods must be received in first-class resaleable condition and in original factory packaging. The determination of "first-class resaleable condition" will be at the sole discretion of Olympus Lock. Goods that are returned and determined by Olympus Lock not to be in first-class resaleable condition will not be returned, will be scrapped at the factory, and no credit will be issued.

The following are non-returnable:

1. Custom keyed, non-stock items
2. Goods that have been installed
3. Goods that required custom stamping
4. Goods with custom, special order finishes
5. Products or parts that have been modified
6. Obsolete or discontinued items

Limited Warranty

Olympus Lock warrants that its products are free from defects in workmanship and materials under normal installation, use and service. This warranty does not cover defects or damages arising from improper installation, improper maintenance, ordinary wear and tear, misuse or abuse.

The only liability of the company in tort or in contract, whether under this warranty or otherwise shall be limited to repair or replacement of products which are returned prepaid to us within one year of the date of original purchase.

This is a limited warranty and is in lieu of all other representations and expressed or implied warranties. Under no circumstances shall Olympus Lock be made liable for any incidental or consequential damages or losses.

OLYMPUS[®] LOCK, INC.

The cabinet lock innovators.

Hours of Operation: 7:00 am - 4:00 pm Pacific Time



18424 Highway 99 · Lynnwood, WA 98037 · 206-362-3290 · 800-525-0954 · Fax 206-362-3569
info@olympus-lock.com · www.olympus-lock.com



Olympus is a registered trademark of the Frank J. Martin Company. Copyright © 1989 - 2008 Olympus Lock, Inc. all rights reserved. Other products and companies referred to herein are trademarks or registered trademarks of their respective companies or mark holders. Information and prices listed in this document are subject to change at any time without notice. All box and case weights are approximate. 07/08.