







# PRICE LIST - JUNE 2011

	<u>PAGE #</u>
<b>1000 SERIES ELECTROMAGNETIC LOCKS</b>	
#MM300 - MINI-MAGNETIC LOCKS - CABINETS/DRAWERS	2
#1000 - INDUSTRIAL MAGNETIC LOCKS & ACCESSORIES	2
#1100 - MAGNETIC LOCKS - OUTSWING DOORS	3
#ML1100 - MORTISED MAGNETIC LOCKS & PULLS	3
#TJ1100 - MAGNETIC LOCKS - INSWING DOORS	4
#1100 - MAGNETIC LOCK - OPTIONS & CUSTOM HOUSINGS	5
#1100 - MAGNETIC LOCK - SPECIAL FINISHES	6
#1180 - MAGNETIC LOCK - FILLER PLATES	7
#1180 - MAGNETIC LOCK - FILLER PLATE-SPECIAL FINISHES	8
#1190 - MAGNETIC LOCK - ANGLE MOUNTING BRACKETS	9
#1190 - MAGNETIC LOCK - ANGLE MOUNTING BRACKET FINISHES	10
#1190 - MAGNETIC LOCK - Z-BRACKET SPACER BLOCKS	11
#1190 - ARMATURE MOUNTING BRACKETS-HERCULITE BRACKETS	12
<b>3000 SERIES ELECTRIC STRIKES</b>	
#3300 - ANSI STYLE STRIKES	13
#3301 - WOOD FRAME STRIKES	13
<b>4000 SERIES POWER SUPPLIES &amp; CONTROLLERS</b>	
#4000 - PLUG-IN POWER SUPPLIES	14
#4200 - POWER SUPPLIES WITH SWITCHING REGULATOR	14
#4200 - POWER SUPPLY - OPTIONS	14
#4700 - PLC MANTRAPS / INTERLOCKS 2 - 4 DOORS	15
#4900 - PLC MANTRAPS / INTERLOCKS UP TO 120 DOORS	16
<b>5000 SERIES ACTUATING CONTROLS</b>	
#5100 - MORTISE KEY SWITCHES	17
#5200 - PUSH BUTTON SWITCHES	18 & 19
#5230 - SNAP ACTION PUSH BUTTONS / UNDER DESK CONSOLES	20
#5240 - ELECTRIC KEY SWITCHES / UNDER DESK CONSOLES	21
***NEW*** #5260 - PUSH BUTTON SWITCHES 3/4" SQUARE ACTUATOR	22
#5276 - PUSH BUTTON SWITCHES GUARDED / HEAVY DUTY	23
#5277 - PIEZO ELECTRIC SWITCHES	24
#5286 - PUSH PLATE SWITCHES	25, 26, 27
#5287 - HEAVY DUTY PUSH BUTTON SWITCHES	28
<b>6000 SERIES ACCESSORIES</b>	
#6220 - DOOR CORDS	29
#6420 - PANIC EGRESS BARS	29
#6500 - EMERGENCY PULL STATIONS & ANTI TAMPER COVERS	30
#6612 - REX MOTION DETECTORS	30
<b>7000 SERIES ANNUNCIATORS</b>	
#7101 - DELAYED EGRESS SYSTEM	31
#7201 - HI-INTENSITY LED INDICATORS & PIEZO SOUNDERS	32
#7200 - MULTI-ZONE ANNUNCIATORS	33
#7281 - DOOR EXIT ALARM / ANNUNCIATORS	34
#7286 - DOOR PROP ALARM / ANNUNCIATORS	35
#7600 - MULTI-ZONE ANNUNCIATOR / CONTROLLERS	36
#7600 - ANNUNCIATOR PANEL & RACK SIZE INFORMATION	37
<b>8000 SERIES ACCESS CONTROL SYSTEMS</b>	
#8100 - KEYPAD ACCESS CONTROL	38
<b>REPAIR PARTS &amp; MISCELLANEOUS</b>	
#1100 - ELECTROMAGNETIC LOCK PARTS	39
#5000 - ACTUATING CONTROL SWITCH PARTS	40
ELECTRICAL BOXES & ACCESSORIES	40
<b>CREDIT APPLICATION &amp; SALES POLICIES</b>	41, 42



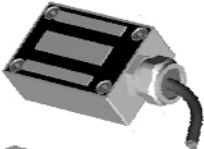
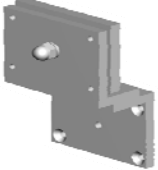

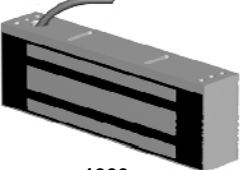
# MAGNETIC LOCKS

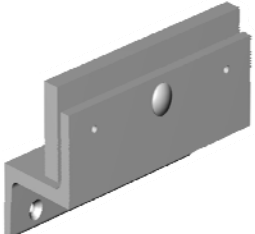
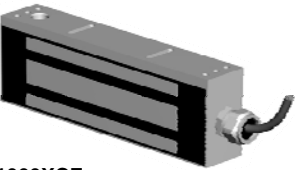
	<u>PART #</u>	<u>DESCRIPTION</u>	<u>LIST PRICE</u>
<b>MINI SERIES CABINET &amp; DRAWER LOCKS</b>			
  		<b><u>MINI-MITE LOCK</u></b>	
	MM-300	300 LB MINI-MITE LOCK 12/24 VDC (DUAL VOLTAGE) WITH STAINLESS STEEL HOUSING (3-1/4" x 2-1/4" x 1-3/4" OVERALL)	\$185.00
	TJMM-300	FOR INSWING APPLICATIONS INCLUDES Z-BRACKET	\$285.00
	MM-D1	ACCESSORY ARMATURE ANGLE BRACKET	\$40.00
	MM-D2	TJ BACK MOUNTING BRACKET	\$40.00
	MM-ZD1	MINI MITE Z- BRACKET	\$60.00
		<b><u>NARROW MINI-MITE LOCK</u></b>	
	MM-300N	300 LB NARROW LINE MINI-MITE LOCK (SPECIFY 12 OR 24 VDC) STAINLESS STEEL ENCLOSURE	\$200.00
	TJMM-300N	FOR INSWING APPLICATIONS INCLUDES Z-BRACKET	\$300.00
	MM-N1	NARROW ANGLE BRACKET 1-1/2x1-1/2 X 6"	\$40.00
MM-N2	TJ BACK MOUNTING BRACKET	\$40.00	
MM-ZN1	NARROW MINI-MITE Z- BRACKET	\$60.00	
<b>1000 SERIES INDUSTRIAL ELECTROMAGNETIC LOCKS</b>			
   	1000	<b><u>INDUSTRIAL LOCK - OUTSWING DOORS</u></b> 1200 LB LOCK 12/24 VDC (DUAL VOLTAGE - FIELD SELECTABLE) FOR SURFACE MOUNTING ON OUTSWING DOORS STAINLESS STEEL HOUSING	\$340.00
	TJ-1000	1200 LB LOCK 12/24 VDC (DUAL VOLTAGE - FIELD SELECTABLE) FOR SURFACE MOUNTING ON INSWING DOORS INCLUDES ANGLE MOUNTING BRACKET AND ARMATURE "Z" BRACKET	\$425.00
	1095-00	<b><u>OPTIONAL MOUNTING BRACKET</u></b> USE FOR GATE OR SLIDING DOOR APPLICATIONS	\$50.00
	1099-00	<b><u>GATE/INSWING - CONVERSION KIT</u></b> KIT INCLUDES 1095-00 ANGLE BRACKET & 1196-00 Z-BRACKET FOR MOUNTING OF CONDUIT FITTED LOCKS OR TOP JAMB MOUNTING (IN-SWING DOORS) OF STANDARD INDUSTRIAL LOCK <b>(KIT INCLUDED WITH TJ-1000)</b>	\$148.00
		<b><u>1000 SERIES OPTIONS</u></b>	
	xD	ADD SPDT DOOR POSITION SWITCH (SINGLE)	\$45.00
	xCF	ADD CONDUIT FITTING (FOR 1/2" RIGID CONDUIT) <b>(THE 1000XCF COMES WITH 10' LEADS)</b>	\$20.00
	1000XCF		

FILLER PLATES & ANGLE BRACKETS pgs. 8-12

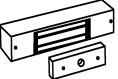
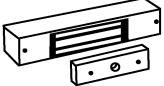
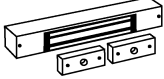
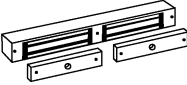
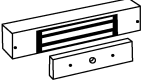
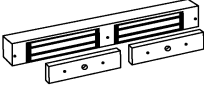
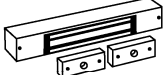

# MAGNETIC LOCKS

	<u>PART #</u>	<u>DESCRIPTION</u>	<u>LIST PRICE</u>
<b>1100 SERIES</b>	<b>ELECTROMAGNETIC LOCKS</b>		
	1106	<b><u>650 LB SINGLE MAGLOCK</u></b> JUNIOR 650 LB LOCK 12/24 VDC (DUAL VOLTAGE - FIELD SELECTABLE)	\$340.00
	1110	<b><u>1200 LB SINGLE MAGLOCK</u></b> SINGLE DOOR 1200 LB LOCK 12/24 VDC (DUAL VOLTAGE - FIELD SELECTABLE)	\$390.00
	1115	<b><u>600 LB. SPLIT ARMATURE MAGLOCK</u></b> SPLIT ARMATURE DOUBLE LOCK 12/24 VDC (DUAL VOLTAGE - FIELD SELECTABLE)	\$430.00
	1120	<b><u>1200 LB DOUBLE MAGLOCK</u></b> DOUBLE DOOR 1200 LB 12/24 VDC (DUAL VOLTAGE - FIELD SELECTABLE)	\$780.00
	1150	<b><u>1500 LB SINGLE MAGLOCK</u></b> SINGLE DOOR 1500 LB 12/24 VDC (DUAL VOLTAGE - FIELD SELECTABLE)	\$440.00
	1152	<b><u>1500 LB DOUBLE MAGLOCK</u></b> DOUBLE DOOR 1500 LB 12/24 VDC (DUAL VOLTAGE - FIELD SELECTABLE)	\$880.00
	1155	<b><u>750 LB. SPLIT ARMATURE MAGLOCK</u></b> SPLIT ARMATURE DOUBLE LOCK 12/24 VDC (DUAL VOLTAGE - FIELD SELECTABLE)	\$490.00

## 1100 SERIES MORTISED LOCK APPLICATIONS

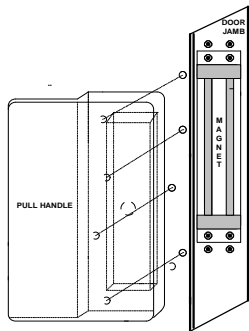

<b>ML-1100</b>	<b><u>MORTISED MAGLOCKS</u></b> MORTISED 1000 LB LOCK INCLUDES RECESSED MOUNTING BRACKET & ARMATURE <b>24 VDC ONLY</b>	\$410.00
<b>DPA1100</b>	<b><u>ALUMINUM DOOR PULLS</u></b> DOOR PULL FOR #ML-1100 MORTISED LOCK	\$340.00
<b>(SUFFIX) XDBA</b>	<i>If DPA pull &amp; ML lock are ordered together the armature will be factory mounted in the DPA pull</i>  FOR DARK BRONZE ANODIZED FINISH PULL  OTHER FINISHES AVAILABLE CHECK WITH FACTORY	<b>ADD \$100.00</b>

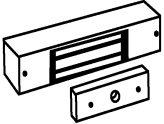
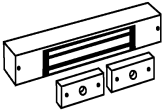
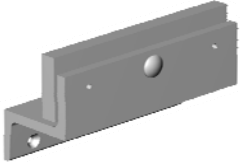

# MAGNETIC LOCKS

	<u>PART #</u>	<u>DESCRIPTION</u>	<u>LIST PRICE</u>
<b>TJ1100 SERIES</b>		<b>IN-SWINGING DOOR APPLICATIONS</b>	
	TJ1106	<b><u>650 LB SINGLE MAGLOCK</u></b> JUNIOR 650 LB LOCK 12/24 VDC (DUAL VOLTAGE - FIELD SELECTABLE, INCLUDES TOP JAMB LOCK HOUSING w/ Z-BRACKET FOR ARMATURE)	\$420.00
	TJ1110	<b><u>1200 LB SINGLE MAGLOCK</u></b> SINGLE DOOR 1200 LB LOCK 12/24 VDC (DUAL VOLTAGE - FIELD SELECTABLE, INCLUDES TOP JAMB LOCK HOUSING w/ Z-BRACKET FOR ARMATURE)	\$480.00
	TJ1115	<b><u>600 LB. SPLIT ARMATURE MAGLOCK</u></b> SPLIT ARMATURE DOUBLE LOCK 12/24 (DUAL VOLTAGE - FIELD SELECTABLE, INCLUDES TOP JAMB LOCK HOUSING w/ Z-BRACKET FOR ARMATURE)	\$560.00
	TJ1120	<b><u>1200 LB DOUBLE MAGLOCK</u></b> DOUBLE DOOR 1200 LB 12/24 (DUAL VOLTAGE - FIELD SELECTABLE, INCLUDES TOP JAMB LOCK HOUSING w/ Z-BRACKET FOR ARMATURE)	\$960.00
	TJ1150	<b><u>1500 LB SINGLE MAGLOCK</u></b> SINGLE DOOR 1500 LB 12/24 (DUAL VOLTAGE - FIELD SELECTABLE, INCLUDES TOP JAMB LOCK HOUSING w/ Z-BRACKET FOR ARMATURE)	\$560.00
	TJ1152	<b><u>1500 LB DOUBLE MAGLOCK</u></b> DOUBLE DOOR 1500 LB 12/24 (DUAL VOLTAGE - FIELD SELECTABLE, INCLUDES TOP JAMB LOCK HOUSING w/ Z-BRACKET FOR ARMATURE)	\$1,120.00
	TJ1155	<b><u>750 LB. SPLIT ARMATURE MAGLOCK</u></b> SPLIT ARMATURE DOUBLE LOCK 12/24 (DUAL VOLTAGE - FIELD SELECTABLE, INCLUDES TOP JAMB LOCK HOUSING w/ Z-BRACKET FOR ARMATURE)	\$770.00
		TYPICAL Z-BRACKET FOR MOUNTING ARMATURE INCLUDED WITH EACH TOP JAMB LOCK	
		SEE PAGE 37 FOR Z-BRACKET PRICING AS A SPARE PART ONLY (ALL TJ LOCKS INCLUDE A Z-BRACKET)	
		<b>1196 Z-BRACKET</b>	



# MAGNETIC LOCKS

<b>1100 SERIES</b>	<b>PART #</b>	<b>DESCRIPTION</b>	<b>LIST PRICE</b>
		<b>OPTIONAL MAGNETIC LOCK FEATURES</b>	
	<u>(SUFFIX)</u>	<u>1100 SERIES OPTIONS (ADD TO LOCK):</u>	<u>(ADD)</u>
	xL	ADD 1 LED (BICOLOR RED / GREEN)	\$30.00
	xD	ADD SPDT DOOR POSITION SWITCH (SINGLE)	\$45.00
	x2D	ADD 2 SPDT DOOR POSITION SWITCHES (1115/1120/1152/1155)	\$90.00
	XDD	ADD DPDT DOOR POSITION SWITCH (SINGLE)	\$90.00
	xB	ADD 1 MAGNETIC BOND SENSOR <b>(NOT AVAILABLE FOR 1115,1155 SERIES SPLIT ARMATURE LOCKS)</b>	\$90.00
	x2B	ADD 2 MAGNETIC BOND SENSORS DOUBLE(1120/1152)	\$180.00
	xCF	ADD CONDUIT FITTING (FOR 1/2" RIGID CONDUIT) (THE 1000XCF COMES WITH 10' LEADS)	\$10.00 \$20.00
	xCT	ADD COVER TAMPER SWITCH	\$44.00
	xTS	ADD TAMPER RESISTANT SCREWS/DRIVER	\$12.00
	xEDR	ADD ATTEMPTED EGRESS SWITCH & DOOR SWITCH w/ ARMATURE MOUNTING ASSEMBLY (FOR SINGLE DOOR w/ EDR SYSTEM-101) <b>ONLY AVAILABLE WITH 1106 &amp; 1110 SERIES LOCKS</b>	\$120.00

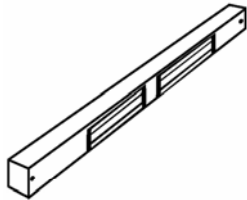

	<u>FULL WIDTH HOUSINGS (ADD TO LOCK):</u>	<u>(ADD)</u>
LW-	ADD TO 1106/1110/1150 MAGLOCK FOR SINGLE LOCK HOUSINGS UP TO 48" WIDE	\$310.00
LW-	ADD TO 1115/1120/1152 MAGLOCK FOR DOUBLE LOCK HOUSINGS UP TO 72" WIDE	\$380.00



	<u>FULL HEIGHT HOUSINGS (ADD TO LOCK):</u>	<u>(ADD)</u>
LV-	ADD TO 1106/1110/1150 MAGLOCK - FOR SINGLE LOCK HOUSINGS UP TO 96" LONG	\$410.00
LV-	ADD TO 1120/1152 MAGLOCK - FOR DOUBLE LOCK HOUSINGS UP TO 96" LONG	\$430.00

**FOR OTHER CUSTOM LOCKS OR HOUSINGS (CALL FOR QUOTE)**

**FOR CUSTOM FINISHES (CALL FOR QUOTE)**



# MAGNETIC LOCKS

<b>1100 SERIES</b>	<b>PART #</b>	<b>DESCRIPTION</b>	<b>LIST PRICE</b>
		<b>OPTIONAL SPECIAL LOCK FINISHES</b>	
	<b>(SUFFIX)</b>	<b>ANODIZING (ADD TO LOCK PRICE):</b>	
	xDBA	DARK BRONZE ANODIZE (US10D) -	<b>(ADD)</b>
	xSBA	SATIN BLACK ANODIZE -	
		ADD FOR 1106 SERIES	<b>\$40.00</b>
		ADD FOR 1110 , 1115 SINGLE SERIES	<b>\$50.00</b>
		ADD FOR 1120 DOUBLE SERIES	<b>\$80.00</b>
		ADD FOR 1150, 1155 SINGLE SERIES	<b>\$60.00</b>
		ADD FOR 1152 DOUBLE SERIES	<b>\$90.00</b>
		ADD FOR TJ1106 TOP JAMB JR.	<b>\$60.00</b>
		ADD FOR TJ1110, TJ1115 TOP JAMB SINGLE	<b>\$62.00</b>
		ADD FOR TJ1120 TOP JAMB DOUBLE	<b>\$112.00</b>
		ADD FOR TJ1150, TJ1155 TOP JAMB SINGLE	<b>\$70.00</b>
		ADD FOR TJ1152 TOP JAMB DOUBLE	<b>\$120.00</b>
	<b>(SUFFIX)</b>	<b>PLATING (ADD TO LOCK PRICE):</b>	
	XUS26	POLISHED CHROME -	
	XUS26D	SATIN CHROME -	
	XUS3	POLISHED BRASS -	<b>(ADD)</b>
	XUS4	SATIN BRASS -	
		ADD FOR 1106 SERIES	<b>\$190.00</b>
		ADD FOR 1110 , 1115 SINGLE SERIES	<b>\$240.00</b>
		ADD FOR 1120 DOUBLE SERIES	<b>\$350.00</b>
		ADD FOR 1150, 1155 SINGLE SERIES	<b>\$250.00</b>
		ADD FOR 1152 DOUBLE SERIES	<b>\$370.00</b>
		ADD FOR TJ1106 TOP JAMB JR.	<b>\$280.00</b>
		ADD FOR TJ1110,TJ1115 TOP JAMB SINGLE	<b>\$450.00</b>
		ADD FOR TJ1120 TOP JAMB DOUBLE	<b>\$540.00</b>
		ADD FOR TJ1150, TJ1155 TOP JAMB SINGLE	<b>\$470.00</b>
		ADD FOR TJ1152 TOP JAMB DOUBLE	<b>\$570.00</b>



# MAGNETIC LOCKS

1180 SERIES	PART #	DESCRIPTION	LIST PRICE
	<b>FILLER PLATES</b>		
	<b>3/8" FILLERS</b>		
	1183-00	3/8 x1" 1000 SERIES FILLER 8-1/4" LONG	\$28.00
	1183-06	3/8 x1" 1106 SERIES FILLER 8-1/4" LONG	\$28.00
	1183-10	3/8 x1" 1110/1115 SERIES FILLER 12-1/2" LONG	\$40.00
	1183-20	3/8 x1" 1120 SERIES FILLER 23" LONG	\$48.00
	1183-50	3/8 x1" 1150/1155 SERIES FILLER 12" LONG	\$40.00
	1183-52	3/8 x1" 1152 SERIES FILLER 24" LONG	\$48.00
	<b>EXTRA WIDE FILLER PLATES</b>		
	1183-00-W	EXTRA WIDE 3/8 x 1-1/2" 1000 FILLER 8-1/4" LONG	\$36.00
	1183-06-W	EXTRA WIDE 3/8 x 1-3/4" 1106 FILLER 8-1/4" LONG	\$36.00
	1183-10-W	EXTRA WIDE 3/8 x 1-3/4" 1110/1115 FILLER 12-1/2"	\$48.00
	1183-20-W	EXTRA WIDE 3/8 x 1-3/4" 1120 FILLER 23" LONG	\$56.00
	1183-50-W	EXTRA WIDE 3/8 x 2" 1150/1155 FILLER 12"	\$48.00
	1183-52-W	EXTRA WIDE 3/8 x 2" 1150/1155 FILLER 24"	\$56.00
	<b>1/2" FILLERS</b>		
	1184-00	1/2"x1" 1000 SERIES FILLER 8-1/4" LONG	\$32.00
	1184-06	1/2"x1" 1106 SERIES FILLER 8-1/4" LONG	\$32.00
	1184-10	1/2"x1" 1110/1115 SERIES FILLER 12-1/2" LONG	\$42.00
	1184-20	1/2"x1" 1120 SERIES FILLER 23" LONG	\$52.00
	1184-50	1/2"x1" 1150/1155 SERIES FILLER 12" LONG	\$42.00
	1184-52	1/2"x1" 1152 SERIES FILLER 24" LONG	\$52.00
	<b>EXTRA WIDE FILLER PLATES</b>		
	1184-00-W	EXTRA WIDE 1/2 x 1-1/2" 1000 FILLER 8-1/4" LONG	\$42.00
	1184-06-W	EXTRA WIDE 1/2 x 1-3/4" 1106 FILLER 8-1/4" LONG	\$42.00
	1184-10-W	EXTRA WIDE 1/2 x 1-3/4" 1110/1115 FILLER 12-1/2"	\$52.00
	1184-20-W	EXTRA WIDE 1/2 x 1-3/4" 1120 FILLER 23" LONG	\$62.00
	1184-50-W	EXTRA WIDE 1/2 x 2" 1150/1155 FILLER 12" LONG	\$52.00
	1184-52-W	EXTRA WIDE 1/2 x 2" 1152 FILLER 24" LONG	\$62.00
	<b>5/8" FILLERS</b>		
	1185-00	5/8"x1" 1000 SERIES FILLER 8-1/4" LONG	\$36.00
	1185-06	5/8"x1" 1106 SERIES FILLER 8-1/4" LONG	\$36.00
	1185-10	5/8"x1" 1110/1115 FILLER 12-1/2" LONG	\$44.00
	1185-20	5/8"x1" 1120 SERIES FILLER 23" LONG	\$56.00
	1185-50	5/8"x1" 1150/1155 SERIES FILLER 12" LONG	\$44.00
	1185-52	5/8"x1" 1152 SERIES FILLER 24" LONG	\$56.00
	<b>EXTRA WIDE FILLER PLATES</b>		
	1185-00-W	EXTRA WIDE 5/8 x 1-1/2" 1000 FILLER 8-1/4" LONG	\$48.00
	1185-06-W	EXTRA WIDE 5/8 x 1-3/4" 1106 FILLER 8-1/4" LONG	\$48.00
	1185-10-W	EXTRA WIDE 5/8 x 1-3/4" 1110 FILLER 12-1/2" LONG	\$56.00
	1185-20-W	EXTRA WIDE 5/8 x 1-3/4" 1120 FILLER 23" LONG	\$68.00
	1185-50-W	EXTRA WIDE 5/8 x 2" 1150 FILLER 12" LONG	\$56.00
	1185-52-W	EXTRA WIDE 5/8 x 2" 1152 FILLER 24" LONG	\$68.00

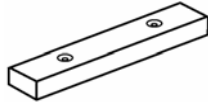

1180 SERIES FILLER PLATE FOR FRAME WITH NARROW STOP

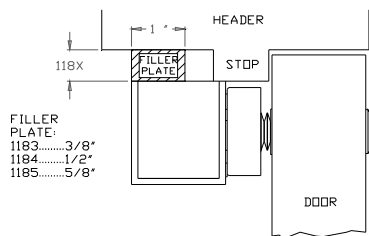

1180-W SERIES WIDE FILLER PLATE FOR FRAME WITH LIP STOP

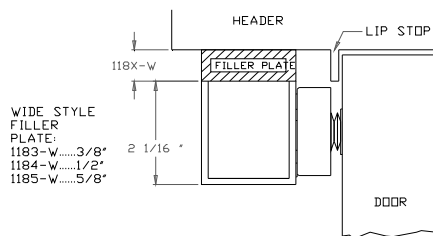



# MAGNETIC LOCKS

---

---

<b>1180 SERIES</b>	<u>PART #</u>	<u>DESCRIPTION</u>	<u>LIST PRICE</u>
		<b>CUSTOM FINISHES - STANDARD FILLER PLATES</b>	
	<u>(SUFFIX)</u>	<u>SPECIAL FINISHES ADD TO FILLER PLATES</u>	<u>(ADD)</u>
	xDBA	ADD FOR DARK BRONZE ANODIZED -	\$18.00
	xSBA	ADD FOR SATIN BLACK ANODIZED -	\$18.00
	xUS26	ADD FOR POLISHED CHROME -	
	xUS26D	ADD FOR SATIN CHROME -	
	xUS3	ADD FOR POLISHED BRASS -	
	xUS4	ADD FOR SATIN BRASS -	
		1106 (SINGLE LOCK) FILLER PLATES	\$40.00
		1110/1115 (SINGLE LOCK) FILLER PLATES	\$50.00
		1150/1155 (SINGLE LOCK) FILLER PLATES	\$60.00
		1120 (DOUBLE LOCK) FILLER PLATES	\$90.00
		1152 (DOUBLE LOCK) FILLER PLATES	\$90.00



# MAGNETIC LOCKS

1190 SERIES	PART #	DESCRIPTION	LIST PRICE
<b>ANGLE BRACKETS</b>			
<b>1" x 1" ANGLE BRACKET</b>			
	1191-00	1"X1" 1000 SERIES ANGLE 8-1/4" LONG	\$42.00
	1191-06	1"X1" 1106 SERIES ANGLE 8-1/4" LONG	\$42.00
	1191-10	1"X1" 1110/1115 SERIES ANGLE 12-1/2"LONG	\$55.00
	1191-20	1"X1" 1120 SERIES ANGLE 23" LONG	\$75.00
	1191-50	1"X1" 1150/1155 SERIES ANGLE 12"LONG	\$55.00
	1191-52	1"X1" 1152 SERIES ANGLE 24" LONG	\$75.00
	<b>1-1/2" x 1-1/2" ANGLE BRACKET</b>		
	1192-00	1-1/2"X 2" 1000 SERIES ANGLE 8-1/4"LONG	\$44.00
	1192-06	1-1/2"X1-1/2" 1106 SERIES ANGLE 8-1/4"LONG	\$44.00
	1192-10	1-1/2"X1-1/2" 1110/1115 SERIES ANGLE 12-1/2"LONG	\$58.00
	1192-20	1-1/2"X1-1/2" 1120 SERIES ANGLE 23" LONG	\$75.00
	1192-50	1-1/2"X1-1/2" 1150/1155 SERIES ANGLE 12"LONG	\$58.00
	1192-52	1-1/2"X1-1/2" 1152 SERIES ANGLE 24" LONG	\$75.00
	<b>2" x 1-1/2" ANGLE BRACKET</b>		
	1193-00	2"X 2" 1000 SERIES ANGLE 8-1/4" LONG	\$60.00
	1193-06	2"X1-1/2" 1106 SERIES ANGLE 8-1/4" LONG	\$60.00
	1193-10	2"X1-1/2" 1110/1115 SERIES ANGLE 12-1/2"LONG	\$77.00
	1193-20	2"X1-1/2" 1120 SERIES ANGLE 23" LONG	\$95.00
	1193-50	2"X1-1/2" 1150/1155 SERIES ANGLE 12"LONG	\$77.00
	1193-52	2"X1-1/2" 1152 SERIES ANGLE 24" LONG	\$95.00
	<b>2-1/2" x 2" ANGLE BRACKET</b>		
	1194-00	2-3/8"X2" 1000 SERIES ANGLE 8-1/4" LONG	\$65.00
	1194-06	2-1/2"X2" 1106 SERIES ANGLE 8-1/4" LONG	\$65.00
	1194-10	2-1/2"X2" 1110/1115 SERIES ANGLE 12-1/2"LONG	\$80.00
	1194-20	2-1/2"X2" 1120 SERIES ANGLE 23" LONG	\$100.00
	1194-50	2-1/2"X2" 1150/1155 SERIES ANGLE 12"LONG	\$80.00
	1194-52	2-1/2"X2" 1152 SERIES ANGLE 24" LONG	\$100.00

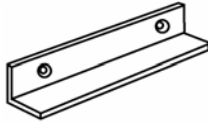

DEPTH X HEIGHT

**2" x 1-1/2" ANGLE BRACKET**

DEPTH X HEIGHT

**2-1/2" x 2" ANGLE BRACKET**

1194 ANGLE BRACKET

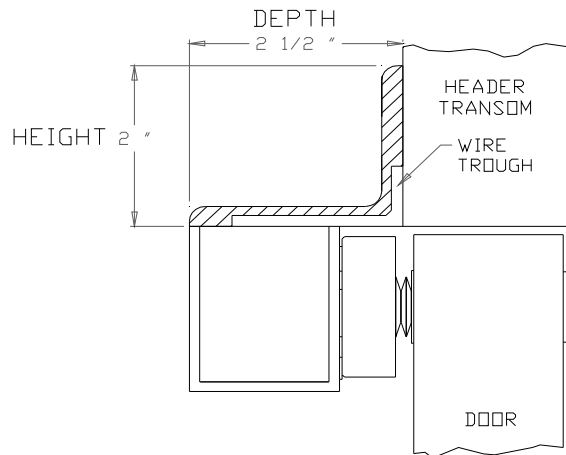



# MAGNETIC LOCKS

<b>1190 SERIES</b>	<b>PART #</b>	<b>DESCRIPTION</b>	<b>LIST PRICE</b>
		<b>CUSTOM FINISHES - ANGLE BRACKETS</b>	
	<u>(SUFFIX)</u>	<u>SPECIAL FINISHES ADD TO ANGLE BRACKETS</u>	<u>(ADD)</u>
	xDBA	ADD FOR DARK BRONZE ANODIZED - ALL STANDARD ANGLE BRACKETS	\$20.00
	xSBA	ADD FOR SATIN BLACK ANODIZED - ALL STANDARD ANGLE BRACKETS	\$20.00
	xUS26	ADD FOR POLISHED CHROME -	
	xUS26D	ADD FOR SATIN CHROME -	
	xUS3	ADD FOR POLISHED BRASS -	
	xUS4	ADD FOR SATIN BRASS -	
		1106 (SINGLE LOCK) ANGLE BRACKETS	\$50.00
		1110/1115 (SINGLE LOCK) ANGLE BRACKETS	\$60.00
		1150/1155 (SINGLE LOCK) ANGLE BRACKETS	\$80.00
		1120 (DOUBLE LOCK) ANGLE BRACKETS	\$120.00
		1152 (DOUBLE LOCK) ANGLE BRACKETS	\$140.00



# MAGNETIC LOCKS

**1190 SERIES**

**PART # DESCRIPTION LIST PRICE**  
**"Z" BRACKET ACCESSORIES**

**Z-BRACKET SPACERS & BLOCKS**

<b>1176-06S1</b>	1/8" SPACER FOR 1106	<b>\$40.00</b>
<b>1176-00S1</b>	1/8" SPACER FOR 1000	<b>\$42.00</b>
<b>1176-10S1</b>	1/8" SPACER FOR 1110/1150 (1120/1152, 2 REQUIRED)	<b>\$44.00</b>
<b>1176-15S1</b>	1/8" SPACER FOR 1115/1155 (2 REQUIRED)	<b>\$38.00</b>
<b>1176-06S2</b>	1/4" SPACER FOR 1106	<b>\$46.00</b>
<b>1176-00S2</b>	1/4" SPACER FOR 1000	<b>\$50.00</b>
<b>1176-10S2</b>	1/4" SPACER FOR 1110/1150 (1120/1152, 2 REQUIRED)	<b>\$52.00</b>
<b>1176-15S2</b>	1/4" SPACER FOR 1115/1155 (2 REQUIRED)	<b>\$42.00</b>
<b>1176-06B1</b>	1" BLOCK FOR 1106	<b>\$88.00</b>
<b>1176-00B1</b>	1" BLOCK FOR 1000	<b>\$92.00</b>
<b>1176-10B1</b>	1" BLOCK FOR 1110/1150 (1120/1152, 2 REQUIRED)	<b>\$96.00</b>
<b>1176-15B1</b>	1" BLOCK FOR 1115/1155 (2 REQUIRED)	<b>\$84.00</b>

**SPECIAL FINISH Z-BRACKETS, SPACERS & BLOCKS (Call for quote)**

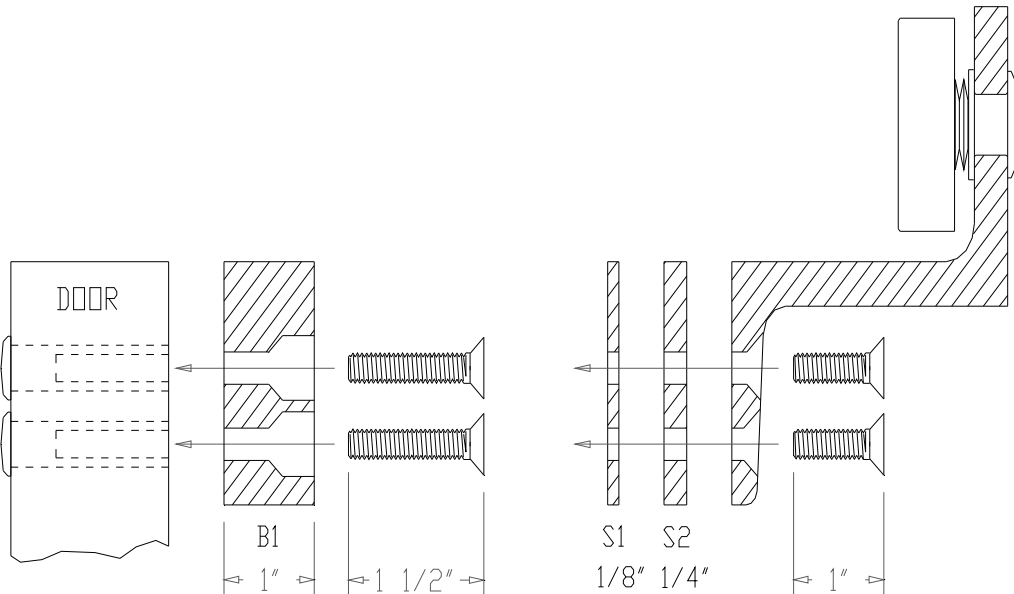

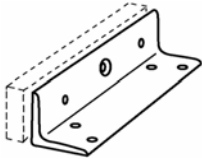

# MAGNETIC LOCKS

<b>1190 SERIES</b>	<b>PART #</b>	<b>DESCRIPTION</b>	<b>LIST PRICE</b>
		<b>ARMATURE MOUNTING BRACKETS</b>	
		<b><u>2" x 2" ARMATURE BRACKET w/ SEX NUT</u></b>	
	1195-06	ARMATURE BRACKET FOR 1106 LOCKS	\$56.00
	1195-10	ARMATURE BRACKET FOR 1110 LOCKS	\$68.00
	1195-15L	ARMATURE BRACKET FOR LEFT ARMATURE 1115	\$54.00
	1195-15R	ARMATURE BRACKET FOR RIGHT ARMATURE 1115	\$54.00
		<b><u>2-1/2" x 2-1/2" BRACKET w/ SEX NUT</u></b>	
		<b>FOR 1000 &amp; 1150 SERIES LOCKS</b>	
	1195-50	ARMATURE BRACKET FOR 1150 & 1000 LOCKS	\$76.00
	1195-55L	ARMATURE BRACKET FOR 1155 LEFT ARMATURE	\$60.00
	1195-55R	ARMATURE BRACKET FOR 1155 RIGHT ARMATURE	\$60.00
		<b><u>2-1/2" x 2-1/2" BRACKET w/ SEX NUT</u></b>	
	1197-06	ARMATURE BRACKET FOR 1106 LOCKS	\$70.00
	1197-10	ARMATURE BRACKET FOR 1110 LOCKS	\$80.00
		<b><u>2-1/2" x 3" BRACKET w/ SEX NUT</u></b>	
		<b>FOR 1000 &amp; 1150 SERIES LOCKS</b>	
	1197-50	ARMATURE BRACKET FOR 1150 & 1000 LOCKS	\$88.00
	<b>(SUFFIX)</b>	<b><u>ARMATURE BRACKET SPECIAL FINISHES</u></b>	
	xDBA	ADD FOR DARK BRONZE ANODIZED BRACKET	\$20.00
	xSBA	ADD FOR SATIN BLACK ANODIZED BRACKET	\$20.00
	xUS3	ADD FOR POLISHED BRASS ARMATURE BRACKET	\$80.00
	xUS26	ADD FOR POLISHED CHROME ARMATURE BRACKET	\$80.00
	xUS4	ADD FOR SATIN BRASS ARMATURE BRACKET	\$80.00
	xUS26D	ADD FOR SATIN CHROME ARMATURE BRACKET	\$80.00

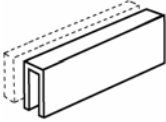
<b>1190 SERIES</b>	<b>PART #</b>	<b>DESCRIPTION</b>	<b>LIST PRICE</b>	
		<b>HERCULITE GLASS DOOR BRACKETS</b>		
		<b><u>1198 SERIES GLASS DOOR U-BRACKETS</u></b>		
		SATIN STAINLESS STEEL FINISH STANDARD (CHECK GLASS THICKNESS)		
	1198/50-06	1106 SERIES U-BRACKET FOR 1/2" THICK GLASS	\$132.00	
	1198/75-06	1106 SERIES U-BRACKET FOR 3/4" THICK GLASS	\$140.00	
	1198/50-10	1110/1120 U-BRACKET FOR 1/2" THICK GLASS DOOR	\$132.00	
	1198/75-10	1110/1120 U-BRACKET FOR 3/4" THICK GLASS DOOR	\$140.00	
	1198/50-15	1115 SERIES U-BRACKET FOR 1/2" THICK GLASS	\$100.00	
	1198/75-15	1115 SERIES U-BRACKET FOR 3/4" THICK GLASS	\$110.00	
	1198/50-50	1150&1000 SERIES U-BRACKET FOR 1/2" GLASS	\$150.00	
	1198/75-50	1150&1000 SERIES U-BRACKET FOR 3/4" GLASS	\$160.00	
	1198/50-55	1155 SERIES U-BRACKET FOR 1/2" THICK GLASS	\$110.00	
	1198/75-55	1155 SERIES U-BRACKET FOR 3/4" THICK GLASS	\$120.00	
		<b>(SUFFIX)</b>	<b><u>U-BRACKET SPECIAL FINISHES</u></b>	<b>(ADD)</b>
		xUS3	ADD FOR POLISHED BRASS	\$80.00
	xUS26	ADD FOR POLISHED CHROME	\$80.00	
	xUS4	ADD FOR SATIN BRASS	\$80.00	



# ELECTRIC STRIKES

<b>3300 SERIES</b>	<b>ELECTRIC STRIKES</b>	<u>PART #</u>	<u>DESCRIPTION</u>	<u>LIST PRICE</u>
--------------------	-------------------------	---------------	--------------------	-------------------



3300

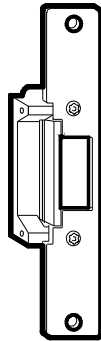

3300

3300xD

**STANDARD ANSI STRIKES**

12/24 DC ANSI STRIKE - FIELD SELECTABLE FAIL-SAFE/FAIL-SECURE FOR METAL DOOR FRAME

**\$155.00**

12/24 DC ANSI STRIKE WITH LATCH BOLT MONITOR SWITCH (SPDT) - FIELD SELECTABLE FAIL-SAFE/FAIL-SECURE FOR METAL DOOR FRAME

**\$225.00**

**WOOD FRAME STRIKE PLATE INCLUDED**

CONVERTS ANSI STYLE TO 9" TALL STRIKE FOR WOOD DOOR FRAME

**JAMB EXTENSION BRACKETS**

FOR USE WITH DEEP DOOR JAMB APPLICATIONS

3381

1 INCH JAMB EXTENSION BRACKET

**\$20.00**

3382

2 INCH JAMB EXTENSION BRACKET

**\$20.00**

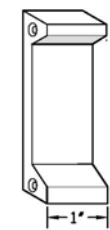

PART# -3381  
1" BRACKET

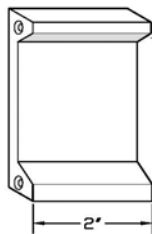



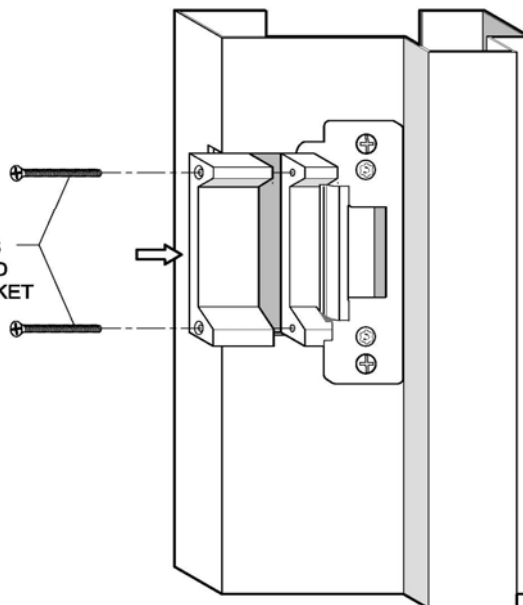

PART# - 3382  
2" BRACKET



SCREWS INCLUDED WITH BRACKET

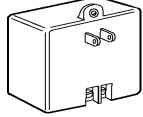
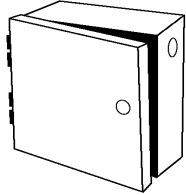
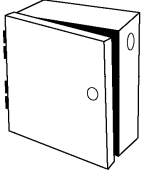

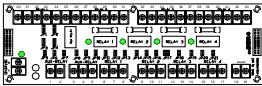
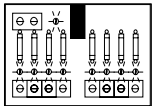
# POWER SUPPLIES

	<u>PART #</u>	<u>DESCRIPTION</u>	<u>LIST PRICE</u>
<b>4000 SERIES</b>	<b>PLUG-IN POWER SUPPLIES</b>		
	4012	<b><u>WALL MOUNT PLUG IN POWER SUPPLIES</u></b> 12 VOLT PLUG-IN POWER SUPPLY (1 AMP 12 VDC FOR USE WITH 1100 SERIES MAGLOCKS)	\$60.00
	4024	24 VOLT PLUG-IN POWER SUPPLY (1 AMP 24 VDC FOR USE WITH 1100 SERIES MAGLOCKS)	\$60.00
<b>4200 SERIES</b>	<b>POWER SUPPLIES</b>		
	<b><u>12/24 VDC POWER SUPPLIES</u></b>		
	4202	<b>2 AMP</b> POWER SUPPLY/CONTROLLER 12/24 VDC (FIELD SELECTABLE) w/ SWITCHING REGULATOR / FILTER / SURGE PROTECTION, BATTERY CHARGING CIRCUIT & FIRE ALARM RELAY FURNISHED IN 16" x 12" x 4" ELECTRICAL BOX - SEE SERIES 4200 OPTIONS	\$400.00
	4204	<b>4 AMP</b> POWER SUPPLY / CONTROLLER 12/24 VDC (FIELD SELECTABLE) SAME AS ABOVE	\$425.00
<b>4200 SERIES</b>	<b>POWER SUPPLY OPTIONS</b>		
	<b><u>4200 SERIES OPTIONS:</u></b>		
	<b>(SUFFIX)</b>	ADD FOR LARGER ENCLOSURES AS REQUIRED TO ACCOMMODATE MULTIPLE OPTIONS BELOW	<b>(ADD)</b>
	/1518	15" x 18" x 4" ENCLOSURE REQUIRED TO ACCOMMODATE MULTIPLE FUSED OUTPUT BOARDS OR RELAY MODULES	\$145.00
	/2024	20" x 24" x 5" ENCLOSURE REQUIRED TO ACCOMMODATE MULTIPLE FUSED OUTPUT BOARDS OR RELAY MODULES	\$275.00
	xBAT	12/24 VDC - 14 AMP HOUR BATTERY PACK INCLUDES 2 EACH 7 AH 12 VOLT RECHARGEABLE BATTERIES w/ HOOK-UP CABLES	\$112.00
	xRO	RELAY MODULE w/ FOUR (4) DPDT ISOLATION RELAYS (4-FUSED SPDT & 4-UNFUSED SPDT OUTPUTS) & 1 SPDT AUXILIARY RELAY 9" LONG X 3" WIDE	\$160.00
	xFO	8-ZONE FUSED OUTPUT BOARD (POWER DISTRIBUTION) 4-1/4" LONG X 3" WIDE	\$80.00
	xFO/AUX	8-ZONE FUSED OUTPUT BOARD (POWER DISTRIBUTION) w/ AUXILIARY POWER INTERRUPT RELAY 4-1/4" LONG X 3" WIDE	\$100.00
	xAO	ALARM RELAY OUTPUTS (AC POWER LOSS & LOW BATTERY ALERT)	\$40.00
	xAT	1-60 SECOND TIMER DPDT RELAY OUTPUT WITH '10 POSITION DOUBLE ROW TERMINAL 6 1/2" LONG	\$95.00
	xCT	ENCLOSURE COVER TAMPER SWITCH	\$44.00
	xPC	110 VAC GROUNDED POWER CORD 6'-0" LONG	\$14.00
	xTERM	10 POSITION DOUBLE ROW TERMINAL 6 1/2" LONG	\$24.00



# POWER SUPPLIES

<u>PART #</u>	<u>DESCRIPTION</u>	<u>LIST PRICE</u>
<b>4700 SERIES</b>	<b>PLC MANTRAPS &amp; INTERLOCKS</b>	

**ALL 4700 INTERLOCKS ARE FACTORY PRE-PROGRAMMED**

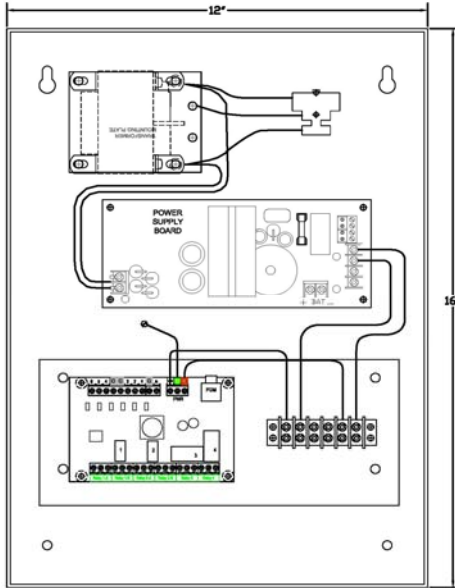

PLC BASED MULTI DOOR, INTERLOCK & MANTRAP CONTROLLERS ARE OFFERED IN STANDARD CONFIGURATIONS WHICH ALLOW FOR ONE DOOR STATUS AND ONE R-E-X INPUT PLUS ONE DPDT LOCK RELAY OUTPUT PER DOOR. A MAXIMUM OF 6-INPUTS AND 4-OUTPUTS CAPABILITY PLUS CUSTOM OPERATIONAL CHARACTERISTICS INCLUDING SEQUENCING AND TIMING MAY BE DESIGNED INTO THE UNIT UPON REQUEST.

A 4204 POWER SUPPLY INCLUDED IN THE NEMA ENCLOSURE PROVIDES 4 AMPS OF 12 or 24 VDC POWER FOR MAGLOCKS, STRIKES & LED's. A FIRE ALARM RELAY INPUT IS STANDARD. THE NUMBER OF LOCKS AND TOTAL CURRENT DRAW MAY REQUIRE ADDITIONAL POWER .

REQUEST MANTRAP / INTERLOCK CHECK LIST FROM FACTORY TO PROPERLY CONFIGURE 4700 PLC CONTROLLERS

### STANDARD CONFIGURATIONS

<b>47211-U</b>	<b>4700 SERIES 2 DOOR MANTRAP INTERLOCKS</b>	
<b>47211-LU</b>	2-Doors – 1-Room - All Doors Normally Unlocked	<b>\$1,150.00</b>
<b>47211-L</b>	2-Doors – 1-Room - 1-Door Locked & 1-Door Unlocked	
	2-Doors – 1-Room - All Doors Normally Locked	
<b>47311-U</b>	<b>4700 SERIES 3 DOOR MANTRAP INTERLOCKS</b>	
<b>47311-L2U</b>	3-Doors – 1-Room - All Doors Normally Unlocked	<b>\$1,200.00</b>
<b>47311-2LU</b>	3-Doors – 1-Room - 1-Locked & 2-Unlocked	
<b>47311-L</b>	3-Doors – 1-Room - 2-Locked - 1-Unlocked (No Lights)	
	3-Doors – 1-Room - 3-Locked (No Lights)	
<b>47411-U</b>	<b>4700 SERIES 4 DOOR MANTRAP INTERLOCKS</b>	
	4-Doors – 1-Room - All Doors Normally Unlocked	<b>\$1,300.00</b>
<b>(SUFFIX)</b>	<b>PROGRAMMABLE I.O. WITH NUMERIC DISPLAY</b>	<b>(ADD)</b>
	USER SELECTABLE MULTIFUNCTION PROGRAM	
<b>XDSP</b>	TIMER ALLOWS CUSTOM CONFIGURATION OF	
	INPUT/OUTPUT & TIMING FUNCTIONS	<b>\$350.00</b>
<b>47000-PRGM</b>	<b>CUSTOM CONFIGURATION PROGRAMMING</b>	
	FACTORY PROGRAMMING TO CUSTOM APPLICATION	<b>\$300/HR</b>
	SPECIFICATIONS	

*THE 4700 SERIES CONTROLLER IS LIMITED TO 6-INPUTS & 4-RELAY OUTPUTS TOTAL FOR DOOR LOCK & TRAFFIC LIGHT CONTROL.*

**SEE 4900 SERIES ON NEXT PAGE FOR MORE MANTRAP CONFIGURATIONS**



# POWER SUPPLIES

<b>PART #</b>	<b>DESCRIPTION</b>	<b>LIST PRICE</b>
<b>4900 SERIES</b>	<b>PLC MANTRAPS &amp; INTERLOCKS</b>	

**ALL 4900 INTERLOCKS ARE FACTORY PRE-PROGRAMMED**

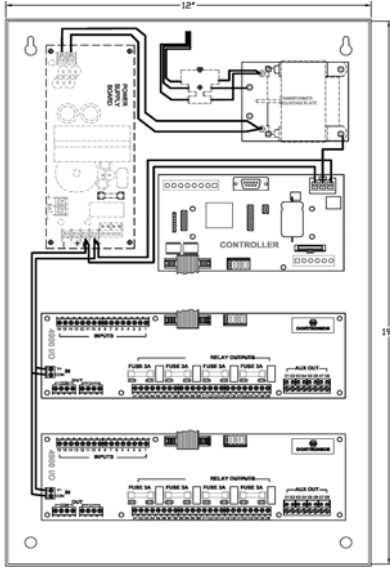

PLC BASED MULTI ROOM / MULTI DOOR, INTERLOCK & MANTRAP CONTROLLERS ARE OFFERED IN STANDARD CONFIGURATIONS WHICH ALLOW FOR ONE DOOR STATUS AND ONE R-E-X INPUT PLUS ONE DPDT LOCK RELAY OUTPUT PER DOOR. ADDITIONAL INPUT AND OUTPUT CAPABILITY PLUS CUSTOM OPERATIONAL CHARACTERISTICS INCLUDING SEQUENCING AND TIMING MAY BE DESIGNED INTO THE UNIT UPON REQUEST. **UP TO 120 TOTAL DOORS MAY BE CONFIGURED**

A 4204 POWER SUPPLY INCLUDED IN THE NEMA ENCLOSURE PROVIDES 4 AMPS OF 12 or 24 VDC POWER FOR MAGLOCKS, STRIKES & LED's. A FIRE ALARM RELAY INPUT IS STANDARD. DEPENDENT UPON THE NUMBER OF LOCKS AND TOTAL CURRENT DRAW, ADDITIONAL POWER MAY BE REQUIRED.

REQUEST MANTRAP / INTERLOCK CHECK LIST FROM FACTORY TO PROPERLY CONFIGURE 4900 PLC CONTROLLERS

### STANDARD CONFIGURATIONS

<b>49211-U</b>	<b>4900 SERIES 2 DOOR MANTRAP INTERLOCKS</b> 2-Doors – 1-Room - All Doors Normally Unlocked	<b>\$2,200.00</b>
<b>49211-L</b>	2-Doors – 1-Room - All Doors Normally Locked	
<b>49311-U</b>	<b>4900 SERIES 3 DOOR MANTRAP INTERLOCKS</b> 3-Doors – 1-Room - All Doors Normally Unlocked	<b>\$2,400.00</b>
<b>49311-L</b>	3-Doors – 1-Room - All Doors Normally Locked	
<b>49311-LU</b>	3-Doors – 1-Room - Doors Locked & Unlocked	
<b>49412-U</b>	<b>4900 SERIES 4 DOOR MANTRAP INTERLOCKS</b> 4-Doors – 1-Room - All Doors Normally Unlocked	<b>\$3,300.00</b>
<b>49412-L</b>	4-Doors – 1-Room - All Doors Normally Locked	
<b>49412-LU</b>	4-Doors – 1-Room - Doors Locked & Unlocked	

**\*\*\*MANY OTHER CONFIGURATIONS AVAILABLE CONTACT FACTORY\*\*\*  
OVER 4 DOORS & UP TO 120 DOORS CONTACT THE FACTORY FOR A QUOTE AS THESE WILL BE CUSTOM CONFIGURED TO YOUR SPECIFICATIONS**

<b>(SUFFIX)</b>	<b>PROGRAMMABLE I.O. WITH NUMERIC DISPLAY</b> USER SELECTABLE MULTIFUNCTION PROGRAM TIMER ALLOWS CUSTOM CONFIGURATION OF INPUT/OUTPUT & TIMING FUNCTIONS	<b>(ADD)</b> <b>\$475.00</b>
<b>XDSP</b>		
<b>49000-PRGM</b>	<b>CUSTOM CONFIGURATION PROGRAMMING</b> FACTORY PROGRAMMING TO CUSTOM APPLICATION SPECIFICATIONS	<b>\$300/HR</b>
<b>4900RLY</b>	<b>AUXILLIARY RELAY MODULE</b> ADDS 4 RELAY OUTPUTS TO ANY MANTRAP / INTERLOCK I/O BOARD FOR INDEPENDENT TRAFFIC LIGHT CONTROL OR ADDITIONAL CUSTOM FUNCTIONALITY	<b>\$110.00</b>

("DOORS" REFERS TO EACH OPENING WHICH MAY BE A PAIR OF DOORS)

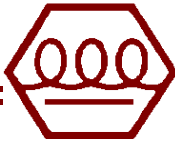

# ACTUATORS

## 5100 SERIES

### PART # DESCRIPTION

LIST PRICE

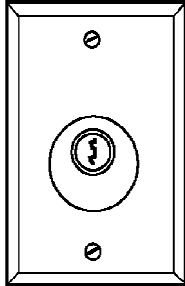

5141-25

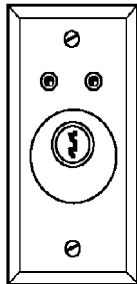

N5141-25XLXX

PART #	DESCRIPTION	LIST PRICE
<b>5141 SERIES KEY SWITCHES (LESS CYLINDER)</b>		
5141-23	FORM Z-DELAY ACTION KEY SWITCH ON SINGLE GANG PLATE (PNEUMATIC TIME DELAY)	\$260.00
5141-24	DPDT ALTERNATE ACTION KEY SWITCH ON SINGLE GANG PLATE	\$126.00
5141-25	DPDT MOMENTARY ACTION KEY SWITCH ON SINGLE GANG PLATE	\$114.00
5141-2/24	TWO POSITION KEY SWITCH ON SINGLE GANG PLATE w/ 2-DPDT MAINTAINED ACTION CONTACT SWITCHES	\$179.00
5141-2/25	TWO POSITION KEY SWITCH ON SINGLE GANG PLATE w/ 2-DPDT MOMENTARY ACTION CONTACT SWITCHES	\$155.00

(MOUNTING KIT INCLUDES CYLINDER NUT, PIN HEX SCREWS AND PIN HEX ALLEN WRENCH)

(SUFFIX)	5141 KEY SWITCH OPTIONS (ADD TO ABOVE):	(ADD)
xK	STANDARD 1-1/8" MORTISE CYLINDER & 2 KEYS	\$40.00
xKNR	CYLINDER WITH KEY NON-REMOVABLE IN "ON" POSITION	\$50.00
xP15	ADD SPDT PUSH BUTTON SWITCH	\$28.00
xCS	ADD DC PIEZO SOUNDER (REQUIRES 2-GANG PLATE)	\$68.00
xAT	1-60 SECOND TIMER DPDT RELAY OUTPUT (REQUIRES -25 MOMENTARY SWITCH)	\$60.00
xL	ADD 1 LED (BICOLOR RED / GREEN)	\$14.00
xCT	ADD 1 SPDT COVER TAMPER SWITCH	\$44.00

(SUFFIX)	5141 KEY SWITCH FINISHES	(ADD)
xUS26	POLISHED CHROME	\$40.00
xUS3	POLISHED BRASS FINISH	\$40.00
xUS4	SATIN BRASS FINISH	\$40.00
(PREFIX)		
N	WITH NARROW 1-3/4" SWITCH PLATE	\$6.00
D	WITH DOUBLE GANG SWITCH PLATE	\$12.00
HD	WITH HEAVY DUTY .060 THICK PLATE (1-GANG)	\$26.00
WR	WITH WEATHER RESISTANT SWITCH PLATE (1-GANG)	\$8.00

SEE #5240 SERIES & #7286 DOOR PROP ALARMS FOR OTHER KEY SWITCH CONFIGURATIONS

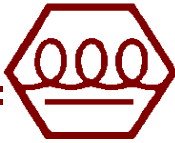

# ACTUATORS

## 5210 SERIES



5211-MP23XE1



5211-MP23KRXE2

### PART # DESCRIPTION LIST PRICE

## EXIT PUSH BUTTONS

PART #	DESCRIPTION	LIST PRICE
<b>5211 PUSH BUTTONS 1-9/16" DIA</b>		
5211-MP23/*	1-9/16" DIA. MUSHROOM PUSH BUTTON (SPECIFY CAP COLOR) w/ DPST MOMENTARY (1-NO & 1-NC CONTACT) MOUNTED ON SINGLE GANG PLATE	\$118.00
5211-MP24/*	1-9/16" DIA. MUSHROOM BUTTON (SPECIFY CAP COLOR) w/ DPST ALT ACTION (1-NO & 1-NC CONTACT) MOUNTED ON SINGLE GANG PLATE	\$134.00
5211-MP23PP/*	1-9/16" DIA. MUSHROOM PUSH-PULL BUTTON (RED CAP) w/ DPST ALT ACTION (1-NO & 1-NC CONTACT) MOUNTED ON SINGLE GANG PLATE	\$142.00
5211-LMP23	1-9/16" DIA. ILLUMINATED PUSH BUTTON (RED CAP) w/ DPST MOMENTARY ACTION (1-NO & 1-NC CONTACT) MOUNTED ON SINGLE GANG PLATE	\$130.00
5211-MP23DA/*	1-9/16"DIA. MUSHROOM PUSH BUTTON (SPECIFY CAP COLOR) w/PNEUMATIC 2-60 DELAY (FORM Z)	\$316.00
<b>5216 PALM BUTTONS 2-3/8" DIA</b>		
5216-MP23/*	2-3/8" DIA. PALM BUTTON (SPECIFY CAP COLOR) w/ DPST MOMENTARY (1-NO & 1-NC CONTACT)	\$130.00
5216-MP24/*	2-3/8" DIA. PALM BUTTON (SPECIFY CAP COLOR) w/ DPST ALT ACTION (1-NO & 1-NC CONTACT) MOUNTED ON SINGLE GANG PLATE	\$146.00
5216-MP23PP	2-3/8" DIA. PALM BUTTON (RED CAP) PUSH-PULL W/ DPST ALT ACTION (1-NO & 1-NC CONTACT)	\$152.00
5216-MP23DA/*	2-3/8" DIA. PALM BUTTON (SPECIFY CAP COLOR) W/ PNEUMATIC 2-60 SEC. DELAY (FORM Z)	\$326.00
<b>5211/16 LATCHING BUTTONS WITH KEY RESET</b>		
5211-MP23/KR	1-9/16" DIA. DURESS PUSH BUTTON (RED CAP) DPST LATCHING/ KEY RESET (1-NO & 1-NC CONTACT) ON SINGLE GANG PLATE	\$250.00
5216-MP23/KR	2-3/8" DIA. DURESS PUSH BUTTON (RED CAP) DPST LATCHING WITH KEY RESET (1-NO & 1-NC CONTACT) ON SINGLE GANG PLATE	\$262.00
5211-028L	28 VOLT LAMPS- PKG. OF 4	\$16.00

**(SUFFIX)**

/R	* DESIGNATES RED CAP	'N/C
/G	* DESIGNATES GREEN CAP (NON STOCK ITEM)	'N/C
/B	* DESIGNATES BLACK CAP	'N/C
/BU	* DESIGNATES BLUE CAP (NON STOCK ITEM)	\$10.00
-02CB	ADDITIONAL NO CONTACT BLOCK (Requires 2-3/4"	\$18.00
-03CB	ADDITIONAL NC CONTACT BLOCK deep back box)	\$18.00
xL	ADD 1 LED BLACK BEZEL (BI-COLOR RED/GREEN)	\$14.00
xAT	ADJUSTABLE 1-60 SEC. TIMER DPDT OUTPUT	\$60.00
xFT	FIXED 30 SECOND TIMER DPDT RELAY OUTPUT	\$60.00
XTS	TAMPER PROOF SCREWS & HEX KEY	\$12.00

**(SUFFIX)**

(SUFFIX)	ENGRAVING OPTIONS	(ADD)
xE1	S/S PLATE ENGRAVED "PUSH TO EXIT"	\$12.00
xE2	S/S PLATE ENGRAVED "PANIC"	\$12.00
xE3	S/S PLATE ENGRAVED "EMERGENCY RELEASE"	\$12.00
xE4	S/S PLATE ENGRAVED "PUSH TO RELEASE"	\$12.00
xE5	ENGRAVED "PULL TO RELEASE"	\$12.00
xE6	PER PLATE FEE AFTER SET UP	\$20.00
(ORDER AS LINE ITEM)----	XE6SETUP CUSTOM ENGRAVING 1 SET UP FEE PER RUN	\$60.00

**(PREFIX)**

(PREFIX)	5210 SERIES SWITCH PLATE OPTIONS	(ADD)
WR	WEATHER RESISTANT 1-GANG PLATE	\$8.00
D	DOUBLE GANG SWITCH PLATE	\$12.00
N	NARROW 1-3/4" PLATE FOR FRAME MOUNTING	\$6.00

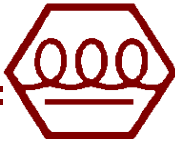

# ACTUATORS

## 5215 SERIES

### PART # DESCRIPTION

LIST PRICE

#### 5215 ILLUMINATED SQUARE PUSH BUTTONS



5215-SPBxE1

**5215-SPB** 1-1/2" ILLUMINATED SQUARE PUSH BUTTON (GREEN COLOR CAP ONLY) w/ SPDT MOMENTARY SWITCH CONTACTS MOUNTED ON SS SINGLE GANG PLATE LAMP BULBS ARE RATED @ 28VDC MAX **\$50.00**

**5215-SPBxE1** 1-1/2" ILLUMINATED SQUARE PUSH BUTTON "PUSH TO EXIT" LETTERING ON GREEN CAP w/ SPDT MOMENTARY SWITCH CONTACTS MOUNTED ON SS SINGLE GANG PLATE **\$54.00**

**5215-SPBxE3** 1-1/2" ILLUMINATED SQUARE PUSH BUTTON "EXIT" LETTERING ON GREEN CAP w/ SPDT MOMENTARY SWITCH CONTACTS MOUNTED ON SS SINGLE GANG PLATE **\$54.00**

**5215-SPBxL** 1-1/2" ILLUMINATED SQUARE PUSH BUTTON (GREEN CAP ONLY) w/ SPDT MOMENTARY SWITCH CONTACTS & BICOLOR LED MOUNTED ON SS SINGLE GANG PLATE **\$62.00**

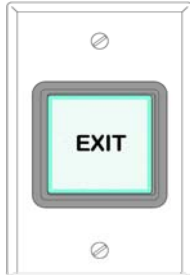

5215-SPBxLxE3

**5215-SPBxLxE1** 1-1/2" ILLUMINATED SQUARE PUSH BUTTON "PUSH TO EXIT" LETTERING ON GREEN CAP w/ SPDT MOMENTARY SWITCH CONTACTS & BICOLOR LED MOUNTED ON SS SINGLE GANG PLATE **\$66.00**

**5215-SPBxLxE3** 1-1/2" ILLUMINATED SQUARE PUSH BUTTON "EXIT" LETTERING ON GREEN CAP w/ SPDT MOMENTARY SWITCH CONTACTS & BICOLOR LED MOUNTED ON SS SINGLE GANG PLATE **\$66.00**

**5215-028L** 28 VOLT DC MAX REPLACEMENT LAMP **\$4.00**

<b>(SUFFIX)</b>		<b>(ADD)</b>
xAT	1-60 SECOND TIMER DPDT RELAY OUTPUT	<b>\$60.00</b>
xFT	FIXED 30 SECOND TIMER DPDT RELAY OUTPUT	<b>\$60.00</b>
xET	ADJUSTABLE 2 - 60 SEC. EXIT TIMER DPDT OUTPUT	<b>\$100.00</b>

#### SHOWN BELOW

5210/COV

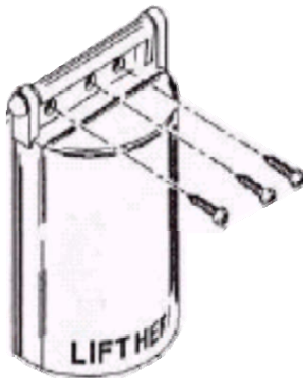

**5210/COV** ANTI TAMPER PLEXIGLAS BUTTON COVER PROTECTS PUSH BUTTON FROM BEING ACCIDENTALLY ACTUATED MOUNTS OVER SINGLE GANG SWITCH **\$55.00**

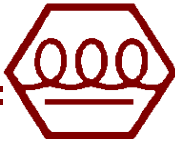

# ACTUATORS

## 5220 SERIES

### PART # DESCRIPTION LIST PRICE

## DELAYED ACTION PUSH BUTTONS

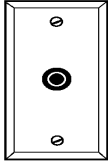

5221-P23DA

(ORDER AS LINE ITEM)----

5221-P23DA

(SUFFIX)

xUS3  
xUS4  
xL

xE1  
xE2  
xE3  
xE4  
xE6

XE6SETUP

(PREFIX)

N

### 5221 PNEUMATIC DELAY PUSH BUTTON

PNEUMATIC TIME DELAY PUSH BUTTON SWITCH

\$245.00

### 5221 TIME DELAY PUSH BUTTON OPTIONS

(ADD)

POLISHED BRASS PLATE

\$20.00

SATIN BRASS PLATE

\$20.00

ADD 1 LED BLACK BEZEL (BICOLOR RED / GREEN)

\$14.00

### ENGRAVING OPTIONS

S/S PLATE ENGRAVED "PUSH TO EXIT"

\$12.00

S/S PLATE ENGRAVED "PANIC"

\$12.00

S/S PLATE ENGRAVED "EMERGENCY RELEASE"

\$12.00

S/S PLATE ENGRAVED "PUSH TO RELEASE"

\$12.00

PER PLATE FEE AFTER SET UP

\$20.00

CUSTOM ENGRAVING 1 SET UP FEE PER RUN

\$60.00

### 5221 NARROW SWITCH PLATE OPTIONS

ADD NARROW 1-3/4" PLATE FOR FRAME MOUNTING

\$6.00

## 5230 SERIES

## SNAP ACTION PUSH BUTTONS



5231-P15

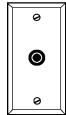

N5231-P15

5231-P15

5231-2P15

5231-3P15

(SUFFIX)

xL

(PREFIX)

N

D

### 5231 PUSH BUTTONS 3/8" DIAMETER

1 SPDT MOMENTARY PUSH BUTTON (1-GANG PLATE)

\$45.00

2 SPDT MOMENTARY PUSH BUTTON (1-GANG PLATE)

\$70.00

3 SPDT MOMENTARY PUSH BUTTON (1-GANG PLATE)

\$100.00

### ENGRAVING OPTIONS SAME AS 5221 ABOVE

### 5231 SWITCH OPTIONS (ADD):

(ADD)

ADD 1 LED BLACK BEZEL (BICOLOR RED / GREEN)

\$14.00

### 5231 NARROW SWITCH PLATE OPTIONS

ADD NARROW 1-3/4" PLATE FOR FRAME MOUNTING

\$6.00

ADD DOUBLE GANG SWITCH PLATE

\$12.00

## 5236 SERIES

## SNAP ACTION MINI BOX



5236-P15

### 5236 PUSH BUTTONS ON MINI-BOX CONSOLE

#### 2-1/2 LONG X 2 WIDE X 1" HIGH

5236-P14

1 SPDT MAINTAINED BUTTON MINI-BOX MOUNTED

\$86.00

5236-2P14

2 SPDT MAINTAINED BUTTONS MINI-BOX MOUNTED

\$110.00

5236-3P14

3 SPDT MAINTAINED BUTTONS MINI-BOX MOUNTED

\$138.00

5236-P15

1 SPDT MOMENTARY BUTTON MINI-BOX MOUNTED

\$86.00

5236-2P15

2 SPDT MOMENTARY BUTTONS MINI-BOX MOUNTED

\$110.00

5236-3P15

3 SPDT MOMENTARY BUTTONS MINI-BOX MOUNTED

\$138.00

5236-P24

1 DPDT MAINTAINED BUTTON MINI-BOX MOUNTED

\$116.00

5236-2P24

2 DPDT MAINTAINED BUTTONS MINI-BOX MOUNTED

\$170.00

5236-3P24

3 DPDT MAINTAINED BUTTONS MINI-BOX MOUNTED

\$228.00

5236-P25

1 DPDT MOMENTARY BUTTON MINI-BOX MOUNTED

\$111.00

5236-2P25

2 DPDT MOMENTARY BUTTONS MINI-BOX MOUNTED

\$160.00

5236-3P25

3 DPDT MOMENTARY BUTTONS MINI-BOX MOUNTED

\$213.00

5236-T24

1 DPDT MAINTAINED TOGGLE MINI-BOX MOUNTED

\$116.00

(SUFFIX)

xL

xL2

### SWITCH OPTIONS (ADD TO ABOVE):

(ADD)

ADD 1 LED (BICOLOR RED / GREEN) 2P-15 ONLY

\$14.00

ADD 2 LEDS (BICOLOR RED / GREEN) P-15 ONLY

\$22.00

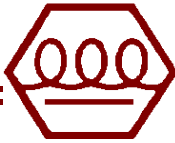

# ACTUATORS

## 5240 SERIES

### PART # DESCRIPTION LIST PRICE

## ELECTRICAL KEY SWITCH CONTROLS

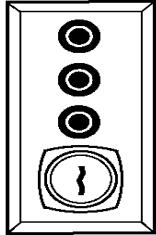

5241-K24x3P

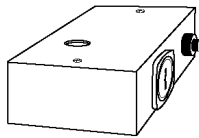

5246-K24xP15

### 5241 KEY SWITCHES ON SINGLE GANG PLATE

5241-K24	SPDT-MAINTAIN KEY REMOVABLE TWO POSITIONS	\$70.00
5241-K331	DPDT MAINT. KEY REMOVABLE IN ONE POSITION	\$110.00
5241-K332	DPDT MAINT. KEY REMOVABLE IN TWO POSITIONS	\$110.00
5241-K65-HS	SPDT-HIGH SECURITY KEY REMOVABLE 2 POSITIONS	\$178.00
5246000K	SPARE KEY SPECIFY K24 THRU K332	\$10.00
52400065	SPARE KEY SPECIFY K65-HS	\$34.00

### 5246 KEY SWITCH ON MINI-BOX CONSOLE 3-3/4 LONG X 2-1/2 WIDE X 1-1/2" HIGH

5246-K24	SPDT KEY SWITCH KEY REMOVABLE IN TWO POSITIONS ADD PUSH BUTTONS BELOW AS REQUIRED (3/8" DIA)	\$125.00
5246-2K24	DUAL SPDT KEY SWITCHES KEY REMOVABLE IN TWO POSITIONS ADD MAX 2 PUSH BUTTONS BELOW AS REQUIRED (3/8" DIA)	\$175.00
5246-K331	DPDT KEY SWITCH KEY REMOVABLE IN ONE POSITION ADD PUSH BUTTONS BELOW AS REQUIRED (3/8" DIA)	\$205.00
5246-K332	DPDT KEY SWITCH KEY REMOVABLE IN TWO POSITIONS ADD PUSH BUTTONS BELOW AS REQUIRED (3/8" DIA)	\$205.00
5246-K65-HS	SPDT HIGH SECURITY KEY SWITCH KEY REMOVABLE IN ONE POSITION ADD PUSH BUTTONS BELOW AS REQUIRED (3/8" DIA)	\$225.00

### (SUFFIX) 5246 SWITCH OPTIONS (ADD TO ABOVE) (ADD)

ANY COMBINATION OF 4 LED's OR PUSH BUTTONS MAY BE COMBINED w/ 1 KEY SWITCH

#### LEDS

xL	ADD 1 LED BLACK BEZEL (BICOLOR RED / GREEN)	\$14.00
xL2	ADD 2 LEDS BLACK BEZEL (BICOLOR RED / GREEN)	\$22.00
xL3	ADD 3 LEDS BLACK BEZEL (BICOLOR RED / GREEN)	\$30.00

#### SPDT MAINTAINED BUTTONS

xP14	ADD ONE SPDT MAINTAINED BUTTON	\$25.00
x2P14	ADD TWO SPDT MAINTAINED BUTTONS	\$50.00
x3P14	ADD THREE SPDT MAINTAINED BUTTONS	\$75.00
x4P14	ADD FOUR SPDT MAINTAINED BUTTONS	\$100.00

#### SPDT MOMENTARY BUTTONS

xP15	ADD ONE SPDT MOM PUSH BUTTON	\$25.00
x2P15	ADD TWO SPDT MOM PUSH BUTTONS	\$50.00
x3P15	ADD THREE SPDT MOM PUSH BUTTONS	\$75.00
x4P15	ADD FOUR SPDT MOM PUSH BUTTONS	\$100.00

#### DPDT MOMENTARY BUTTONS

xP25	ADD ONE DPDT MOMENTARY BUTTON	\$50.00
x2P25	ADD TWO DPDT MOMENTARY BUTTONS	\$100.00
x3P25	ADD THREE DPDT MOMENTARY BUTTONS	\$150.00
x4P25	ADD FOUR DPDT MOMENTARY BUTTONS	\$200.00

#### DPDT MAINTAINED BUTTONS

xP24	ADD ONE DPDT MAINTAINED BUTTON	\$55.00
x2P24	ADD TWO DPDT MAINTAINED BUTTONS	\$110.00
x3P24	ADD THREE DPDT MAINTAINED BUTTONS	\$165.00
x4P24	ADD FOUR DPDT MAINTAINED BUTTONS	\$220.00

#### SPNO PIEZO ELECTRIC TOUCH BUTTON

xPZ15	ADD ONE SPNO PIEZO ELECTRIC TOUCH BUTTON	\$85.00
x2PZ15	ADD TWO SPNO PIEZO ELECTRIC TOUCH BUTTONS	\$170.00
x3PZ15	ADD THREE SPNO PIEZO ELECTRIC TOUCH BUTTON	\$255.00

(ONLY 3 PZ15 BUTTONS WILL FIT ON THE 5246 UNIT WITH A KEY SWITCH)

T24	1 DPDT MAINTAINED TOGGLE	\$55.00
-----	--------------------------	---------

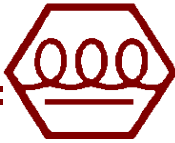

# ACTUATORS

## 5260 SERIES

PART #	DESCRIPTION	LIST PRICE
--------	-------------	------------

### 3/4" SQUARE PUSH BUTTONS

#### SINGLE GANG 5260 3/4" SQUARE BUTTONS

5260-25/*	3/4" SQUARE PUSH BUTTON (SPECIFY CAP COLOR) w/ DPST MOMENTARY (1-NO & 1-NC CONTACT) MOUNTED ON SINGLE GANG SS PLATE	\$64.00
-----------	---	---------



5260-25/GxE1

5260-24/*	3/4" SQUARE PUSH BUTTON (SPECIFY CAP COLOR) w/ DPST MAINTAINED (1-NO & 1-NC CONTACT) MOUNTED ON SINGLE GANG SS PLATE	\$64.00
-----------	--	---------

#### ILLUMINATED 5260 3/4" SQUARE BUTTONS

5260-LMP25/*	3/4" SQUARE ILLUMINATED BUTTON (SPECIFY CAP COLOR) w/ DPST MOMENTARY (1-NO & 1-NC CONTACT) MOUNTED ON SINGLE GANG SS PLATE	\$82.00
--------------	--	---------

5260-LMP24/*	3/4" SQUARE ILLUMINATED BUTTON (SPECIFY CAP COLOR) w/ DPST MAINTAINED (1-NO & 1-NC CONTACT) MOUNTED ON SINGLE GANG SS PLATE	\$82.00
--------------	---	---------

#### NARROW PLATE 5260 3/4" SQUARE BUTTONS

N5260-25/*	3/4" SQUARE PUSH BUTTON (SPECIFY CAP COLOR) w/ DPST MOMENTARY (1-NO & 1-NC CONTACT) MOUNTED ON NARROW 1-3/4" SS PLATE	\$70.00
------------	---	---------

N5260-24/*	3/4" SQUARE PUSH BUTTON (SPECIFY CAP COLOR) w/ DPST MAINTAINED (1-NO & 1-NC CONTACT) MOUNTED ON NARROW 1-3/4" SS PLATE	\$70.00
------------	--	---------

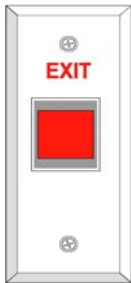

N5260-25/RxE3

#### NARROW ILLUMINATED 5260 3/4" BUTTONS

N5260-LMP25/*	3/4" SQUARE ILLUMINATED BUTTON (SPECIFY CAP COLOR) w/ DPST MOMENTARY (1-NO & 1-NC CONTACT) MOUNTED ON NARROW 1-3/4" SS PLATE	\$88.00
---------------	--	---------

N5260-LMP24/*	3/4" SQUARE ILLUMINATED BUTTON (SPECIFY CAP COLOR) w/ DPST MAINTAINED (1-NO & 1-NC CONTACT) MOUNTED ON NARROW 1-3/4" SS PLATE	\$88.00
---------------	---	---------

(SUFFIX)		(ADD)
xAT	1-60 SECOND TIMER DPDT RELAY OUTPUT	\$60.00
xFT	FIXED 30 SECOND TIMER DPDT RELAY OUTPUT	\$60.00

5210/COV  
SHOWN BELOW

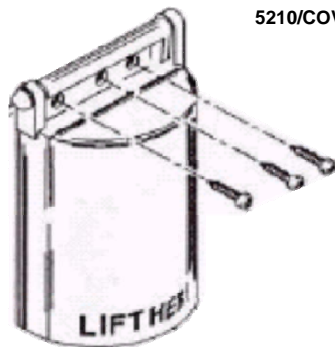

5210/COV	<u>ANTI TAMPER PLEXIGLAS BUTTON COVER</u> PROTECTS PUSH BUTTON FROM BEING ACCIDENTALLY ACTUATED MOUNTS OVER SINGLE GANG SWITCH	\$55.00
----------	---	---------

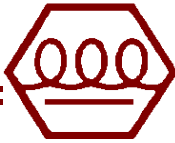

# ACTUATORS

## 5276 SERIES

### PART # DESCRIPTION

LIST PRICE



5276-MP9/BxE1



N5276-HD28xE2

5276-MP8/*	ALTERNATE ACTION PUSH BUTTON SWITCH DPST MOUNTED ON STANDARD S/S SINGLE GANG PLATE	\$148.00
5276-MP9/*	MOMENTARY ACTION PUSH BUTTON SWITCH DPST MOUNTED ON STANDARD S/S SINGLE GANG PLATE	\$85.00

### 5276 SERIES 1" DIAMETER PUSH BUTTONS

### 5276-G SERIES 1" GUARDED PUSH BUTTONS

5276-GP8/*	ALTERNATE ACTION PUSH BUTTON SWITCH DPST GUARD MOUNTED ON SINGLE GANG PLATE	\$150.00
5276-GP9/*	MOMENTARY ACTION PUSH BUTTON SWITCH DPST GUARD MOUNTED ON SINGLE GANG PLATE	\$90.00

### 5276 SERIES HEAVY DUTY PUSH BUTTONS

5276-HD28	HEAVY DUTY (VANDAL RESISTANT) 1" STEEL PUSH BUTTONS <b>ALTERNATE ACTION (DPDT)</b> SWITCH MOUNTED ON STANDARD S/S SINGLE GANG PLATE	\$158.00
5276-HD29	HEAVY DUTY (VANDAL RESISTANT) 1" STEEL PUSH BUTTONS <b>MOMENTARY (DPDT)</b> SWITCH MOUNTED ON STANDARD S/S SINGLE GANG PLATE	\$150.00

<u>(SUFFIX)</u>	<u>5276 SERIES OPTIONS ADD TO ABOVE</u>	<u>(ADD)</u>
xAT	ADJUSTABLE 1 - 60 SEC. TIMER DPDT OUTPUT	\$60.00
xFT	FIXED 30 SECOND TIMER DPDT RELAY OUTPUT	\$60.00
xET	ADJUSTABLE 2 - 60 SEC. EXIT TIMER DPDT OUTPUT	\$100.00
xL	ADD 1 LED BLACK BEZEL (BICOLOR RED / GREEN)	\$14.00
xL	(FOR HEAVY DUTY xHD SERIES CHROME BEZEL)	\$20.00
<u>(PREFIX)</u>		
N	NARROW 1-3/4" PLATE	\$6.00

<u>(SUFFIX)</u>	<u>AVAILABLE ON 5276-MP &amp; GP SERIES ONLY</u>	
/R	* DESIGNATES RED BUTTON CAP	N/C
/B	* DESIGNATES BLACK BUTTON CAP	N/C
/G	* DESIGNATES GREEN BUTTON CAP (NON STOCK)	N/C
-MP23DA	PNEUMATIC 2-60 SEC. TIME DELAY SWITCH	\$200.00
-GP23DA	PNEUMATIC 2-60 SEC. TIME DELAY SWITCH	\$200.00
-HD23DA	PNEUMATIC 2-60 SEC. TIME DELAY SWITCH	\$200.00

<u>(SUFFIX)</u>	<u>ENGRAVING OPTIONS</u>	
xE1	PLATE ENGRAVED "PUSH TO EXIT"	\$12.00
xE2	PLATE ENGRAVED "PANIC"	\$12.00
xE3	PLATE ENGRAVED "EMERGENCY RELEASE"	\$12.00
xE4	PLATE ENGRAVED "PUSH TO RELEASE"	\$12.00
xE6	PER PLATE FEE AFTER SET UP	\$20.00
(ORDER AS LINE ITEM)---- XE6SETUP	CUSTOM ENGRAVING 1 SET UP FEE PER RUN	\$60.00

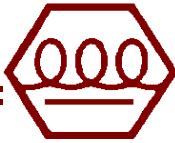

# ACTUATORS

**5277 SERIES PIEZO ELECTRIC SWITCHES**

PART #

DESCRIPTION

LIST PRICE

**5277 SERIES PIEZO ELECTRIC SWITCHES**

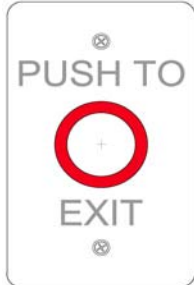

W5277-PZLXE1

**W5277-PZL**

TIME DELAY (1-40 SECOND) PIEZO SWITCH  
1 SET N.O. 1 SET N.C. CONTACTS WITH ILLUMINATED  
BI COLOR LED RING MOUNTED ON STANDARD  
STAINLESS STEEL 1 GANG PLATE COMPLETELY  
SEALED FOR WEATHER RESISTANCE

**\$275.00**



N5277-PZLXE3

**N5277-PZL**

TIME DELAY (1-40 SECOND) PIEZO SWITCH  
1 SET N.O. 1 SET N.C. CONTACTS WITH ILLUMINATED  
BI COLOR LED RING MOUNTED ON NARROW 1-3/4"  
STAINLESS STEEL PLATE COMPLETELY SEALED FOR  
WEATHER RESISTANCE

**\$275.00**

**(SUFFIX)**

**5277 STOCK ENGRAVING (ADD)**

**(ADD)**

**xE1**

ADD "PUSH TO EXIT" IN RED LETTERS

**\$20.00**

**xE3**

ADD "EXIT" IN RED LETTERS

**\$20.00**

**5277 CUSTOM ENGRAVING (ADD)**

**xE6**

PER PLATE FEE AFTER SET UP

**\$20.00**

**(ORDER AS LINE ITEM)---- XE6SETUP**

CUSTOM ENGRAVING 1 SET UP FEE PER RUN

**\$60.00**

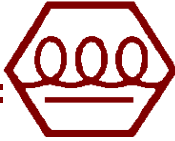

# ACTUATORS

## 5286 SERIES

### PART # DESCRIPTION

LIST PRICE

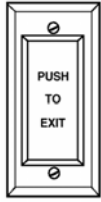

N5286-P25xE1

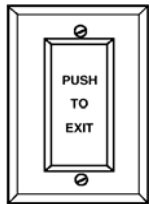

W5286-P25xE1

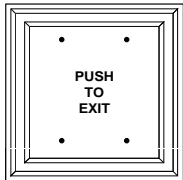

D5286-P25xE1

### NARROW STYLE PUSH PLATE SWITCHES

N5286-P24	DPDT MAINTAINED ACTION SWITCH WITH 1-1/2" WIDE PUSH PLATE ON 1-3/4" ALUMINUM BACK PLATE	\$114.00
N5286-P25	DPDT MOMENTARY ACTION SWITCH WITH 1-1/2" WIDE PUSH PLATE ON 1-3/4" ALUMINUM BACK PLATE	\$100.00
N5286-P23DA	PNEUMATIC 2-60 SECOND DELAY (FORM Z) SWITCH WITH 1-1/2" WIDE PUSH PLATE ON 1-3/4" ALUMINUM BACK PLATE	\$312.00
N5286-AT	ADJUSTABLE 2-60 SECOND TIMER DPDT OUTPUT	\$146.00
N5286-FT	FIXED 30 SECOND TIMER DPDT RELAY OUTPUT	\$146.00
N5286-ET	ADJUSTABLE 2-60 SEC. EXIT TIMER DPDT OUTPUT	\$186.00

### SINGLE GANG PUSH PLATE SWITCHES

W5286-P24	DPDT MAINTAINED ACTION SWITCH WITH 1-1/2" WIDE PUSH PLATE ON 3" WIDE ALUMINUM BACK PLATE	\$114.00
W5286-P25	DPDT MOMENTARY ACTION SWITCH WITH 1-1/2" WIDE PUSH PLATE ON 3" WIDE ALUMINUM BACK PLATE	\$100.00
W5286-P23DA	PNEUMATIC 2-60 SEC. DELAY (FORM Z) SWITCH WITH 1-1/2" WIDE PUSH PLATE ON 3" WIDE BACK PLATE	\$312.00
W5286-AT	ADJUSTABLE 2-60 SECOND TIMER DPDT OUTPUT	\$146.00
W5286-FT	FIXED 30 SECOND TIMER DPDT RELAY OUTPUT	\$146.00
W5286-ET	ADJUSTABLE 2-60 SEC. EXIT TIMER DPDT OUTPUT	\$186.00

### DOUBLE GANG PUSH PLATE SWITCHES

D5286-P24	DPDT MAINTAINED ACTION SWITCH WITH 4" WIDE PUSH PLATE ON 4-5/8" WIDE ALUMINUM BACK PLATE	\$138.00
D5286-P25	DPDT MOMENTARY ACTION SWITCH WITH 4" WIDE PUSH PLATE ON 4-5/8" WIDE ALUMINUM BACK PLATE	\$126.00
D5286-P23DA	PNEUMATIC 2 - 60 SEC. DELAY (FORM Z) SWITCH WITH 4" PUSH PLATE ON 4-5/8" WIDE BACK PLATE	\$326.00
D5286-AT	ADJUSTABLE 2-60 SECOND TIMER DPDT OUTPUT	\$170.00
D5286-FT	FIXED 30 SECOND TIMER DPDT RELAY OUTPUT	\$170.00
D5286-ET	ADJUSTABLE 2-60 SEC. EXIT TIMER DPDT OUTPUT	\$210.00
<u>(SUFFIX)</u>		<u>(ADD)</u>
xL	ADD 1 LED BLACK BEZEL (BICOLOR RED / GREEN) RECESSED INTO PUSH PAD (NOT AVAILABLE ON "D" SERIES)	\$28.00

\*\*\*\*\* PLEASE SEE PAGE 24 FOR ENGRAVING OPTIONS\*\*\*\*\*



# ACTUATORS

## 5286 SERIES

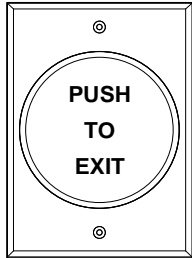

<u>PART #</u>	<u>DESCRIPTION</u>	<u>LIST PRICE</u>
<b>ROUND PUSH PLATE SWITCHES</b>		
<u>ROUND PUSH PLATE SWITCHES</u>		
R5286-P24	DPDT MAINTAINED ACTION SWITCH WITH 2-1/2" ROUND PALM BUTTON ON 3" WIDE ALUMINUM BACK PLATE	\$120.00
R5286-P25	DPDT MOMENTARY ACTION SWITCH WITH 2-1/2" ROUND PALM BUTTON ON 3" WIDE ALUMINUM BACK PLATE	\$108.00
R5286-P23DA	PNEUMATIC 2-60 SECOND DELAY (FORM Z) SWITCH WITH 2-1/2" ROUND PALM BUTTON ON 3" WIDE ALUMINUM BACK PLATE	\$312.00
R5286-AT	ADJUSTABLE 2-60 SECOND TIMER DPDT OUTPUT	\$156.00
R5286-FT	FIXED 30 SECOND TIMER DPDT RELAY OUTPUT	\$156.00
R5286-ET	ADJUSTABLE 2-60 SEC. EXIT TIMER DPDT OUTPUT	\$210.00
<u>(SUFFIX)</u>		<u>(ADD)</u>
xL	ADD 1 LED BLACK BEZEL (BICOLOR RED / GREEN)	\$14.00

\*\*\*\*\* PLEASE SEE PAGE 25 FOR ENGRAVING OPTIONS\*\*\*\*\*

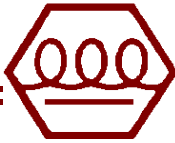

# ACTUATORS

## 5286 SERIES

### PART #                      DESCRIPTION **CUSTOM FINISHES & ENGRAVING**

### LIST PRICE

#### 5286 STOCK ENGRAVING (ADD)

<u>(SUFFIX)</u>		<u>(ADD)</u>
xE1	ADD "PUSH TO EXIT" IN BLACK LETTERS	\$12.00
xE1R	ADD "PUSH TO EXIT" IN RED LETTERS	\$12.00
xE2	ADD "PANIC" IN RED LETTERS	\$12.00
xE3	ADD "EXIT" IN RED LETTERS	\$8.00
xE4	ADD "DOOR RELEASE" IN BLACK LETTERS	\$12.00
xE5	ADD "EMERGENCY DOOR RELEASE" IN RED LETTERS	\$18.00
xE6	PER PLATE FEE AFTER SET UP	\$20.00
(ORDER AS LINE ITEM)---- XE6SETUP	CUSTOM ENGRAVING 1 SET UP FEE PER RUN	\$60.00

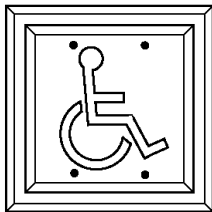

D5286-P25xHCP

<u>(SUFFIX)</u>	<u>5286 STANDARD HANDICAP LOGOS</u>	<u>(ADD)</u>
xHCP	ADD FOR BLUE LOGO ON CLEAR ALUMINUM ONLY	\$32.00
xHCP2	ADD FOR BLUE LOGO W/ "PUSH TO OPEN" ON CLEAR ALUMINUM	\$44.00
xHCP3	ADD FOR WHITE LOGO ON BLUE ENAMEL PLATE W / "PUSH TO OPEN" (D-SERIES ONLY)	\$80.00

**ENGRAVING ON RED, BLACK & DARK BRONZE PUSH PLATES WILL BE WHITE**

<u>(SUFFIX)</u>	<u>5286 SERIES FINISH OPTIONS</u>	<u>(ADD)</u>
xBRE	ADD FOR BAKED RED ENAMEL FINISH (NON-STOCK)	\$22.00
xDBA	ADD FOR DARK BRONZE ANODIZED (STOCKED)	\$22.00
xSBA	ADD FOR SATIN BLACK ANODIZED (NON-STOCK) (IF BUTTON IS XBRE XSBA OR XDBA TEXT IS WHITE)	\$22.00
xUS26	ADD FOR POLISHED CHROME -	
xUS26D	ADD FOR SATIN CHROME -	
xUS3	ADD FOR POLISHED BRASS -	
xUS4	ADD FOR SATIN BRASS -	
	ALL PLATED FINISHES - (N,W & R SERIES)	\$75.00
	ALL PLATED FINISHES - (D SERIES)	\$95.00



# ACTUATORS

## 5287 SERIES

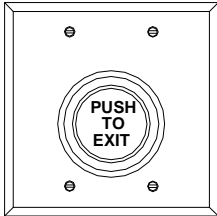
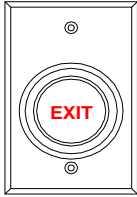

D5287xE1

(ORDER AS LINE ITEM)----

PART #	DESCRIPTION	LIST PRICE
<b>HEAVY DUTY PUSH BUTTON SWITCHES</b>		
<b><u>SINGLE GANG PUSH BUTTON SWITCHES</u></b>		
W5287-P24	DPDT MAINTAINED ACTION SWITCH WITH 1-1/2" DIAMETER BUTTON ON ALUMINUM BACK PLATE	\$140.00
W5287-P25	DPDT MOMENTARY ACTION SWITCH WITH 1-1/2" DIAMETER BUTTON ON ALUMINUM BACK PLATE	\$128.00
W5287-P23DA	PNEUMATIC 2 - 60 SEC. DELAY (FORM Z) SWITCH WITH 1-1/2" DIAMETER BUTTON ON ALUMINUM BACK PLATE	\$341.00
W5287-AT	ADJUSTABLE 1 - 60 SECOND TIMER DPDT OUTPUT WITH 1-1/2" DIAMETER BUTTON ON ALUMINUM BACK PLATE	\$175.00
W5287-FT	FIXED 30 SECOND TIMER DPDT OUTPUT WITH 1-1/2" DIAMETER BUTTON ON 3" WIDE ALUMINUM BACK PLATE	\$175.00
W5287-ET	ADJUSTABLE 1 - 60 SECOND EXIT TIMER DPDT OUTPUT WITH 1-1/2" DIAMETER BUTTON ON ALUMINUM BACK PLATE	\$210.00
<b><u>DOUBLE GANG PUSH PLATE SWITCHES</u></b>		
D5287-	CHANGE "W" TO "D" TO SPECIFY A DOUBLE GANG 4-5/8" WIDE ALUMINUM BACK PLATE WITH 1-1/2" DIAMETER BUTTON	(ADD) \$40.00
(SUFFIX)	<b><u>5287 STOCK ENGRAVING (ADD):</u></b>	(ADD)
xE1	ADD "PUSH TO EXIT" IN BLACK LETTERS	\$12.00
xE1R	ADD "PUSH TO EXIT" IN RED LETTERS	\$12.00
xE3	ADD "EXIT" IN RED LETTERS	\$8.00
xE6	PER PLATE FEE AFTER SET UP	\$20.00
XE6SETUP	CUSTOM ENGRAVING 1 SET UP FEE PER RUN	\$60.00
<b><u>5287 STANDARD HANDICAP LOGOS</u></b>		
xHCP	ADD HANDICAP BLUE LOGO ON CLEAR ALUMINUM	\$32.00
xHCP3	ADD HANDICAP WHITE LOGO ON BLUE ALUMINUM	\$32.00
(SUFFIX)	<b><u>5287 SERIES FINISH OPTIONS</u></b>	(ADD)
xDBA	ADD FOR DARK BRONZE ANODIZED	\$22.00
xSBA	ADD FOR SATIN BLACK ANODIZED (NON-STOCKED)	\$22.00
xBRE	ANODIZED RED FINISH (ON BUTTON ONLY) BACK PLATE CLEAR ANODIZED OR PLATED FINISH (IF BUTTON IS XBRE XSBA OR XDBA TEXT IS WHITE)	\$22.00
xUS26	ADD FOR POLISHED CHROME -	
xUS26D	ADD FOR SATIN CHROME -	
xUS3	ADD FOR POLISHED BRASS -	
xUS4	ADD FOR SATIN BRASS -	
	ALL PLATED FINISHES - (N,W & R SERIES)	\$75.00
	ALL PLATED FINISHES - (D SERIES)	\$95.00
(SUFFIX)		(ADD)
xL	ADD 1 LED (BICOLOR RED / GREEN) CHROME BEZEL FOR HEAVY DUTY SERIES	\$20.00



# ACCESSORIES

6200 SERIES	PART #	DESCRIPTION	LIST PRICE
	<b>DOOR CORD</b>		
		<b>6200 SERIES DOOR CORD</b>	
	6220	18" ARMORED DOOR CORD WITH SURFACE MOUNT J-BOX 1-5/8" WIDE x 3" LONG x 1-1/8" DEEP (INCLUDES 4 CONDUCTOR 22 AWG CABLE) STANDARD COLOR ALUMINUM	\$50.00
	(SUFFIX)	<b>ARMORED DOOR CORD FINISHES (ADD):</b>	
	xDBA	ADD FOR DARK BRONZE COLORED CORD AND J-BOX ARMORED DOOR CORD	N/C

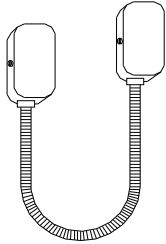

A DOOR CORD IS TYPICALLY REQUIRED TO TRANSFER POWER TO AN EGRESS BAR

## 6400 SERIES EGRESS BARS



		<b>6400 SERIES EGRESS SWITCH BARS</b>	
	6420-S25	EGRESS BAR FOR 36" DOOR WITH DUAL SPDT SWITCHES STANDARD ALUMINUM FINISH	\$365.00
	6495	RIM STYLE MECHANICAL LATCHING FOR 36" DOOR UL LISTED PANIC DEVICE (NO SWITCH)	\$315.00
	6495-S25	RIM STYLE MECHANICAL LATCHING FOR 36" DOOR PANIC DEVICE WITH 2 SPDT SWITCHES	\$390.00
	(SUFFIX)	<b>WEATHERPROOF SWITCHES</b>	(ADD)
	xWR	DUAL SEALED WEATHERPROOF SPDT SWITCHES FOR OUTDOOR APPLICATIONS	\$70.00
	(SUFFIX)	<b>EGRESS BAR SPECIAL FINISHES:</b>	(ADD)
	xDBA	ADD FOR DARK BRONZE ANODIZED FINISH	\$16.00
	X48	ADD FOR DOORS OVER 36" UP TO 48" (NON STOCK)	\$25.00



# ACCESSORIES

## 6500 SERIES

### PART #                      DESCRIPTION

## EMERGENCY PULL STATIONS

LIST PRICE

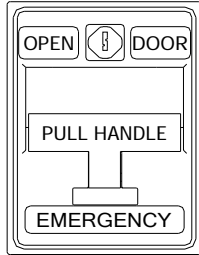

### 6500 SERIES EMERGENCY PULL STATIONS

6510/*-S35	PULL STATION W/ TWO SPDT (FORM C) SWITCHES	\$175.00
6510/*-S35xCS	PULL STATION W/ TWO SPDT (FORM C) SWITCHES WITH LOCAL PIEZO 12-24VDC	\$205.00

**\* SPECIFY COLOR:**

- /BL = BLUE ENAMEL FINISH
- /BK = BLACK ENAMEL FINISH
- /YL = YELLOW ENAMEL FINISH

(SUFFIX)

ACCESSORIES

(ADD)

(ORDER AS LINE ITEM)---- XE6SETUP

XE6	CUSTOM LABELING SETUP PER UNIT FEE AFTER SET UP	\$60.00 \$20.00
651000K	SPARE KEY	\$10.00
6510/BR	BREAK RODS 12 PER PACK	\$24.00
6510/COV	PLEXIGLASS ANTI TAMPER COVER 5" X 1-1/2" X 5-1/2" LIFT TO ACCESS PULL	\$95.00
6510/COV/S	SAME AS ABOVE WITH PIEZO ALARM SOUNDER	\$230.00
6510/COV/SR	ANTI-TAMPER COVER W/SOUNDER & SPDT RELAY	\$250.00

SURFACE MOUNT COLORED BACK BOXES

6510/BX-BK	BLACK SURFACE MOUNT BACK BOX	\$44.00
6510/BX-BL	BLUE SURFACE MOUNT BACK BOX	\$44.00
6510/BX-YL	YELLOW SURFACE MOUNT BACK BOX	\$44.00

## 6600 SERIES

### MOTION DETECTORS

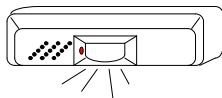

6612	UL LISTED REQUEST-TO-EXIT PIR MOTION DETECTOR (12/24 VDC) w/ ADJUSTABLE (1-120 SECOND) TIME DELAY IN A SLIM LINE 7.1" x 1.65" x 1.65" IVORY COLORED CASE (ONE DPDT FORM C ALARM OUTPUT)	\$212.00
------	--	----------



# ANNUNCIATORS

	<u>PART #</u>	<u>DESCRIPTION</u>	<u>LIST PRICE</u>
<b>7101 SERIES</b>	<b>DELAYED EGRESS CONTROLLERS</b>		

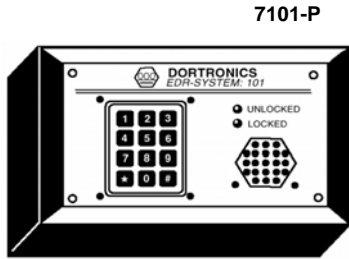

7101-P

**EDR SYSTEM-101 CONTROLLER**

**EDR-101 DELAYED EGRESS CONTROL PANEL**  
 KEYPAD CONSOLE, AUDIBLE ALERT, 3 SECOND NUISANCE / 15 SECOND ALARM DELAY, PROGRAMMABLE CLOCK / DAY SCHEDULER, 3 STATUS OUTPUTS, PROGRAMMABLE ESCORT CODE FOR KEYPAD (OR OPTIONAL KEY SWITCH) INCLUDES 12 VDC 1 AMP POWER SUPPLY, 9 VDC 0.2 AMP POWER SUPPLY, WITH 9 VOLT RECHARGEABLE BATTERY, 3 GANG S/S FLUSH MOUNT PLATE, 3 GANG (IVORY) SURFACE MOUNT BOX, AND 20 FOOT LONG HOOK-UP CABLES

**\$960.00**

**EDR SYSTEM-101 ACCESSORIES:**



7101-KP

**AUXILIARY KEYPAD** - SUPPLIED WITH 15 FOOT CABLE, WEATHER RESISTANT FOR AUTHORIZED ACCESS FROM SECURED SIDE

**\$264.00**



5141-24xK

DPDT MAINTAINED KEY SWITCH - EDR-101 ALARM SHUNT / BY-PASS SEE PAGE 15 FOR DETAILED DESCRIPTION

**\$166.00**



5216-MP23xE3

PUSH BUTTON SWITCH - EMERGENCY RELEASE SEE PAGE 17 FOR DETAILED DESCRIPTION

**\$142.00**



6420-S25

**EGRESS BAR w/ TWO SPDT SWITCHES**  
 (ACTIVATES EDR-101 & HAS 1 EXTRA OUTPUT) SEE PAGE 26 FOR DETAILS

**\$365.00**

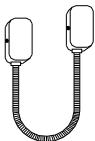

6220

**6200 SERIES DOOR CORD**  
 18" ARMORED DOOR CORD WITH SURFACE MOUNT J-BOX (INCLUDES 4 CONDUCTOR 22 AWG CABLE) STANDARD COLOR ALUMINUM

**\$50.00**

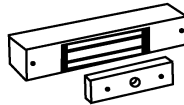

1110xD

**SINGLE DOOR 1200 LB LOCK w/ DOOR SWITCH**  
 (FOR USE w/ EDR-101 & 6420-S25 EGRESS BAR RELEASE)

**\$435.00**

1106xEDR

**SINGLE DOOR 650 LB LOCK w/ DPS & ATTEMPTED EGRESS SWITCH** (FOR USE w/ EXISTING HDWR.)

**\$460.00**

1110xEDR

**SINGLE DOOR 1200 LB LOCK w/ DPS & ATTEMPTED EGRESS SWITCH** (FOR USE w/ EXISTING HDWR.)

**\$510.00**

**NOTE: FOR DOUBLE DOORS**  
 USE TWO (2) #1110xEDR (SEE ABOVE)

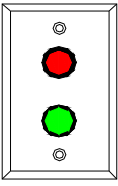
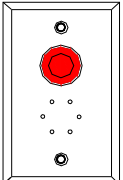
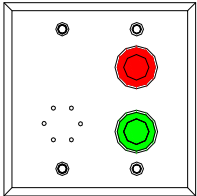
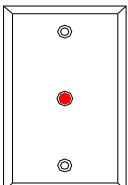

# ANNUNCIATORS

	<u>PART #</u>	<u>DESCRIPTION</u>	<u>LIST PRICE</u>
<b>7201 SERIES</b>			
<b>HI-INTENSITY LED INDICATORS</b>			
 <p>7201xL2-H</p>		<u>7201-H HI-INTENSITY LEDS 11/16" DIA.</u>	
	7201xL1*-H	1 HIGH INTENSITY LED MOUNTED ON A 1 GANG STAINLESS STEEL PLATE	\$60.00
	7201xL1*-HxCS	1 HIGH INTENSITY LED 1 PIEZO MOUNTED ON A 1 GANG STAINLESS STEEL PLATE	\$90.00
	7201xL2-H	1 EACH RED/GREEN HIGH INTENSITY LED MOUNTED ON A 1 GANG STAINLESS STEEL	\$112.00
 <p>7201xL1*-HWRxCSW</p>	7202xL2-HxCS	1 EACH RED/GREEN HIGH INTENSITY LED 1 PIEZO MOUNTED ON A 2 GANG STAINLESS STEEL PLATE * SPECIFY LED COLOR R=RED G=GREEN	\$142.00
	7201xL1*-HWR	<u>7201-HWR WATER PROOF HI-INTENSITY LEDS 1" DIA.</u> 1 WATER PROOF HIGH INTENSITY LED MOUNTED ON A 1 GANG STAINLESS STEEL PLATE	\$66.00
	7201xL1*-HWRxCSW	1 WATER PROOF HIGH INTENSITY LED 1 WATER PROOF (12VDC) PIEZO MOUNTED ON A 1 GANG STAINLESS STEEL PLATE	\$122.00
	7201xL2-HWR	1 EACH WATER PROOF RED/GREEN HIGH INTENSITY LED MOUNTED ON A 1 GANG STAINLESS STEEL PLATE	\$120.00
 <p>7202xL2-HWRxCSW</p>	7202xL2-HWRxCSW	1 EACH WATER PROOF RED/GREEN HIGH INTENSITY LED 1 WATER PROOF (12VDC)PIEZO MOUNTED ON A 2 GANG STAINLESS STEEL PLATE	\$176.00
	<b>STANDARD LED INDICATORS</b>		
 <p>7201xL1</p>		<u>7201 STANDARD LEDS SMALL DIA. 3/16"</u>	
	7201xL1	1 BICOLOR LED WITH CHROME BEZEL MOUNTED ON A 1 GANG STAINLESS STEEL PLATE	\$48.00
	7201xL2	2 BICOLOR LEDS WITH CHROME BEZEL MOUNTED ON A 1 GANG STAINLESS STEEL	\$68.00
	7201xCS	PIEZO CONTINUOUS SOUNDER ON 1 GANG SS *****REPLACES 7251 SERIES*****	\$46.00
	7201xCSW	WATER PROOF (12VDC) PIEZO SOUNDER ON 1 GANG SS PLATE	\$72.00
	(SUFFIX)	<u>ADD OPTIONAL LEDS</u>	(ADD)
	xL	FOR EACH ADDITIONAL STANDARD 3/16" DIA. LED MOUNTED ON PLATE	\$20.00
	(SUFFIX)	<u>ADD OPTIONAL PIEZO CONTINUOUS SOUNDERS</u>	(ADD)
	xCS	ADD PIEZO SOUNDER	\$30.00
	xCSW	ADD WATER PROOF (12VDC) PIEZO SOUNDER	\$56.00
(SUFFIX)	<u>ADD OPTIONAL SWITCHES</u>	(ADD)	
xT24	ADD FOR EACH DPDT-MAINTAINED TOGGLE	\$40.00	
xT25	ADD FOR EACH DPDT-MOMENTARY TOGGLE	\$40.00	
xP14	ADD FOR EACH SPDT-MAINT.PUSH BUTTON	\$25.00	
xP15	ADD FOR EACH SPDT-MOM PUSH BUTTON	\$25.00	
xP25	ADD FOR EACH DPDT-MOM PUSH BUTTON	\$45.00	
(SUFFIX)	<u>ADD CUSTOM ENGRAVING</u>	(ADD)	
xE6	PER PLATE FEE AFTER SET UP	\$20.00	
(ORDER AS LINE ITEM)---- XE6SETUP (PREFIX)	CUSTOM ENGRAVING 1 SET UP FEE PER RUN	\$60.00	
(PREFIX)	<u>ADD OPTIONAL MOUNTING PLATES</u>	(ADD)	
D	DOUBLE GANG SWITCH PLATE	\$12.00	
N	NARROW 1-3/4" PLATE FOR FRAME MOUNTING	\$8.00	



# ANNUNCIATORS

7200 SERIES	PART #	DESCRIPTION	LIST PRICE
-------------	--------	-------------	------------

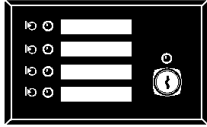

7204

7204	<b>7200 SERIES CUSTOM ANNUNCIATORS</b> <b>THREE GANG PLATE WITH 4-ZONE OVERLAY</b> ADD FOR LEDS, TOGGLE SWITCHES, PUSH BUTTONS, KEYSWITCH AND SOUNDER - COMPONENTS ALL HAVE FLYING LEADS (NO LOGIC OR TERMINALS INCLUDED)	\$160.00
------	---	----------

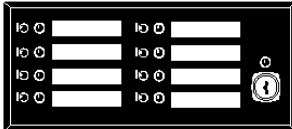

7208

7208	<b>FOUR GANG PLATE WITH 8-ZONE OVERLAY</b> ADD FOR LEDS, TOGGLE SWITCHES, PUSH BUTTONS, KEYSWITCH AND SOUNDER - COMPONENTS ALL HAVE FLYING LEADS (NO LOGIC OR TERMINALS INCLUDED)	\$180.00
------	---	----------

8 + ZONE PANELS ADD \$10.00 FOR EACH ZONE OVER 8 ZONES EA. ZONE \$10.00

NOTE: CUSTOM & RACK MOUNT CONFIGURATIONS AVAILABLE TO SUIT INDIVIDUAL APPLICATIONS (Call for quote)

7604/8-ENCL	SLOPED DESK TOP CONSOLE 4-8 ZONES 9" X 6" X 2-3/4" ALUMINUM BLACK ENAMEL FINISH	\$200.00
-------------	--	----------

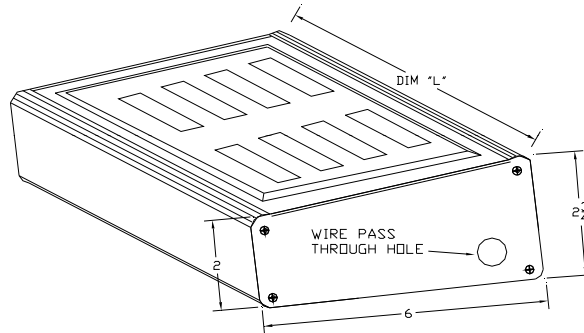

(SUFFIX)	7200 SERIES ADD ON COMPONENTS	(ADD)
xL	ADD FOR EACH BICOLOR LED W/CHROME BEZEL	\$20.00
xT24	ADD FOR EACH DPDT-MAINT.TOGGLE SWITCH	\$40.00
xT25	ADD FOR EACH DPDT-MOM.TOGGLE SWITCH	\$40.00
xP14	ADD FOR EACH SPDT-MAINT.PUSH BUTTON	\$25.00
xP15	ADD FOR EACH SPDT-MOM. PUSH BUTTON	\$25.00
xP24	ADD FOR EACH DPDT-MAINT. PUSH BUTTON	\$45.00
xP25	ADD FOR EACH DPDT-MOM. PUSH BUTTON	\$45.00
xCS	ADD PIEZO SOUNDER	\$30.00
xK24	ADD SPDT MAINTAINED KEY SWITCH	\$70.00
xTERM	10 POSITION DOUBLE ROW TERMINAL 6 1/2"	\$24.00
	<b>ADD CUSTOM ENGRAVING</b>	
	FOR STAINLESS 3&4 GANG PLATES WITHOUT OVERLAY	
xE6	PER PLATE FEE AFTER SET UP	\$40.00
	ADD PER GANG FEE OVER 4 GANG PLATE	\$20.00
(ORDER AS LINE ITEM)---- XE6SETUP	CUSTOM ENGRAVING 1 SET UP FEE PER RUN	\$60.00

NOTE: 7200 & 7250 SERIES ANNUNCIATORS ARE SUPPLIED WITH FLYING LEADS ONLY. FACTORY PRE-WIRED UNITS AVAILABLE UPON REQUEST (Call for quote)

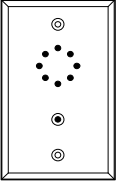
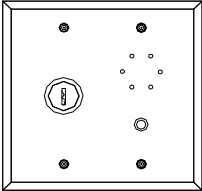
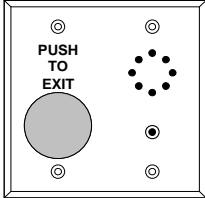
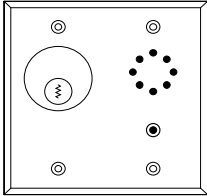

# ANNUNCIATORS

	<u>PART #</u>	<u>DESCRIPTION</u>	<u>LIST PRICE</u>
<b>7281 SERIES</b>	<b>LOCAL DOOR EXIT ALARMS</b>		
	7281-EA	<b><u>EXIT ALARM</u></b> DOOR ALARM WITH ADJUSTABLE (2 TO 60 SECONDS) DELAY, ALARM OUTPUT (DPDT) RELAY, TRI-STATE LED, AND LOCAL ALARM PIEZO (RESET ON DOOR RE-SECURE) ON STANDARD SINGLE GANG PLATE	\$195.00
7281-EA			
	7281-EAxK332	<b><u>EXIT ALARM WITH KEY SWITCH RESET</u></b> DOOR ALARM WITH ADJUSTABLE (2 TO 60 SECONDS) DELAY, ALARM OUTPUT (DPDT) RELAY, TRI-STATE LED, AND LOCAL ALARM PIEZO RESET BY DPDT MAINTAINED ELECTRIC KEYSWITCH PROVIDED. KEY REMOVABLE IN 2 POSITIONS ON STANDARD DOUBLE GANG PLATE	\$265.00
7281-EAxK332			
	7281-EAxMP23	<b><u>EXIT ALARM WITH PUSH BUTTON</u></b> DOOR ALARM WITH ADJUSTABLE (2 TO 60 SECONDS) DELAY, ALARM OUTPUT (DPDT) RELAY, TRI-STATE LED, AND LOCAL ALARM PIEZO (RESET ON DOOR RE-SECURE). INCLUDES MOMENTARY REX BUTTON 1-9/16" DIAMETER ON STANDARD DOUBLE GANG PLATE	\$300.00
7281-EAxMP23xE1			
	7281-EAxK24	<b><u>EXIT ALARM FOR MORTISE CYLINDER</u></b> DOOR ALARM WITH ADJUSTABLE (2 TO 60 SECONDS) DELAY, TRI-STATE LED, ALARM OUTPUT (DPDT) RELAY WITH LOCAL ALARM PIEZO (RE-SET BY MORTISE KEY SWITCH), INCLUDES 2 (DPDT) KEY SWITCH CONTACTS 1 MOMENTARY 1 MAINTAINED FOR ALARM SHUNT OR RESET ON DOUBLE GANG PLATE <b>(CYLINDER NOT INCLUDED ADD "XK" PER OPTIONS BELOW)</b>	\$300.00
7281-EA-K24xK			
	<b><u>(SUFFIX)</u></b>	<b><u>7281 EXIT ALARM OPTIONS</u></b>	<b><u>(ADD)</u></b>
	xCT	COVER TAMPER SWITCH SPDT	\$59.00
	xK	STANDARD 1-1/8" MORTISE CYLINDER & 2 KEYS	\$40.00
	xKNR	CYLINDER WITH KEY NON-REMOVABLE IN THE ON POSITION	\$50.00
	xW	OFF WHITE BAKED ENAMEL PLATE FINISH	\$20.00
	<b><u>(SUFFIX)</u></b>	<b><u>7281-EAxMP23 ENGRAVING OPTIONS</u></b>	<b><u>(ADD)</u></b>
	xE1	"PUSH TO EXIT" (RED TEXT)	\$14.00
	xE5	"EMERGENCY DOOR RELEASE" (RED TEXT)	\$20.00
		<b><u>ADD CUSTOM ENGRAVING</u></b>	
	xE6	PER PLATE FEE AFTER SET UP	\$20.00
(ORDER AS LINE ITEM)----	XE6SETUP	CUSTOM ENGRAVING 1 SET UP FEE PER RUN	\$60.00

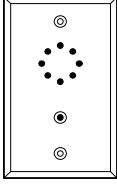
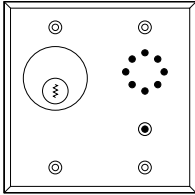
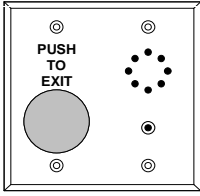

# ANNUNCIATORS

	<u>PART #</u>	<u>DESCRIPTION</u>	<u>LIST PRICE</u>
<b>7286 SERIES</b>		<b>LOCAL DOOR PROP ALARMS</b>	
	7286-PT5	<b><u>LOCAL DOOR PROP ALARM</u></b> DOOR PROP ALARM WITH ADJUSTABLE (0-SECONDS TO 90-MINUTES) DOOR OPEN DELAY, ALARM OUTPUT (DPDT) RELAY, TRI-STATE LED, AND LOCAL ALARM PIEZO, ADJUSTABLE LOCAL WARNING TIME DELAY & MIRRORED DOOR SWITCH OUTPUT	\$410.00
	7286-PT5-24	<b><u>DOOR PROP ALARM WITH KEY SWITCH</u></b> DOOR PROP ALARM WITH ADJUSTABLE (0-SECONDS TO 90-MINUTES) DOOR OPEN DELAY, TRI-STATE LED, ALARM OUTPUT (DPDT) RELAY WITH LOCAL ALARM PIEZO, ADJUSTABLE LOCAL WARNING TIME DELAY & MIRRORED DOOR SWITCH OUTPUT (RE-SET BY TIMER, DOOR RE-SECURE OR KEY SWITCH), INCLUDES 2 (DPDT) KEY SWITCH CONTACTS 1 MOMENTARY 1 MAINTAINED FOR ALARM SHUNT OR ALARM RESET ON DOUBLE GANG PLATE <b>(CYLINDER NOT INCLUDED ADD "XK" PER OPTIONS BELOW)</b>	\$535.00
	7286-PT5xMP23	<b><u>DOOR PROP ALARM WITH PUSH BUTTON</u></b> DOOR PROP ALARM WITH ADJUSTABLE (0-SECONDS TO 90-MINUTES) DOOR OPEN DELAY, TRI-STATE LED, ALARM OUTPUT (DPDT) RELAY WITH LOCAL ALARM PIEZO, ADJUSTABLE LOCAL WARNING TIME DELAY & MIRRORED DOOR SWITCH OUTPUT (AUTOMATIC ALARM RESET BY TIMER OR DOOR RE-SECURE), AND MOMENTARY ACTION PUSH BUTTON SWITCH (1-NO/1-NC) ON DOUBLE GANG PLATE	\$490.00
		<b><u>7286 DOOR PROP ALARM OPTIONS</u></b>	<b><u>(ADD)</u></b>
	<b>(SUFFIX)</b>		
	xCT	COVER TAMPER SWITCH SPDT	\$59.00
	xK	STANDARD 1-1/8" MORTISE CYLINDER & 2 KEYS	\$40.00
	xKNR	CYLINDER WITH KEY NON-REMOVABLE IN THE ON POSITION	\$50.00
	xW	OFF WHITE BAKED ENAMEL PLATE FINISH	\$20.00
	<b>(SUFFIX)</b>	<b><u>7286xMP23 ENGRAVING OPTIONS</u></b>	<b><u>(ADD)</u></b>
	xE1	"PUSH TO EXIT" (RED TEXT)	\$14.00
	xE5	"EMERGENCY DOOR RELEASE" (RED TEXT)	\$20.00
		<b><u>ADD CUSTOM ENGRAVING</u></b>	
	xE6	PER PLATE FEE AFTER SET UP	\$20.00
(ORDER AS LINE ITEM)----	XE6SETUP	CUSTOM ENGRAVING 1 SET UP FEE PER RUN	\$60.00

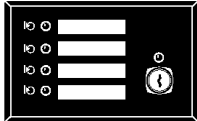
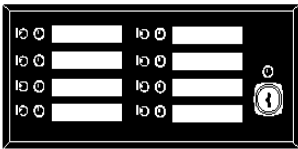

# ANNUNCIATORS

7600 SERIES	PART #	DESCRIPTION	LIST PRICE
		<b>MULTI-ZONE ANNUNCIATOR/CONTROLLERS</b>	
		<b><u>7600 ANNUNCIATOR MULTI-GANG CONSOLES</u></b>	
		ANNUNCIATOR/CONTROLLER WITH LED INDICATORS & TOGGLE SWITCHES FOR EACH ZONE. SECURITY KEY SWITCH FOR LED TEST, NORMAL CONTROL, RESTRICTED OPERATION, AND SILENCED ALERT SOUNDER MODE. CONFIGURED IN FOUR ZONE INCREMENTS MOUNTED ON MULTI-GANG STAINLESS STEEL SWITCH PLATES OR 19" WIDE RACK MOUNTABLE PLATES WITH BLACK OVERLAY SUITABLE FOR FLUSH MOUNTING.	
	7604-H	<b>4 ZONE HARDWIRED ANNUNCIATOR/CONTROLLER ON THREE GANG PLATE (6-1/2" WIDE x 4-1/2" HIGH x 2-1/2" DEEP)</b>	<b>\$750.00</b>
	<b>4 ZONE EXPANSION</b>	<b>ADD (TO #7604 ABOVE) FOR EACH ADDITIONAL 4 ZONE EXPANSION MODULE (EXAMPLES BELOW)</b>	<b>\$460.00</b>
		#7608 = \$1,210.00 (EIGHT ZONES TOTAL) #7612 = \$1,670.00 (TWELVE ZONES TOTAL) #7620 = \$2,590.00 (TWENTY ZONES TOTAL)	
	7608-H		
		<b><u>OPTIONAL MOMENTARY SWITCHES</u></b>	<b>ADD</b>
		MOMENTARY TOGGLES OR PUSH BUTTONS ARE AVAILABLE. SPECIFY UPON ORDERING. THESE ARE NON STOCK, CHECK FOR AVAILABILITY.	<b>\$120.00 FOR</b>
		<b>UTILIZING MOMENTARY PUSH BUTTONS DISABLES THE NORMALLY OPEN LOCK OUTPUT CAPABILITY; ONLY THE NORMALLY CLOSED OUTPUT IS ACTIVE</b>	<b>EVERY 4 ZONES</b>
	760006-K	SPARE KEY FOR 7600 ANNUNCIATOR *****MINIMUM OF 10 KEYS PER ORDER***** ALL 7600'S HAVE 2 ORIGINAL KEYS SUPPLIED MULTIPLE UNITS MAY BE SPECIFIED KEYED ALIKE	<b>\$30.00</b>

## DESK TOP ANNUNCIATOR ENCLOSURES

	<b><u>7600 SERIES SLOPED FACE ENCLOSURES:</u></b>	
	ALUMINUM CONSTRUCTION BLACK BAKED ENAMEL FINISH	
<b>7604/8-ENCL</b>	DESKTOP SLOPE FACE ENCLOSURE FOR FOUR OR EIGHT ZONE CONSOLES	<b>\$200.00</b>
<b>7612/16-ENCL</b>	DESKTOP SLOPE FACE ENCLOSURE FOR TWELVE OR SIXTEEN ZONE CONSOLES	<b>\$215.00</b>
<b>7620/24-ENCL</b>	DESKTOP SLOPE FACE ENCLOSURE FOR TWENTY OR TWENTY FOUR ZONE CONSOLES	<b>\$325.00</b>

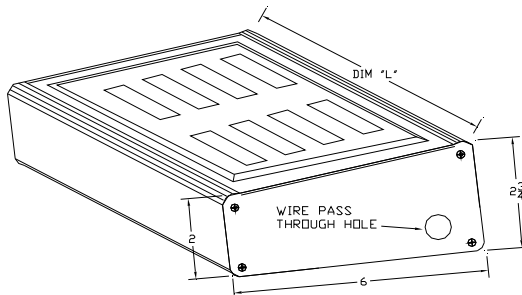



# ANNUNCIATORS

**7600 SERIES**

**PART # DESCRIPTION**  
**ANNUNCIATOR DIMENSIONS**

**LIST PRICE**

**7600 SERIES MOUNTING PLATE SIZES:**

Model #	Plate Width x Height	Plate Type	
#7604	6-1/2" x 4-1/2"	3-GANG SWITCH PLATE	(4-Zones)
#7608	8-1/4" x 4-1/2"	4-GANG SWITCH PLATE	(8-Zones)
#7612	11-3/4" x 4-1/2"	6-GANG SWITCH PLATE	(12-Zones)
#7616	13-1/2" x 4-1/2"	7-GANG SWITCH PLATE	(16-Zones)
#7620	17-1/2" x 4-1/2"	9-GANG SWITCH PLATE	(20-Zones)

**OPTIONAL RACK MOUNT PLATE**

7604 THRU 7620 MOUNTED ON RACK MOUNT PLATE '19" x 5-1/4" **ADD \$80.00**

**NO ADDITIONAL CHARGE FOR 7624 & LARGER RACK MOUNT PLATES**

Model #	Plate Width x Height	Plate Type	
#7624	19" x 5-1/4"	RACK MOUNT PLATE	(24-Zones)
#7628 *	19" x 7"	RACK MOUNT PLATE	(28-Zones)
#7632	19" x 7"	RACK MOUNT PLATE	(32-Zones)
#7636	19" x 10-1/2"	RACK MOUNT PLATE	(36-Zones)
#7640	19" x 7"	RACK MOUNT PLATE	(40-Zones)
#7644 *	19" x 10-1/2"	RACK MOUNT PLATE	(44-Zones)
#7648	19" x 10-1/2"	RACK MOUNT PLATE	(48-Zones)
#7652 *	19" x 10-1/2"	RACK MOUNT PLATE	(52-Zones)
#7656 *	19" x 10-1/2"	RACK MOUNT PLATE	(56-Zones)
#7660	19" x 10-1/2"	RACK MOUNT PLATE	(60-Zones)
#7664	19" x 12-1/4"	RACK MOUNT PLATE	(64-Zones)
#7668 *	19" x 18-1/2"	RACK MOUNT PLATE	(68-Zones)
#7672	19" x 18-1/2"	RACK MOUNT PLATE	(72-Zones)
#7676 *	19" x 12-1/4"	RACK MOUNT PLATE	(76-Zones)
#7680	19" x 12-1/4"	RACK MOUNT PLATE	(80-Zones)
#7684 *	19" x 18-1/2"	RACK MOUNT PLATE	(84-Zones)
#7688 *	19" x 18-1/2"	RACK MOUNT PLATE	(88-Zones)
#7692 *	19" x 18-1/2"	RACK MOUNT PLATE	(92-Zones)
#7696	19" x 18-1/2"	RACK MOUNT PLATE	(96-Zones)
#76100	19" x 15-1/4"	RACK MOUNT PLATE	(100-Zones)
#76104 *	19" x 18-1/2"	RACK MOUNT PLATE	(104-Zones)
#76108 *	19" x 18-1/2"	RACK MOUNT PLATE	(108-Zones)
#76112 *	19" x 18-1/2"	RACK MOUNT PLATE	(112-Zones)
#76116 *	19" x 18-1/2"	RACK MOUNT PLATE	(116-Zones)
#76120	19" x 18-1/2"	RACK MOUNT PLATE	(120-Zones)



**ELECTRICAL BACK BOXES FOR FLUSH WALL MOUNTING**

700353	3 GANG BACK BOX FOR 7604-H	\$36.00
700354	4 GANG BACK BOX FOR 7608-H	\$46.00
700356	6 GANG BACK BOX FOR 7612-H	\$60.00

\*Due to the physical layout of these units there may be additional zones which will be plugged on the plate with black plastic inserts to match the black overlay

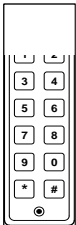
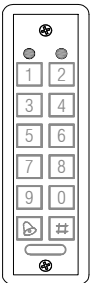

# ACCESS CONTROL

	<u>PART #</u>	<u>DESCRIPTION</u>	<u>LIST PRICE</u>
<b>8100 SERIES</b>	<b>KEYPAD ACCESS CONTROLS</b>		
		<b><u>8112 SERIES DIGITAL KEY PADS</u></b>	
	8112	USER PROGRAMMABLE DIGITAL KEY PAD SINGLE DOOR STAND-ALONE ACCESS CONTROL 120 USER CODES PROGRAMMED FROM KEYPAD 1 TO 90 SECONDS ADJUSTABLE TIME DELAY (RECOMMENDED FOR INTERIOR APPLICATIONS)	\$225.00
8112	8112-WR	WEATHER RESISTANT MEMBRANE KEY PAD SINGLE DOOR STAND-ALONE ACCESS CONTROL 120 USER CODES PROGRAMMED FROM KEYPAD 1 TO 90 SECONDS ADJUSTABLE TIME DELAY	\$325.00
	WR500351	WEATHER RESISTANT SURFACE MOUNT SINGLE GANG BOX FOR USE WITH 8112-WR	\$25.00
		<b><u>8160 SERIES HEAVY DUTY DIGITAL KEY PADS</u></b>	
	8160	HEAVY DUTY, ALL METAL, TOUCH SENSITIVE, WEATHERPROOF, KEYPAD SINGLE DOOR STAND ALONE ACCESS CONTROL WITH 200 ACTIVE USER CODES <b>ELECTRONICS PROTECTED BY REMOTELY LOCATED CONTROL PANEL.</b>	
8160	8160	SINGLE GANG STYLE WATERPROOF/VANDAL RESISTANT KEYPAD FOR SURFACE MOUNTING ON FLAT WALL SURFACES	\$675.00
	8160xNS	NARROW STYLE WATERPROOF/VANDAL RESISTANT KEYPAD FOR SURFACE MOUNTING ON 1-3/4" DOOR FRAMES	\$675.00
	8160xINT	<b>INTEGRATED UNIT WITH ON-BOARD ELECTRONICS 200 USER CODES (NO CONTROL PANEL) SPDT. RELAY OUTPUT N.O. PUSH BUTTON SWITCH INPUT</b>	\$475.00
8160xNS	8160xNSxINT	<b>NARROW INTEGRATED UNIT WITH ON-BOARD ELECTRONICS 200 USER CODES (NO CONTROL PANEL) SPDT. RELAY OUTPUT N.O. PUSH BUTTON SWITCH INPUT</b>	\$475.00
		<b><u>WIEGAND OUTPUT FORMATS</u></b>	
	8160xWG	26 BIT WIEGAND OUTPUT	\$425.00
	8160xW8	8 BIT WORD OUTPUT	\$425.00
	8170xNS	NARROW WATERPROOF/VANDAL RESISTANT KEYPAD WITH 26-BIT WIEGAND OUTPUT FOR MULLION MOUNTING (REPLACES 8160xNSxWG)	\$350.00
	8170011	FLUSH MOUNT ADAPTER PLATE FOR 8170xNS (FACILITATES 1 GANG FLUSH MOUNTING)	\$40.00
8170xNS		<b><u>KEY PAD PROX READER COMBINATION</u></b>	
	8160xHR	KEY PAD WITH HID PROX READER 26 BIT WIEGAND	\$875.00
	8160xHR-8	KEY PAD WITH HID PROX READER 8 BIT WIEGAND	\$875.00
		<b><u>CONTROLLER EXTENSION CABLES</u></b>	
	816020CA	20 FOOT CABLE FOR 8160 CONTROLLER	\$110.00
	816040CA	40 FOOT CABLE FOR 8160 CONTROLLER	\$210.00
	WR500351	WEATHER RESISTANT SURFACE MOUNT SINGLE GANG BOX FOR USE WITH 8160 / 8160xINT	\$25.00



# MISCELLANEOUS

## MAG LOCK

<u>PART #</u>	<u>DESCRIPTION</u>	<u>LIST PRICE</u>
---------------	--------------------	-------------------

<b>REPLACEMENT PARTS</b>		
<b><u>MAGLOCK REPLACEMENT PARTS</u></b>		
1000701	LOCK MOUNTING KIT 1000 SERIES	\$10.00
1000702	TJ LOCK MOUNTING KIT 1000 SERIES	\$8.00
1100701	SINGLE LOCK MOUNTING KIT 1106, 1110, 1150	\$8.00
1100702	SINGLE TJ-LOCK MOUNT KIT TJ1106, TJ1110, TJ1150	\$10.00
1100721	DOUBLE LOCK MOUNTING KIT 1120, 1152	\$10.00
1100722	DOUBLE TJ-LOCK MOUNTING KIT TJ1120, TJ1152	\$12.00
1100703	ARMATURE MOUNTING KIT 1-3/4" DOOR	\$16.00
1100703.25	ARMATURE MOUNTING KIT 2-1/4" DOOR	\$24.00
1100704	TJ-TOP JAMB ARMATURE MOUNTING KIT	\$14.00
1000051	1000 SERIES ARMATURE	\$54.00
1000054	1000 DPS ARMATURE W/ACTUATING MAGNET	\$68.00
1106051	1106 SERIES ARMATURE	\$50.00
1106054	1106 DPS ARMATURE W/ACTUATING MAGNET	\$66.00
1115051	1115 SERIES ARMATURE	\$50.00
1115054	1115 DPS ARMATURE W/ACTUATING MAGNET	\$66.00
1110051	1110 SERIES ARMATURE	\$54.00
1110054	1110 DPS ARMATURE W/ACTUATING MAGNET	\$68.00
1160011	DPS ACTUATING MAGNET ONLY	\$12.00
1160015	DPS SWITCH ONLY SPDT W/LEADS	\$28.00
1610051	1150 SERIES ARMATURE	\$66.00
1610054	1150 DPS ARMATURE W/ACTUATING MAGNET	\$72.00
1610155	1155 SERIES ARMATURE	\$64.00
1610154	1155 DPS ARMATURE W/ACTUATING MAGNET	\$70.00
<b><u>OFFSET ARMATURE PLATE</u></b>		
1610051-OS	1150 SERIES ARMATURE (OFF SET)	\$68.00
1610054-OS	1150 DPS ARMATURE W/ DOOR SWITCH MAGNET	\$74.00
<b><u>SURFACE MOUNT ARMATURE PLATE</u></b>		
1110050	FOR 1000,1110,1150 (2 REQ. FOR 1120/1152/1155)	\$76.00
1115050	FOR 1106, 2 REQUIRED FOR 1115 SERIES	\$70.00

## "Z" BRACKETS

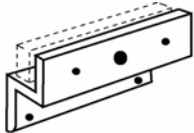

<b><u>TOP JAMB Z-BRACKETS w/ SEX NUT</u></b>		
1096-00	Z-BRACKET FOR 1000 "TJ" LOCKS	\$84.00
1196-06	Z-BRACKET FOR 1106 "TJ" LOCKS	\$72.00
1196-10	Z-BRACKET FOR 1110 "TJ" LOCKS	\$84.00
1196-15L	Z-BRACKET FOR 1115 "TJ" LOCKS	\$68.00
1196-15R	Z-BRACKET FOR 1115 "TJ" LOCKS	\$68.00
1196-50	Z-BRACKET FOR 1150 "TJ" LOCKS	\$104.00
1196-55L	Z-BRACKET FOR 1155 "TJ" LOCKS	\$80.00
1196-55R	Z-BRACKET FOR 1155 "TJ" LOCKS	\$80.00
1196703	Z-BRACKET MOUNTING KIT	\$22.00
<b><u>(SUFFIX)</u></b>		
<b><u>Z- BRACKET SPECIAL FINISHES</u></b>		
xDBA	ADD FOR DARK BRONZE ANODIZED Z-BRACKET	\$20.00
xSBA	ADD FOR SATIN BLACK ANODIZED Z- BRACKET	\$20.00
xUS3	ADD FOR POLISHED BRASS Z-BRACKET	\$170.00
xUS26	ADD FOR POLISHED CHROME Z-BRACKET	\$170.00
xUS4	ADD FOR SATIN BRASS Z-BRACKET	\$165.00
xUS26D	ADD FOR SATIN CHROME Z-BRACKET	\$165.00



# MISCELLANEOUS

<u>PART #</u>	<u>DESCRIPTION</u>	<u>LIST PRICE</u>
<b>SWITCH REPLACEMENT PARTS</b>		
<b>5140 SERIES PARTS</b>		
5141090	CYLINDER W/ 2 KEYS FOR 5141 SERIES	\$40.00
5141703	CYLINDER MOUNTING KIT FOR 5141 KEY SWITCH	\$15.00
<b>5215 SERIES SWITCHES</b>		
5215015	SPDT MOM ACTION SW. 8" LEADS	\$25.00
<b>5230 SERIES SWITCHES</b>		
5230014L	SPDT MAINTAINED SNAP ACTION SW. 8" LEADS	\$25.00
5230015L	SPDT MOMENTARY SNAP ACTION SW. 8" LEADS	\$25.00
<b>5140 &amp; 5280 SERIES SWITCHES</b> <i>(SPECIFY IF REPLACEMENT SWITCH IS FOR A KEY SWITCH OR A PUSH BUTTON)</i>		
5280024L	DPDT MAINTAIN ACTION SWITCH W/8" LEADS	\$37.00
5280025L	DPDT MOMENTARY ACTION SWITCH W/8" LEADS	\$37.00
<b>TIME DELAY REPLACEMENT PARTS</b>		
5220023L	PNEUMATIC 2-60 SEC. TIME DELAY SWITCH	\$220.00
52800AT	AT ADJUSTABLE 2-60 SEC.TIMER DPDT 12/24 VDC	\$60.00
52800FT	FT FIXED 30 SEC.TIMER DPDT 12/24 VDC	\$60.00
4504001	ET TIMER 2-60 SEC. DPDT 12/24 VDC	\$100.00
<b>ELECTRICAL BOXES &amp; ACCESSORIES</b>		
500351	1-GANG STANDARD ELECTRICAL BOX	\$15.00
500352	2-GANG STANDARD ELECTRICAL BOX	\$20.00
WR500351	1-GANG WEATHER RESISTANT ELECTRICAL BOX	\$25.00
WR500352	2-GANG WEATHER RESISTANT ELECTRICAL BOX	\$30.00
WM500351	1-GANG WIRE MOLD SURFACE MOUNT BACK BOX (STOCKED IN 1-3/8" AND 2-3/4" DEEP)	\$36.00
N500351	NARROW 1-3/4" JAMB MOUNT BACK BOX BLACK HIGH IMPACT PLASTIC CONSTRUCTION	\$44.00
<b>LED REPLACEMENT PARTS</b>		
7020251	BLACK PLASTIC BEZEL (BICOLOR RED / GREEN) W/6" LEADS	\$12.00
7020256	CHROME BEZEL FOR HD AND 7200 SERIES ANNUNCIATORS (BICOLOR RED / GREEN)	\$20.00
7020252-HI	HI INTENSITY RED W/6" LEADS	\$60.00
7020255-HI	HI INTENSITY GREEN W/6" LEADS	\$60.00
7020252-HI-WR	WEATHER PROOF HI INTENSITY RED 6" LEADS	\$66.00
7020255-HI-WR	WEATHER PROOF HI INTENSITY GREEN 6" LEADS	\$66.00
<b>MISC. REPLACEMENT PARTS</b>		
6410015-J	6420 / 6495 SERIES SPDT REPLACEMENT SWITCH (2 REQUIRED PER DEVICE)	\$28.00
6410015-JWR	WEATHER PROOF SWITCH FOR SAME AS ABOVE	\$42.00
1100640	xCT COVER TAMPER REPLACEMENT SWITCH	\$28.00
LA-LABEL DOOR SIGN 15-30	DELAYED EGRESS NFPA 101 SIGNAGE	\$10.00

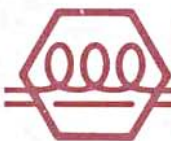

# DORTRONICS SYSTEMS, INC.

1668 Sag Harbor Tpke., Sag Harbor, N.Y. 11963 • Tel (631) 725-0505 • 800-906-0137 • Fax (631) 725-8148

## CREDIT APPLICATION

COMPANY NAME: \_\_\_\_\_ PH: \_\_\_\_\_  
STREET ADDRESS: \_\_\_\_\_ FX: \_\_\_\_\_  
CITY: \_\_\_\_\_ STATE: \_\_\_\_\_ ZIP: \_\_\_\_\_

### PRINCIPALS

### TITLE OR POSITION

NAME: \_\_\_\_\_  
NAME: \_\_\_\_\_  
NAME: \_\_\_\_\_  
NAME: \_\_\_\_\_

BANK: \_\_\_\_\_ BRANCH: \_\_\_\_\_  
ADDRESS: \_\_\_\_\_ PH: \_\_\_\_\_ EXT: \_\_\_\_\_  
CITY: \_\_\_\_\_ STATE: \_\_\_\_\_ ZIP: \_\_\_\_\_  
PERSON TO CONTACT: \_\_\_\_\_ POSITION: \_\_\_\_\_

AMOUNT OF CREDIT REQUESTED: \$ \_\_\_\_\_

### CREDIT REFERENCES

1: \_\_\_\_\_ 2: \_\_\_\_\_

PH: \_\_\_\_\_ FX: \_\_\_\_\_ PH: \_\_\_\_\_ FX: \_\_\_\_\_  
ACCOUNT #: \_\_\_\_\_ ACCOUNT #: \_\_\_\_\_

3: \_\_\_\_\_ 4: \_\_\_\_\_

PH: \_\_\_\_\_ FX: \_\_\_\_\_ PH: \_\_\_\_\_ FX: \_\_\_\_\_  
ACCOUNT #: \_\_\_\_\_ ACCOUNT #: \_\_\_\_\_

### TERMS & CONDITIONS:

In consideration of credit extended we agree to pay invoices due within 30 days of invoice date. A 2% interest fee may be applied to past due invoices.

#### DEFAULT:

In the case of default, all collection charges, Lawyers fees and interest will be borne by the applicant Company.

We understand your terms and conditions as stated above and agree to abide by them in making this application for credit. I also understand that an investigative consumer report may be made.

We hereby authorize the release of any information from the above business references and our bank.

**ALL REPLIES WILL BE KEPT CONFIDENTIAL**

**Signature required below by Company officer or duly authorized representative.**

SIGNATURE: \_\_\_\_\_ TITLE: \_\_\_\_\_

PRINT NAME: \_\_\_\_\_ DATE: \_\_\_\_\_

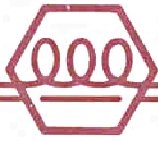

## SALES - POLICIES AND PROCEDURES

### Papers Needed to Open an Account:

A credit application is filled out and returned for processing. If customer is approved, they are set up on a Net-30 Day Terms. Note: If customer information received back (bank, trade references, Dunn & Bradstreet) is inconclusive, the sales representative will help decide terms (Net or COD).

Credit cards are also accepted: Visa, Mastercard and American Express.

**Dortronics Systems, Inc. will not accept Credit card information via e-mail.**

### Minimum Order:

There is no minimum order; however, if a customer is going to buy a small quantity, low dollar amount on a one-time basis, the order will be shipped COD or credit card. Customer also has the option to send payment in advance.

### Freight Policy:

Freight is prepaid and billed on all invoices which are mailed the day after shipment.

Carriers used are UPS, FED-EX and trucking. Customer may choose to use own account.

### Drop ship Info:

To be advised during verbal phone order, or specified on E-mail or faxed purchase orders.

### Contact (Sales):

Mike Palermo – Sales/Customer Service

Stuart Arthur – Sales/Applications Specialist

Bryan Sanderford - National Sales Manager

### Contact (Technical):

Joe Hanna – Engineer/Applications Specialist

Kevin King – Engineering Support

### Contact (Credit):

Teri Harboy – Accounting; New Customer Accounts

### Special Dealer Programs:

Large quantity discount pricing is negotiable and reviewed on a situation-by-situation basis.

### Product Warranties

All electromagnetic locks have a **LIFETIME GUARANTEE** against defects in material and workmanship. Defective units will be replaced or repaired based upon incoming evaluation and inspection.

All other Dortronics components of the Electric Locking System shall be similarly warranted for a period of one year. Expressed warranties are conditionally based on the requirement that the items covered within the guarantee are used and maintained in accordance with the manufacturer's recommendations.

### Returns:

A Return Authorization Number must be obtained and accompany all returns within 14 days of issue.

Unused items returned for credit must be complete and packed in original unit box and are subject to a 15% restocking fee. Any shipping or order discrepancies must be reported within 5 days of receipt.