

The RL Series has been enhanced to offer removable throughbolts and a wide variety of designs, finishes and functions. The RL Series cylindrical locksets are an economical value for a variety of application. Perfect for multi-family housing markets, as well as light commercial applications.



### Certification

The RL Series has been designed to meet the requirements of ANSI, A156.2, Series 4000, Grade 2 UL Listed for use on 3 hour, A label single swinging doors.

RL Levers conform to ADA requirements.

### ADA/Americans with Disabilities Act

#### Acceptable Door Hardware: Section 4.13.9

Handles, pulls, latches and other operating devices on accessible doors shall have a shape that is easy to grasp with one hand and does not require grasping, tight pinching or twisting of the wrist to operate. Lever operated mechanisms, push-type mechanisms and "U" shaped handles are acceptable designs.

 Look for the universal symbol next to Arrow products that comply with ADA accessibility requirements.

### Features

**Construction** – Cold rolled steel with zinc dichromate finish for corrosion resistance. Requires standard 2-1/8" (53.97mm) bore through door.

**Backset** – 2-3/8" (60.31mm) or 2-3/4" (69.85mm)

**Door Thickness** – Fits 1-3/8" (34.93mm) to 1-3/4" (44.45mm) doors standard.

**Latch** – Brass 1/2" (12.7mm) throw, UL Listed, guarded latchbolt on all locking functions

**Latch Front** – 1" x 2-1/4" (25.40mm x 57.15mm) for 2-3/8" backset (60.32mm) or 1-1/8" x 2-1/4" for 2-3/4" (69.85mm) backset.

**Exposed Trim** – RL Levers are pressure cast zinc measuring 4-3/4" (120.65mm) in length. RL Roses are wrought brass 3-3/8" (85.73mm) diameter. Total projection from face of door is 2-1/2" (63.5mm).

**Strike** – 4-7/8" ANSI (123.83mm), 2-3/4" (69.85mm) T strike, or 2-1/4" (57.15mm) full lip strike.

**Cylinder** – Solid brass 6 pin. Arrow "A" keyway standard. C keyway optional.

**Keys** – 2 brass keys

**Handing** – Non-handed

**Thru-bolts** – Removable thru-bolts standard on RL Series

**Packaging** – 10 per case

**Warranty** – Five Year Mechanical Warranty

### Finishes:

RK is available in 03, 04, 10, 10B, 32 and 32D.



	BHMA	U.S. Equivalent	Arrow Equivalent	Finish
<b>1</b>	605	US3	03	Bright Brass
<b>2</b>	606	US4	04	Satin Brass
<b>3</b>	612	US10	10	Satin Bronze
<b>4</b>	613	US10B	10B	Dark Oxide Bronze, Oil Rubbed
<b>5</b>	625	US26	26	Bright Chromium Plated
<b>6</b>	626	US26D	26D	Satin Chromium Plated

## RL Series Cylindrical Levers

RL Series lever designs

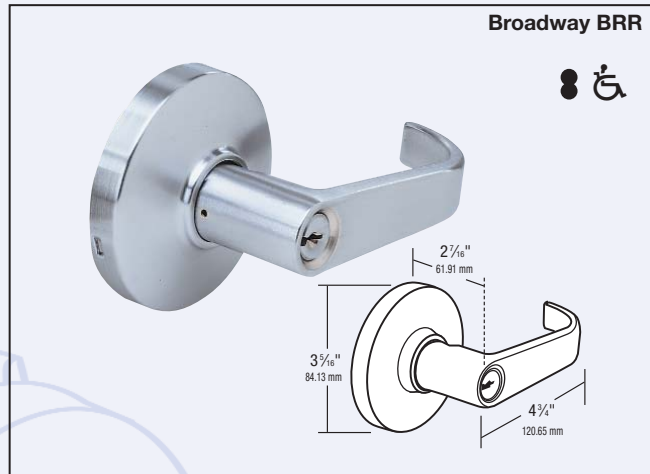
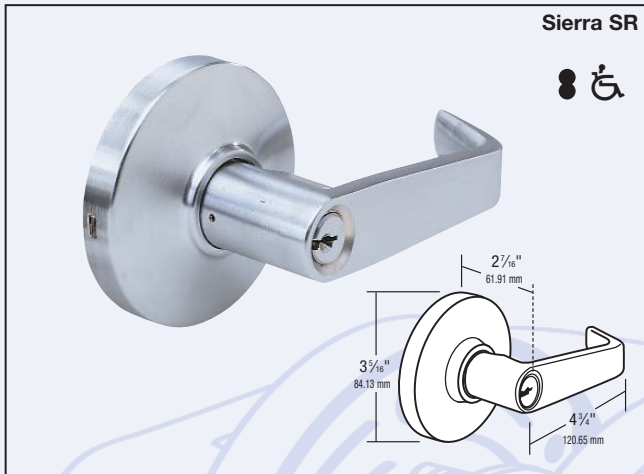

R Series cylinders

Solid Brass 6 pin cylinder pinned 5 for RK, pinned 6 for RL. "A" Keyway standard. Arrow sectional keyways available. Competitive keyways available. US4, US26D finish.

Tailpieces

Part #	Series
1001-44	RL Series
550AM-44	RK Series

Interchangeable Core

Look for this symbol to indicate availability of product with interchangeable core design.

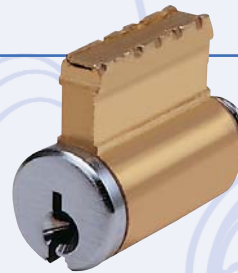

Cylinder Part

- #100C – RK Series
- #600HD – RL Series

RL Series Cylindrical Levers

Latches & Strikes:

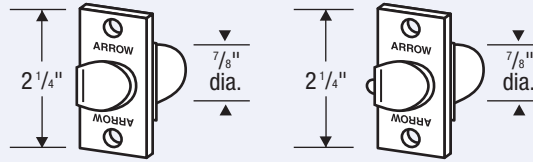

Latch Standards	UL Spring Latches	UL Dead Latches	Strikes
2-3/8" Backset	<p>#R72</p>	<p>#R70</p>	<p>#300 #302</p> <p>ANSI 115.3</p>
2-3/4" Backset	<p>#R73</p>	<p>#R71</p>	<p>#303 #306</p> <p>ASA ANSI 115.2</p>

Accessories:

Strikes	R62 Strike	R60 Strike	R61 Strike
	<p>Standard with RL Series</p> <p>ASA ANSI 115.2</p>	<p>Standard with RK Series</p> <p>ANSI 115.3</p>	

Installation:



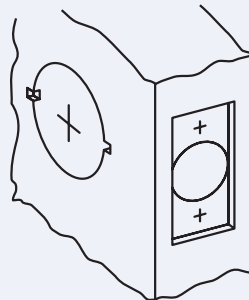

161 prep for retrofit and secure installation.

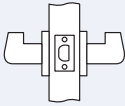
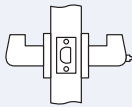
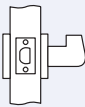

RL Series Cylindrical Levers

ASSA ABLOY, the global leader in door opening solutions

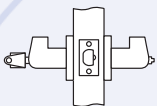
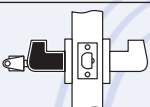
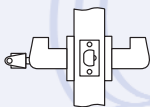

Arrow Standard	Function		Description
RL01	Passage		Latchbolt operated by lever either side.
RL02	Privacy		Latchbolt operated by lever either side except when inside turnbutton locks outside. Unlocked by rotating button or by using tool outside.
RL03	Communicating		Latchbolt by inside lever only. Blank rose only outside.
RL08	1/2 Dummy Trim		Rigid trim for one side of door only. Used as pull or to match active trim.
RL11	Entrance		Latchbolt operated by lever either side except when outside lever is locked by turn-button inside. When outside lever is locked, latchbolt operated by key outside or turning inside lever. Inside button must be manually released.
RL12	Storeroom		Outside lever always rigid. Latchbolt operated by key in outside lever, or by turning inside lever.
RL17	Classroom		Latchbolt operated by lever either side except when key outside locks outside lever. Inside lever always free. Key outside locks/unlocks outside lever only.
			Indicates lever rigid at all times.

**How To Order:**

**Example:** To order a RK Series entry function lockset with a Ball design lever, satin stainless steel finish, with a R60 strike, and 2-3/4" deadlocking latch, keyed different:

**Specify:**

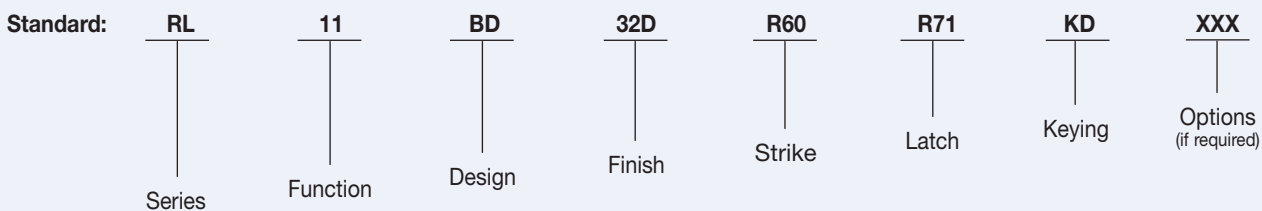

RL Series Cylindrical Levers

ASSA ABLOY, the global leader in door opening solutions

