

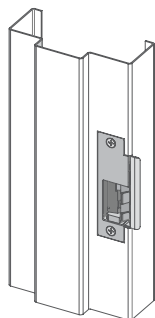

The 8500 series is a fire rated, compact, high performance electric strike featuring a unique concealed design for use with mortise locksets without a deadbolt. Designed for fast, convenient installation, the 8500 installs with little or no modification to the frame. Simply remove the existing strike plate, remove the dust box and install. Its strength is derived from a unique keeper pin locking design, enabling the 8500 to exceed Grade-1 ratings. This unique electric strike complies with NFPA 80-07 guidelines for retrofit into fire-rated frames. The 8500 accommodates mortise latchbolts up to 3/4" throw.



8500 Series

The fire-rated, concealed electric strike solution for mortise locksets

Specifications

- UL 10C-fire-rated, 3 hour single-door fire (fail secure only)
- CAN4-S104 (ULC-S104) fire door conformant
- NFPA 80-07 Compliant
- UL 1034 burglary-resistant listed and suitable for outdoor use
- UL 294 (6th Edition) listed
- ANSI/BHMA A156.31, Grade 1
- NFPA -252 fire door conformant
- ASTM-E152 fire door conformant

- RoHS compliant
- Patent: 8,783,744
- Patent Pending

Frame Application

- Metal
- Wood

Electrical

- .24 Amps at 12 VDC/VAC
- .12 Amps at 24 VDC/VAC
- DC continuous duty/AC intermittent duty only
- PoE friendly

8500 Models

8500	Universal electric strike	Faceplate options ordered separately, see page 42
RF8510	Integrated Prox	Includes the strike body, Prox reader and door position switch
IC8520	Integrated iCLASS®	Includes the strike body, iCLASS reader and door position switch

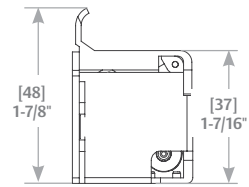
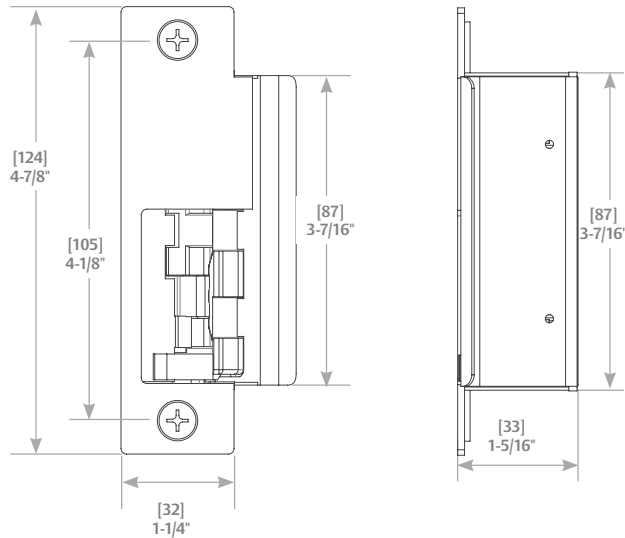

Removal of the dustbox required for use with ANSI/BHMA A156.115 prep

Standard Features

- No cutting to the face of the frame
- Stainless steel construction
- Tamper-resistant
- Static strength 1,500 lbs.
- Dynamic strength 70 ft-lbs.
- Endurance 500,000 cycles
- Field selectable fail secure/fail safe
- Dual-voltage 12 or 24 VDC/VAC
- Non-handed
- Metal or wood frame
- Internally mounted solenoid
- Accommodates 3/4" mortise latchbolts

- Strike body depth 1-5/16"
- Plug-in connector
- Full pocket shims for horizontal adjustment
- Five-year limited warranty

Optional Features

- **LBM** » Latchbolt Monitor
- **LBSM** » Latchbolt Strike Monitor
- 4 faceplate option kits to work with most mortise locksets, see page 42

Accessories

- 150** » Strike latch guard
- 2001M** » Plug-in bridge rectifier
- 2004M** » ElectroLynx® adapter
- 2005M3** » SMART Pac® III
- 2006M** » Plug-in buzzer

Finishes

- 630** » Satin stainless steel
- 605** » Bright brass
- 606** » Satin brass
- 612** » Satin bronze
- 613** » Bronze toned
- 629** » Bright stainless steel



MORTISE LOCKS
WITHOUT
DEADBOLTS



FIELD SELECTABLE
(12 OR 24VDC)



FIELD SELECTABLE
(FAIL SECURE/
FAIL SAFE)



FIRE RATED



GRADE 1



OUTDOOR
RATED



UL 1034
BURGLARY
LISTED

hes
ASSA ABLOY

8500 Series Faceplate Option Kits

The 8500 faceplate options kits combine two different faceplate pocket styles with three different deadlatch platform profiles for compatibility with a wide variety of mortise locksets. HES 8500 faceplate option kits

are lock specific. There are two faceplates included in each kit: a standard faceplate and a faceplate with a wider pocket to address less-than-ideal sagging door conditions.



Operation: After release, the keeper returns to the locked position

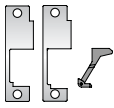

4-7/8" x 1-1/4"

851M Option

For use with: Mortise locksets

Compatible locksets: Sargent 8100, 8200, 9200

» ANSI/BHMA Numbers: E05031, E09321, E09322, E09323

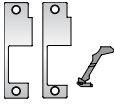

4-7/8" x 1-1/4"

852K Option

For use with: Mortise locksets

Compatible locksets: Corbin Russwin ML 2000

» ANSI/BHMA Numbers: E05031, E09321, E09322, E09323

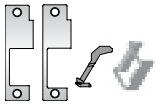

4-7/8" x 1-1/4"

852L Option

For use with: Mortise locksets

Compatible locksets: Schlage L9000

» ANSI/BHMA Numbers: E05031, E09321, E09322, E09323

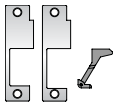

4-7/8" x 1-1/4"

852M Option

For use with: Mortise locksets

Compatible locksets: Yale 8700 (manufactured after 2005) & 8800, Accurate, Falcon, Kaba Ilco/Unican

» ANSI/BHMA Numbers: E05031, E09321, E09322, E09323



"For use with" information is offered as a recommendation only. Reference should be made to the lockset manufacturer for proper installation instructions necessary to meet compatibility requirements.

Get to Know the HES 8500

The HES 8500 concealed electric strike for mortise locksets builds on the tradition of ground-breaking design you've come to know in the 8000 series concealed electric strike family. It has a unique design unlike

any electric strike on the market today. It's important to understand the extraordinary design of the 8500, so that you can correctly install and operate it.

When the door is closed, the mortise latchbolt is held secure by the 8500 keeper. A 'deadlatch platform' insert holds the deadlatch in its locked state. Place the deadlatch platform into one of three locations in the strike as appropriate for the type of mortise lockset.

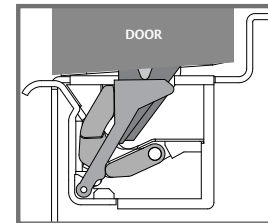

When the electric strike is energized, the keeper begins to rotate and the deadlatch platform falls away, allowing the deadlatch to drop and the latchbolt to become unguarded.

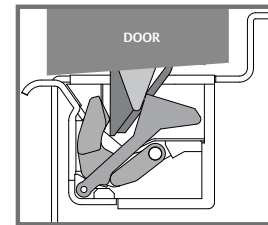

As the door moves forward, the latchbolt slides first along the keeper and then up the internal ramp.

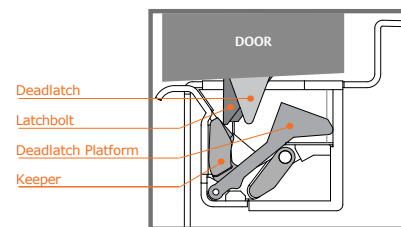

As the door continues along its arc away from the frame, the latchbolt and deadlatch exit the 8500, which quickly returns to its locked state.

