



5000 SERIES POWER SUPPLY/CHARGERS INSTALLATION GUIDE

MODEL# 5025 (1 AMP @ 12VDC OR 24VDC)

MODEL# 5500 (3 AMP @ 12VDC OR 2 AMPS @ 24VDC)

MODEL# 5600-12 (10 AMPS @ 12VDC)

MODEL# 5600-24 (5 AMPS @ 24VDC)

IMPORTANT SAFETY INSTRUCTIONS

THIS MANUAL CONTAINS IMPORTANT SAFETY INSTRUCTIONS FOR
POWER SUPPLY/BATTERY CHARGER MODELS:

5025, 5500, 5600-12, 5600-24

BEFORE USING THE BATTERY CHARGER, READ ALL INSTRUCTIONS AND
CAUTIONARY MARKINGS ON THE BATTERY CHARGER,
BATTERY/BATTERIES AND PRODUCTS USING BATTERIES

**WWW.DYNALOCK.COM
705 EMMETT STREET
BRISTOL, CT 06011-2728
PHONE: (860) 582-4761 FAX: (860) 585-0338**

REV. 8/30/2010

OVERVIEW

These access control power supply/chargers are specifically designed for use with access control systems and accessories. These units convert a 115VAC/50-60Hz input into two outputs (see options). Outputs will route power to a variety of access control hardware devices including Mag Locks, Electric Strikes, Magnetic Door Holders, ect. These outputs will operate in both Fail-Safe and Fail-Secure modes.

5000 SERIES POWER SUPPLY CONFIGURATION REFERENCE CHART

DYNALOCK MODEL NUMBER	12VDC CURRENT OUTPUT	24VDC CURRENT OUTPUT	OUTPUTS	115VAC/60HZ INPUT CURRENT DRAW	INPUT FUSE RATING	AGENCY LISTINGS	UL LISTINGS & FILE NUMBERS
5025 (12/24VDC FIELD SELECTABLE)	1 AMP	1 AMP	2	.45 AMPS	RESETTABLE	 <small>Approved NYCC Dept. of Buildings</small>	3S84 File# E183665
5500 (12/24VDC FIELD SELECTABLE)	3 AMPS	2 AMPS	2	1 AMP	1 AMP		# 23-92-E
5600 (12 OR 24VDC FIXED)	10 AMPS	5 AMPS	2	2 AMPS	4 AMPS		

INSTALLATION INSTRUCTIONS

Wiring methods shall be in accordance with the National Electric Code/NFPA 72/ANSI, and with all local codes and authorities having jurisdiction. Product is intended for indoor use only.

1) Mount unit in desired location. mark and pre-drill holes to line up with the top two keyholes in the enclosure. Install two upper fasteners and screws with screw heads protruding. Place the enclosures upper keyholes over the two upper screws, level and secure. Mark the position of the lower two holes. Remove the enclosure and drill the lower two holes. Place the enclosures upper key holes back over the two upper screws. Install the two lower screws and make sure to tighten all screws (Enclosure Dimensions, pg 12). Secure the enclosure to earth ground.

2) Set the output voltage: 5025, 5500 set the desired output voltage by setting the voltage selector to the appropriate position on the power supply main board.

Note: The 5600 is not field selectable and the output voltage must be specified when ordering.

3) Secure green/yellow stripe lead to earth ground. Connect AC power (115VAC 60Hz) to terminals marked (H or L, G, N) on the power supply board. Use 18AWG wire or larger for all power connections (Battery, DC output, AC input).

4) Measure output voltage before connecting any devices. This will help prevent damage from occurring. **Keep power limited wiring separate from non-power limited wiring (115VAC/60Hz Input, Battery Wires). Minimum .25" spacing must be provided.**

5) Connect Fail-Safe or Fail-Secure type locking hardware (e.g. Door strikes, Mag Locks and Electric Deadbolts) positive leads to the terminals marked (+) DC OUTPUT and the negative leads to the terminals marked (-) DC OUTPUT.

INSTALLATION INSTRUCTIONS (CONT'D)

6) For access control applications, batteries are optional. When batteries are not used, a loss of AC voltage will result in the loss of output voltage. Batteries must be sealed lead acid rechargeable types if used. Connect one 12VDC battery to terminals marked (Battery) on the power supply board for 12VDC operations. Use two 12VDC batteries connected in series for 24VDC operations. Battery leads are included when batteries are ordered with the power supply.

7) Please insure enclosure cover is secured closed with the provided screw or the key lock option.

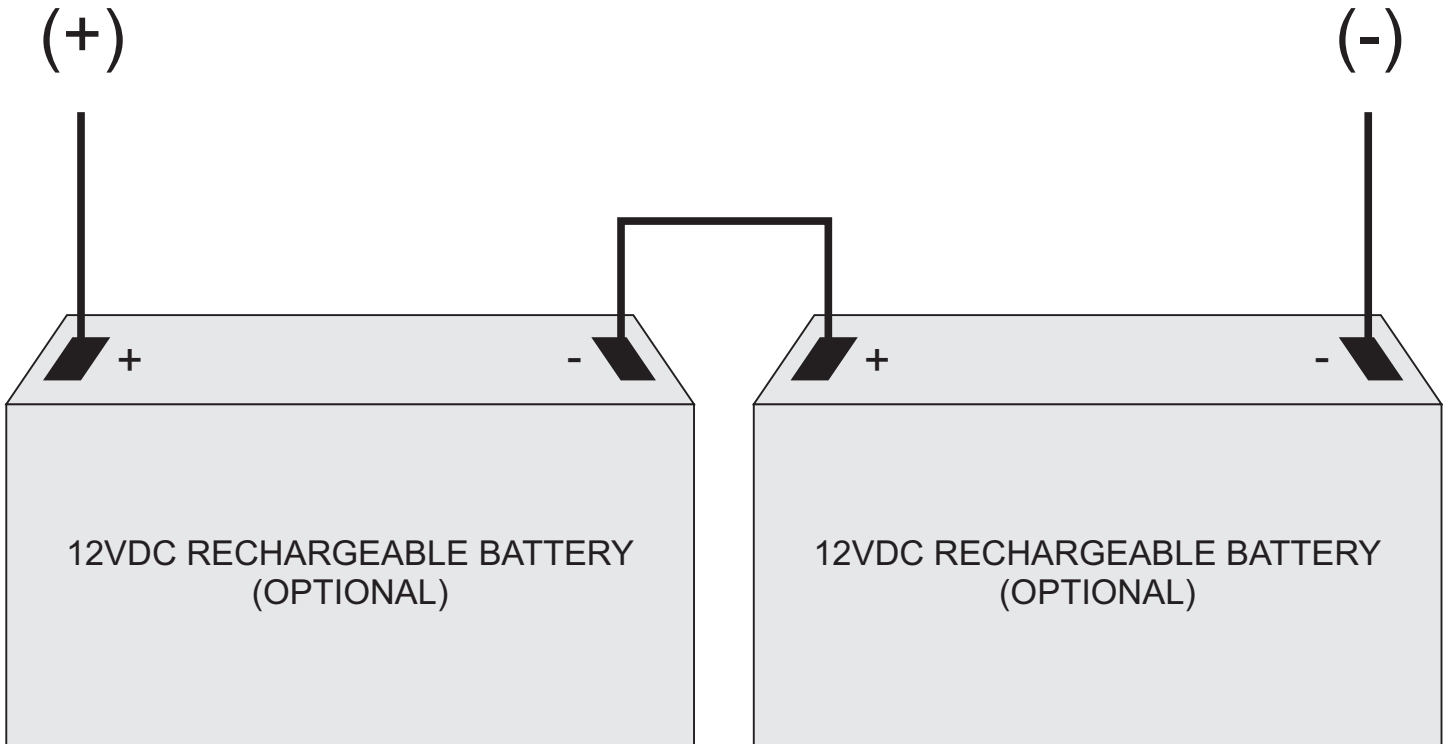

Units should be tested at least once a year for proper operation as follows:

Output Voltage Test: Under a normal load condition, the DC output voltage should be checked for a proper voltage level.

Battery Test: Under normal load conditions, check that the battery is fully charged, check specified voltage at the battery terminals and the board terminals to insure that there is no break in the battery connection wires.

Expected battery life is 5 years, however, it is recommended to change the batteries within two years or less if necessary.

	MODEL 5600-12	MODEL 5600-24
INPUT POWER:	115 VAC 50-60Hz, 2.0 Amp	115 VAC 50-60Hz, 2.0 Amp
OUTPUT POWER:	12 VDC Nominal (13.8 VDC) @ 10 Amp	24 VDC Nominal (27.6 VDC) @ 5 Amp
PRIMARY FUSE:	4A, 250V Slow-Blow	4A, 250V Slow-Blow
OUTPUT FUSE:	(2) 12A, 250V Slow Blow	(2) 6A, 250V Slow Blow



MEA
Approved
#23-92-E

Note: Refer to 5000 Series Power Supply Installation Manual

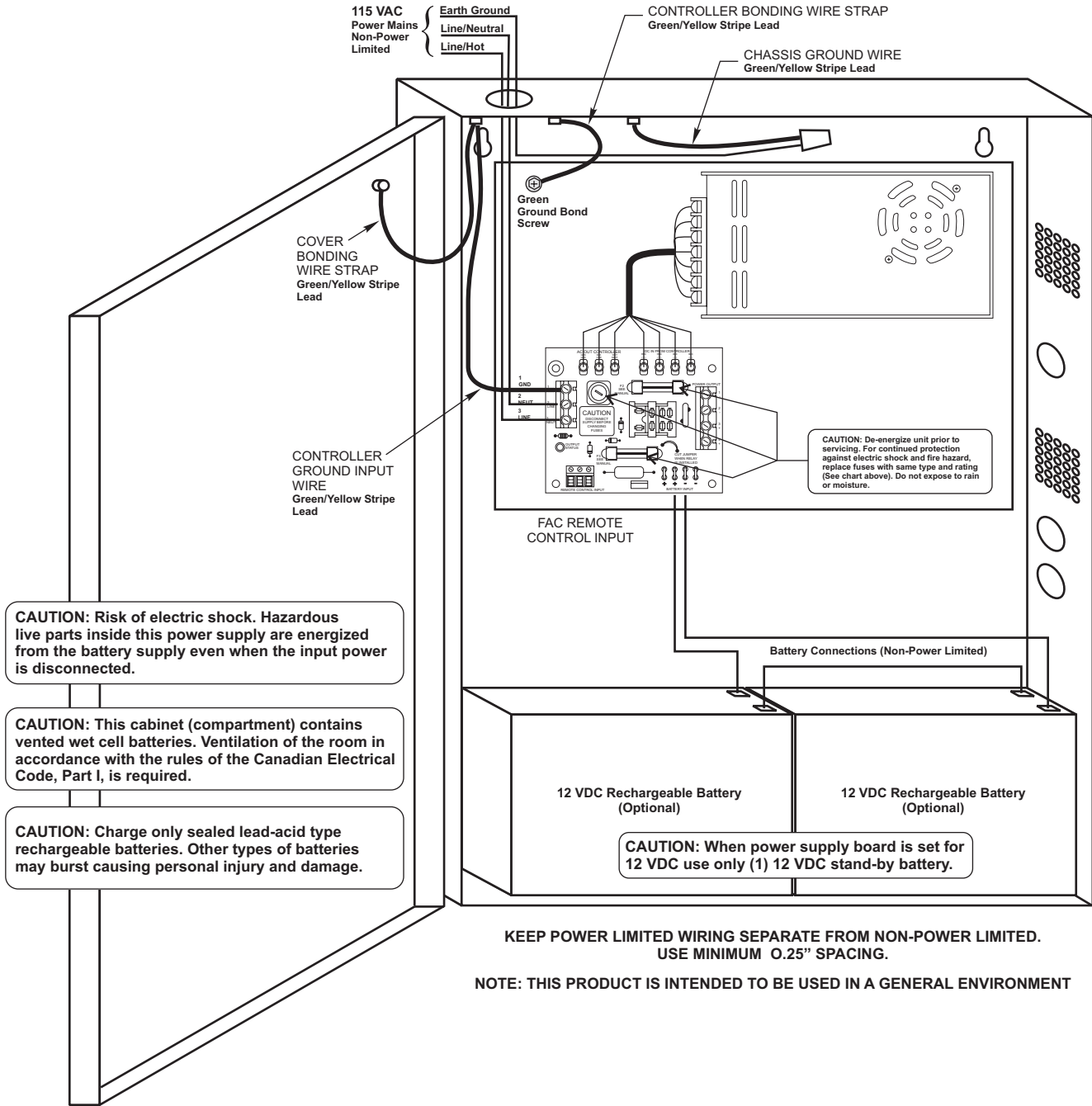

UL Listed General Purpose Power Supply

MODEL 5500	
INPUT POWER:	115 VAC 50-60Hz, 1.0 Amp
OUTPUT POWER:	12 VDC Nominal (13.8 VDC) @ 3 Amp or 24 VDC Nominal (27.6 VDC) @ 2 Amp
PRIMARY FUSE:	1A, 250V Slow-Blow
OUTPUT FUSE:	(2) 5A, 250V Slow Blow



MEA
Approved
#23-92-E

Note: Refer to 5000 Series Power Supply Installation Manual

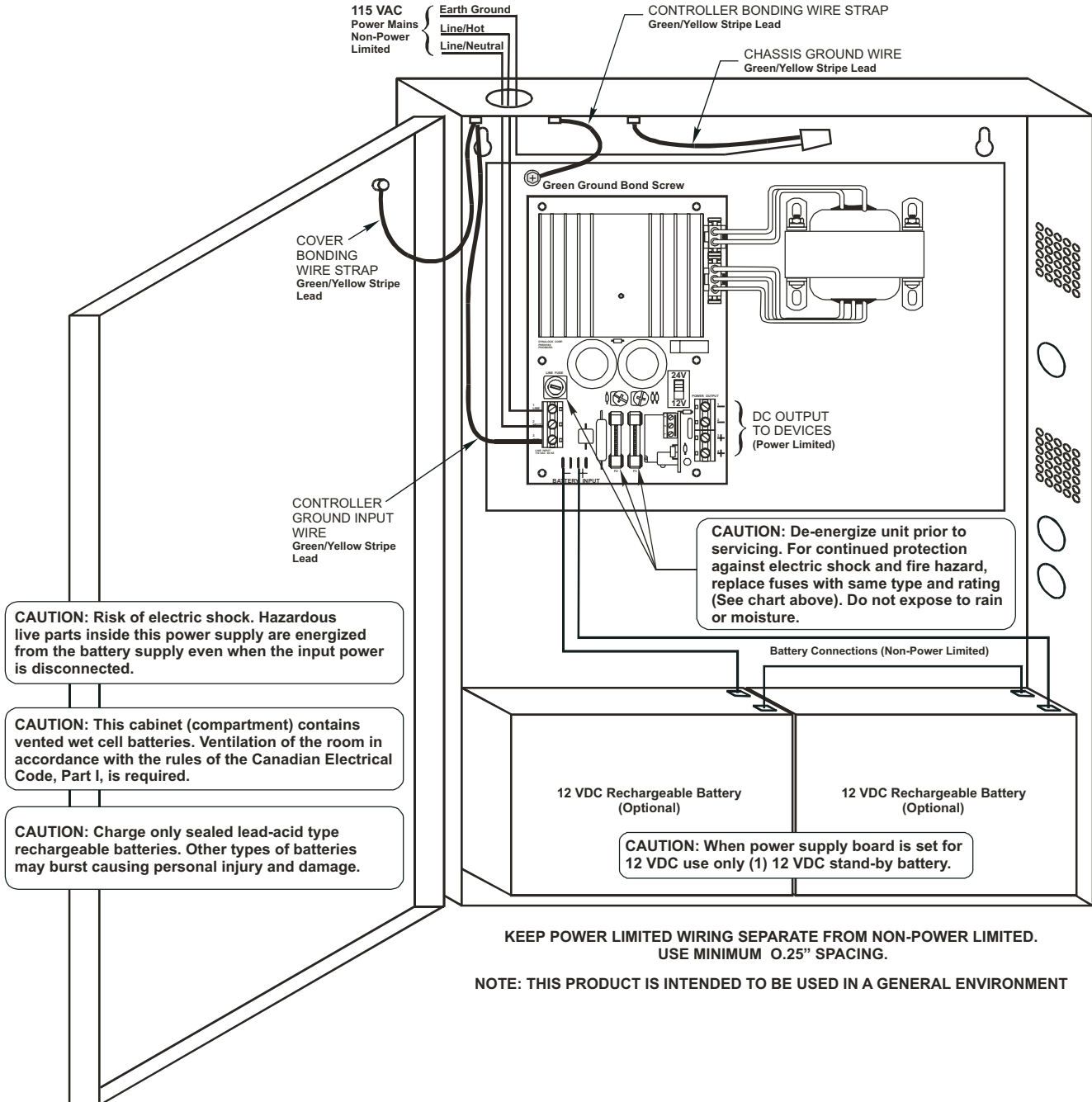

UL Listed General Purpose Power Supply

MODEL 5025	
INPUT POWER:	115 VAC 50-60Hz, 0.45 Amp
OUTPUT POWER:	12 VDC Nominal (13.8 VDC) @ 1 Amp or 24 VDC Nominal (27.6 VDC) @ 1 Amp
PRIMARY FUSE:	Resettable PTCC



MEA
Approved
#23-92-E

Note: Refer to 5000 Series Power Supply Installation Manual

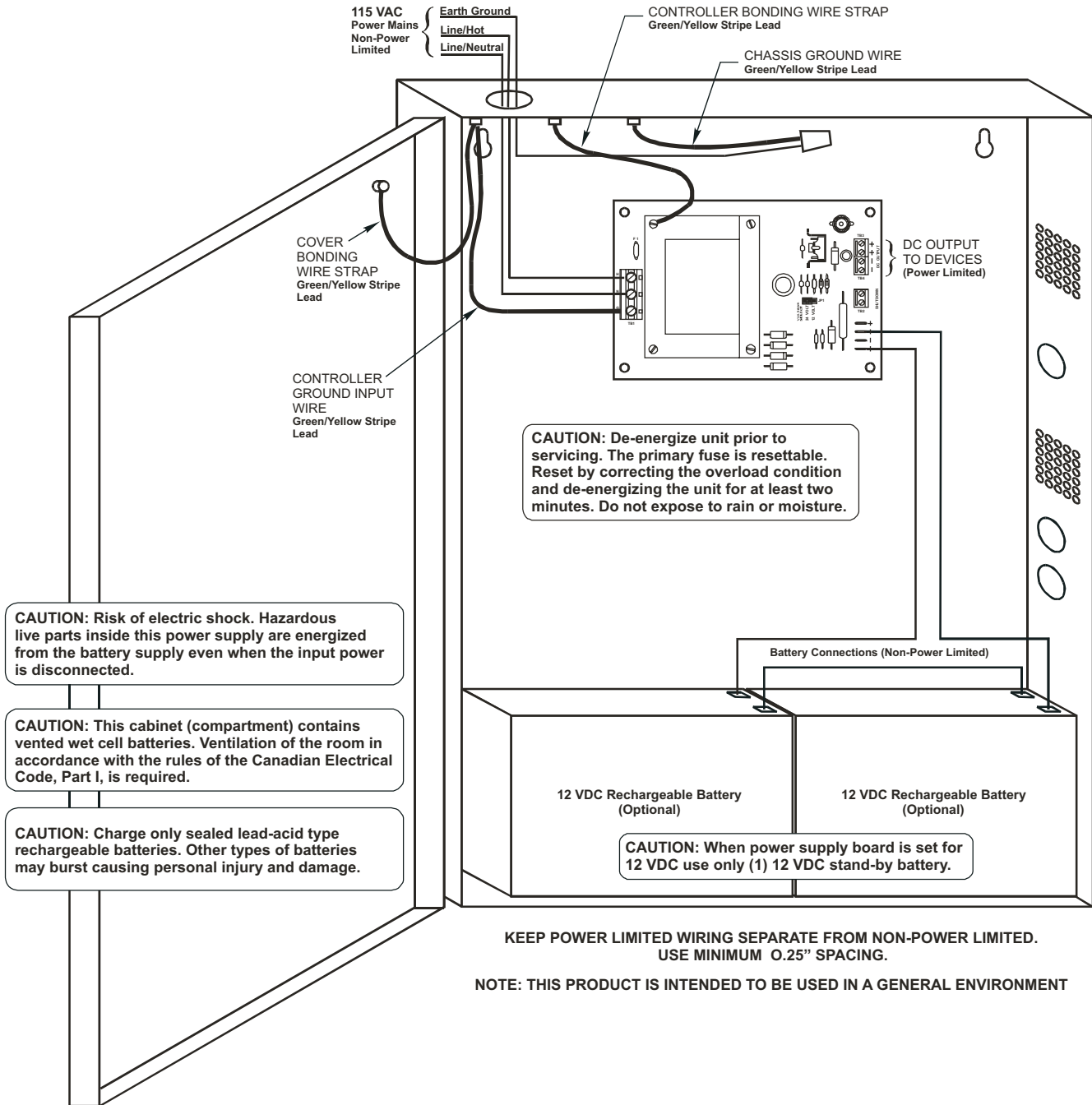

5500/5600 OPTIONS

FAC Option (Remote Control)

Kills all voltage outputs when interfaced with remote dry contact.

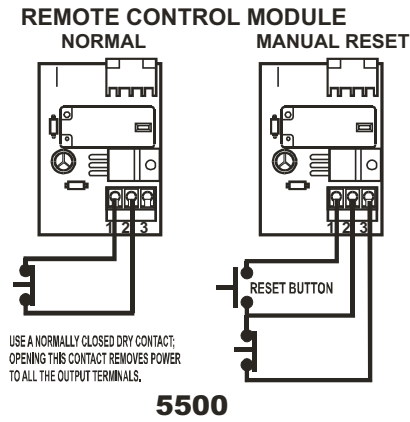

USE A NORMALLY CLOSED & A NORMALLY OPEN DRY CONTACT; OPENING THE NORMALLY CLOSED CONTACT REMOVES POWER TO ALL THE OUTPUT TERMINALS. TO RESET; REAPPLY THE NORMALLY CLOSED CONTACT ACROSS TERMINALS 2 & 3 AND MOMENTARILY PRESS THE RESET BUTTON.

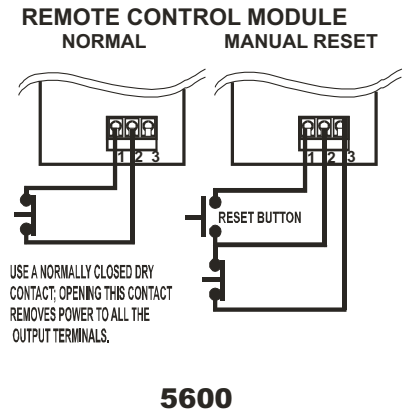

DB-5 & DB-10 Option (Distribution Board)

Two size distribution (5 or 10 position) are available to provide individually fused output terminals for each lock zone.

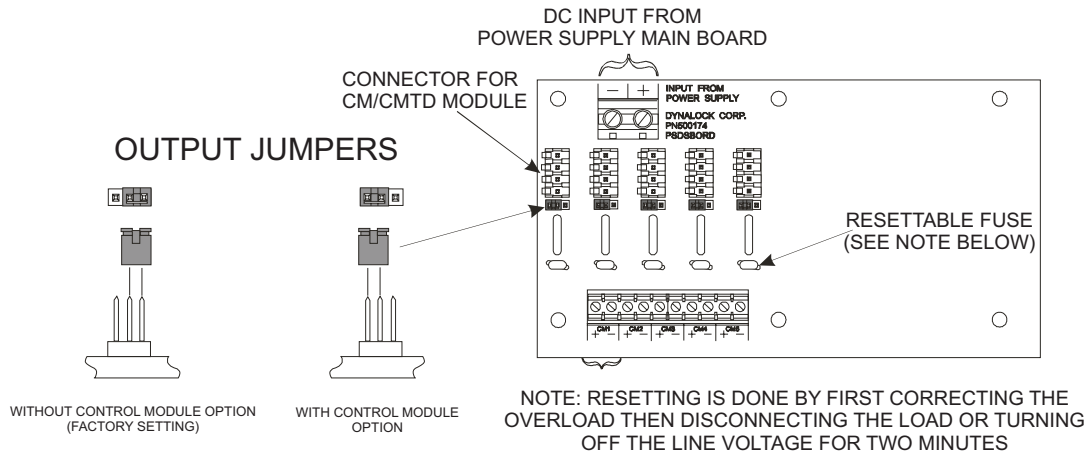

5500/5600 OPTIONS

CM Option (Control Module)

Accepts access/egress control dry contact input. Provides SPDT relay output.

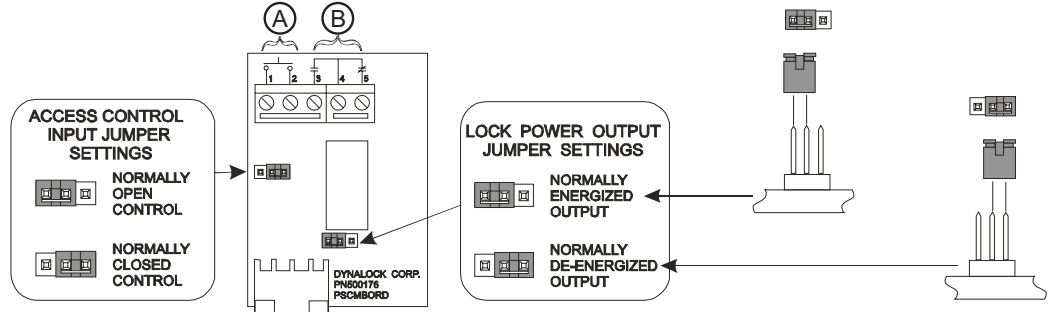

(A) ACCESS CONTROL INPUT (DRY CONTACTS ONLY)

(B) SPDT DRY CONTACTS RATED AT 2A @ 24V

CMTD Option (Control Module with Time Delay)

same as CM Option with Relock Time Delay

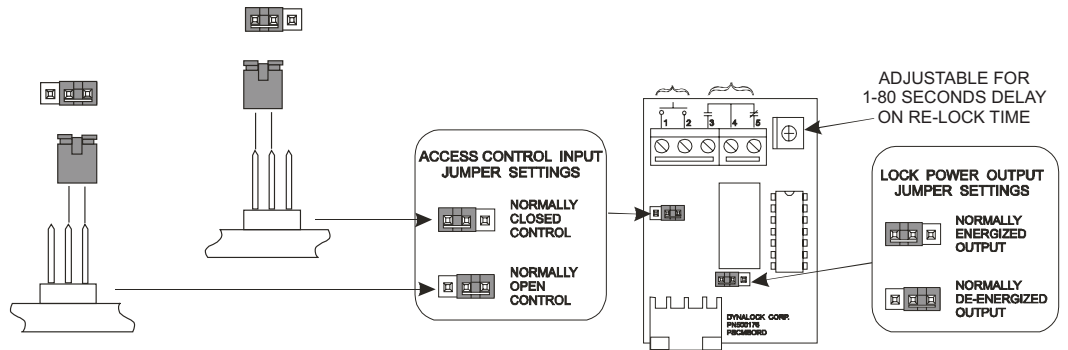

ATS Option (Anti-Tamper switch)

CONTACT HELD OPEN WITH ENCLOSURE COVER CLOSED

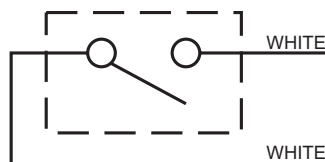

CONTACT CLOSED WITH ENCLOSURE COVER OPEN

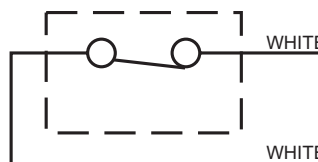

NOTE: ATS switch contacts rated .25A @ 24V

5500/5600 OPTIONS

ILB Option (Interlock Logic Board)

Provides Four DPDT Relay Outputs

Note: Separate ILB User Manual shows typical wiring diagrams.

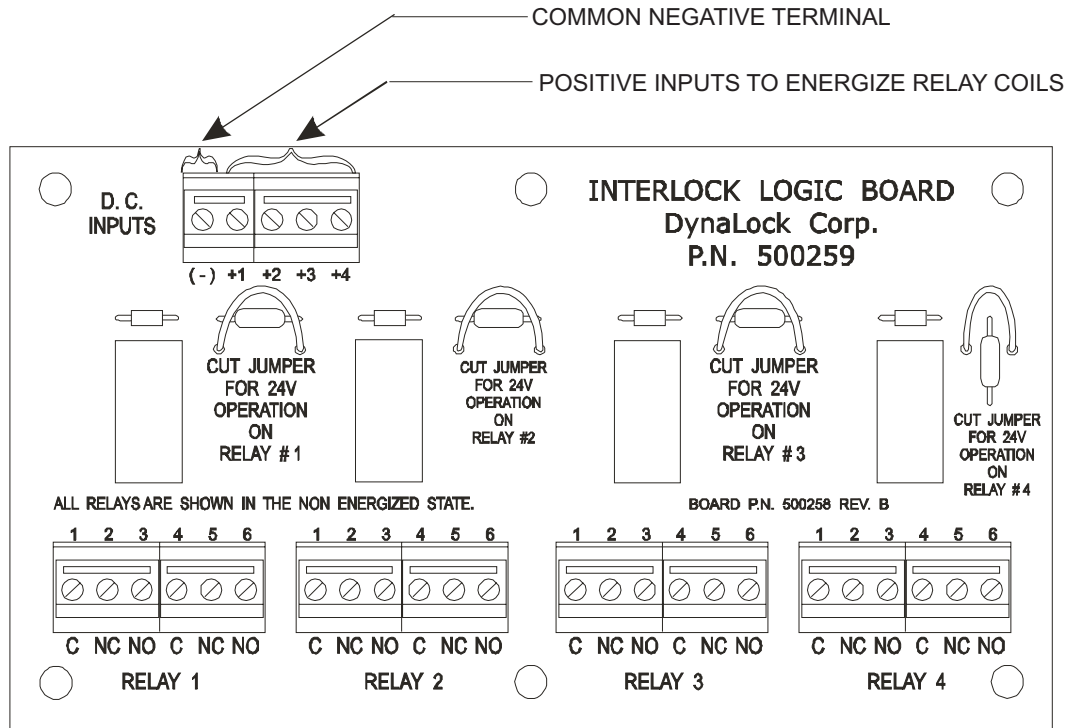

INSTALLATION INFORMATION

5600 LOCK CAPACITY

VOLTAGE	SINGLE (FULL SIZE)	DOUBLE (FULL SIZE)	SINGLE	DOUBLE	SINGLE DELAY EGRESS	DEADBOLT
12VDC	18	9	18	9	11	10
24VDC	18	9	18	9	8	9

CURRENT DRAW UP TO ½ AMP

VOLTAGE	20 AWG	18AWG	16AWG	14AWG	12AWG	10AWG
12VDC	50FT	100FT	150FT	250FT	400FT	625FT
24VDC	150FT	225FT	350FT	550FT	900FT	1375FT

5500 LOCK CAPACITY

VOLTAGE	SINGLE (FULL SIZE)	DOUBLE (FULL SIZE)	SINGLE	DOUBLE	SINGLE DELAY EGRESS	DEADBOLT
12VDC	6	3	6	3	3	3
24VDC	8	4	8	4	3	4

CURRENT DRAW UP TO ½ AMP

VOLTAGE	20 AWG	18AWG	16AWG	14AWG	12AWG	10AWG
12VDC	50FT	100FT	150FT	250FT	400FT	750FT
24VDC	100FT	200FT	300FT	500FT	750FT	1500FT

These charts indicates the minimum recommended wire size, local codes prevail.

TYPICAL 5500/5600 APPLICATION

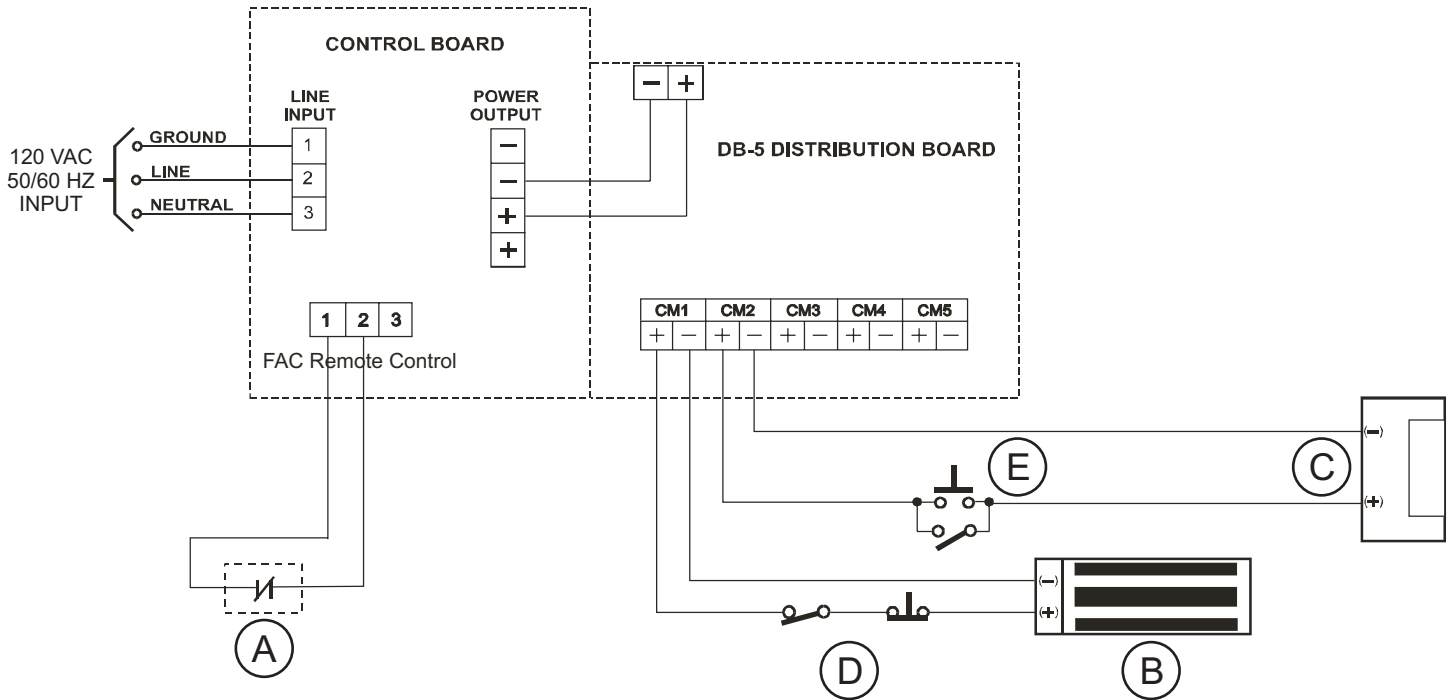

- (A) NORMALLY CLOSED DRY CONTACT FROM THE FIRE ALARM CONTROL PANEL (FROM OTHERS)
- (B) FAIL SAFE LOCKING DEVICE
- (C) FAIL SECURE LOCKING DEVICE
- (D) NORMALLY CLOSED ACCESS/EGRESS CONTROLS
- (E) NORMALLY OPEN ACCESS/EGRESS CONTROLS

5600 TROUBLESHOOTING

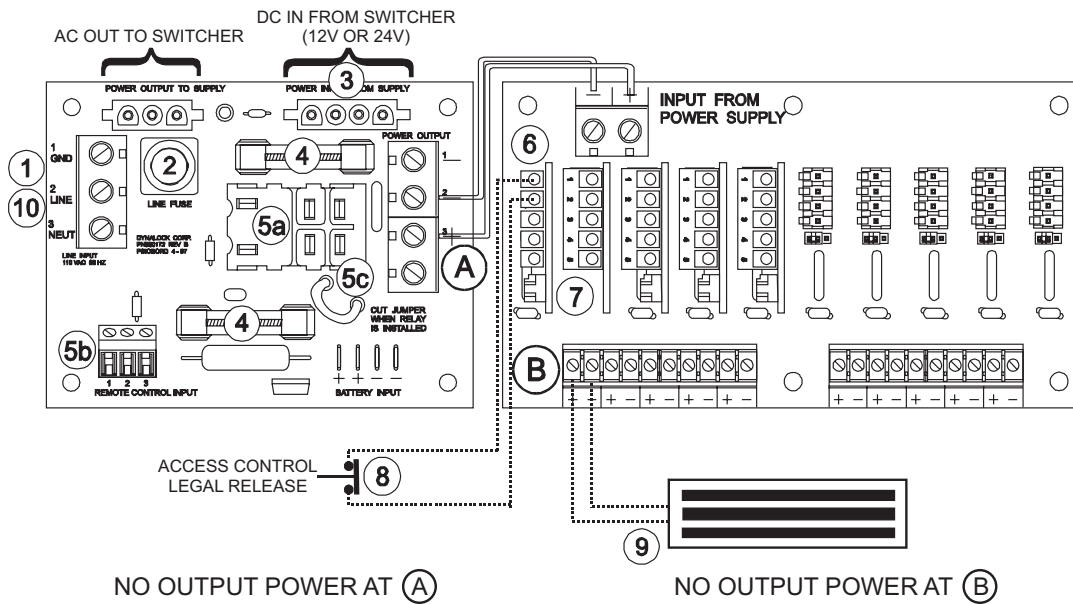

- | | |
|--|--|
| ① CHECK INPUT LINE FUSE | ⑥ CHECK JUMPER SETTING AT CM/CMTD MODULE (IF APPLICABLE) |
| ② CHECK LINE FUSE | ⑦ CHECK JUMPER SETTING AT DB-5/DB-10 CARD |
| ③ CHECK FOR 12 OR 24VDC FROM SWITCHER | ⑧ CHECK FOR PROPER ACCESS SWITCH CONTACT STATUS |
| ④ CHECK FOR 12 OR 24VDC FROM SWITCHER | ⑨ CHECK LOAD AND EXTERNAL WIRING FOR SHORT CONDITION |
| ⑤a CHECK F2 AND F3 OUTPUT FUSES
CHECK THAT FAC MODULE IS SEATED
PROPERLY (IF APPLICABLE) | ⑩ RESET POWER SUPPLY (WITH NO LOAD) BY
DISCONNECTING INPUT POWER AT AC LINE IN FOR
2 MINUTES |
| ⑤b TERMINALS 1 AND 2 MUST BE JUMPED
TOGETHER IF UNIT HAS FAC MODULE | |
| ⑤c | |

5500 TROUBLESHOOTING

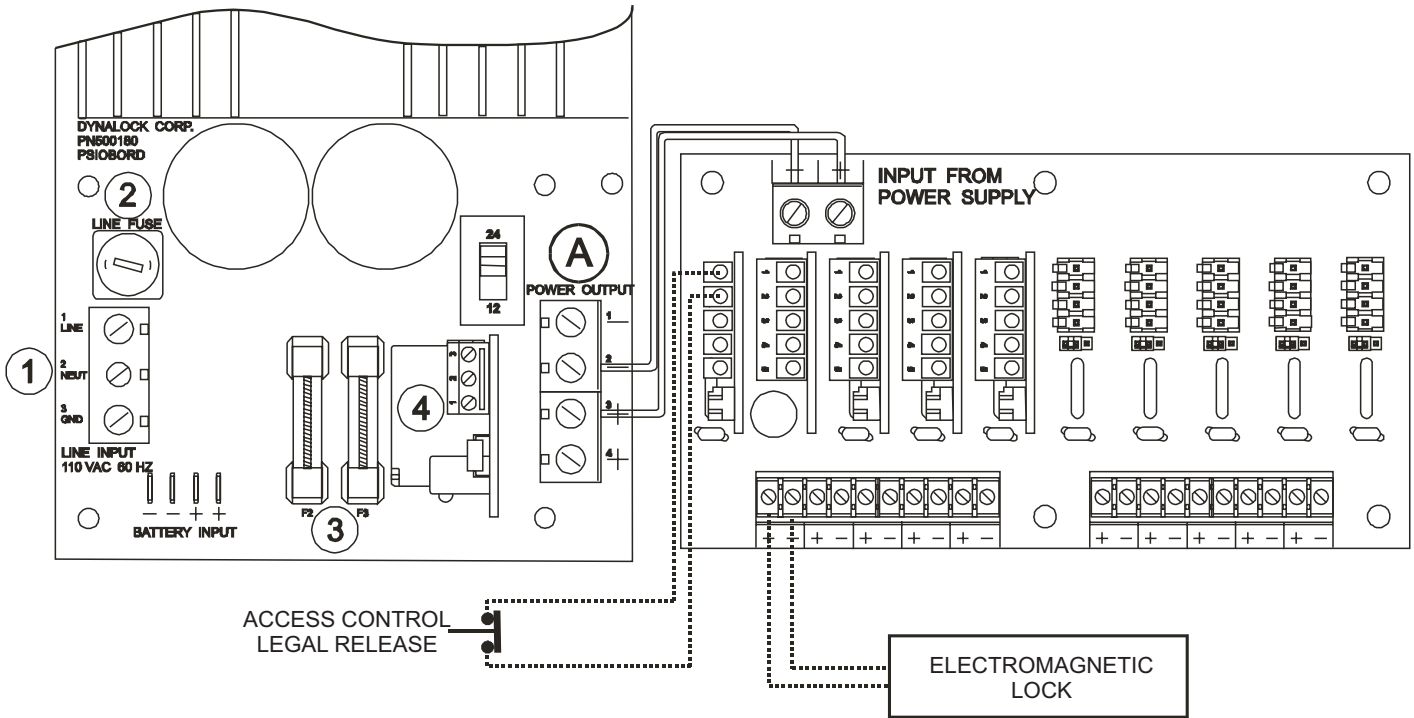

NO OUTPUT POWER AT (A)

- ① CHECK INPUT LINE POWER
- ② CHECK LINE FUSE
- ③ CHECK F2 & F3 OUTPUT FUSES
- ④ CHECK FAC (IF APPLICABLE) TERMINALS, 1 AND 2 MUST BE WIRED TO N/C CONTACT

5025 TROUBLESHOOTING

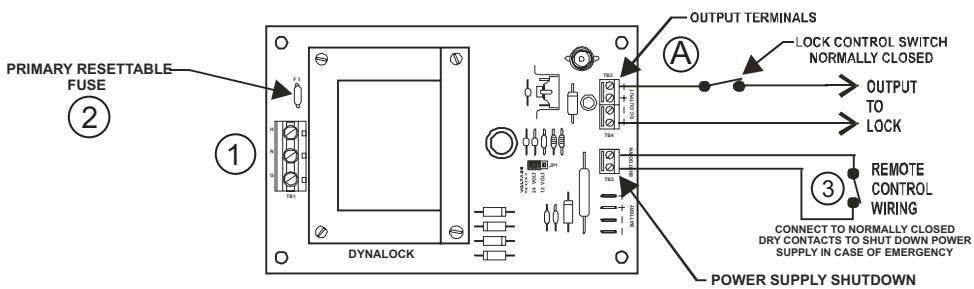

NO OUTPUT POWER AT (A)

- ① CHECK INPUT LINE POWER
- ② RESET POWER SUPPLY (WITH NO LOAD) BY DISCONNECTING POWER AT LEAST FOR 2 MINUTES
- ③ MAKE SURE YOU HAVE A CLOSURE BETWEEN THE 2 SHUT DOWN TERMINALS

POWER SUPPLY ENCLOSURE

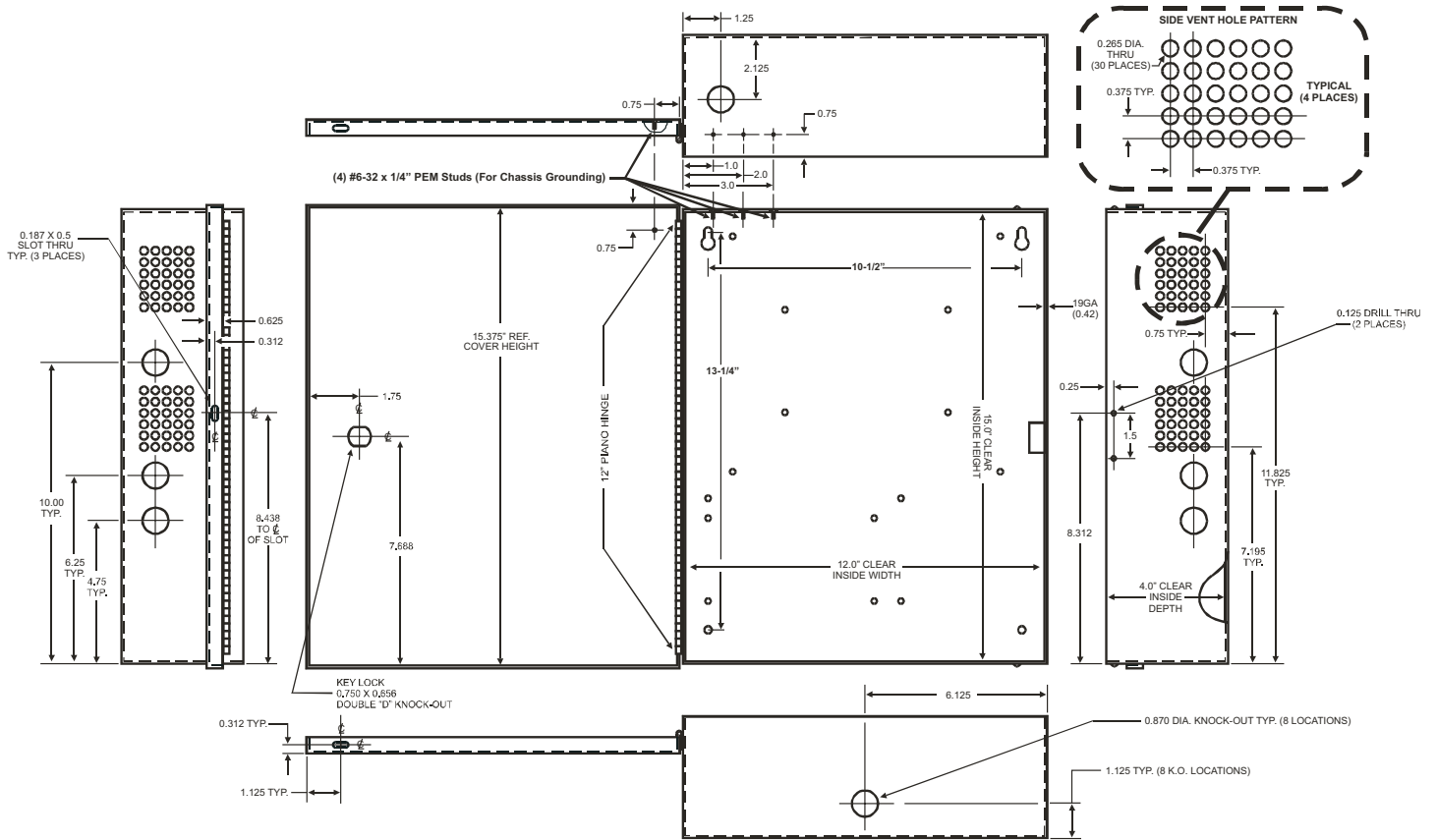

5000 SERIES PART LIST

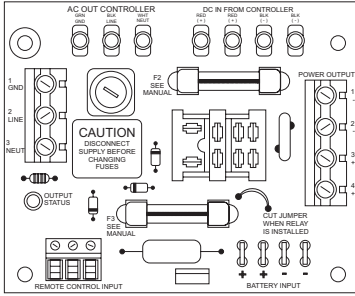

5600 12VDC
P/N 500333

5600 24VDC
P/N 500334

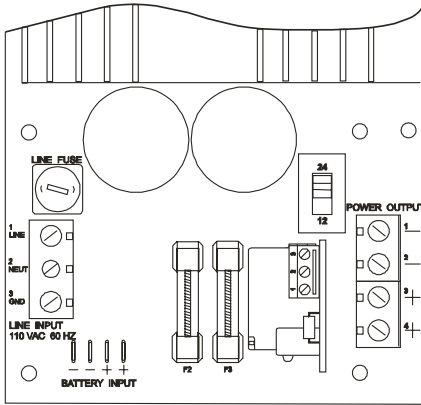

5500 P/N 500221

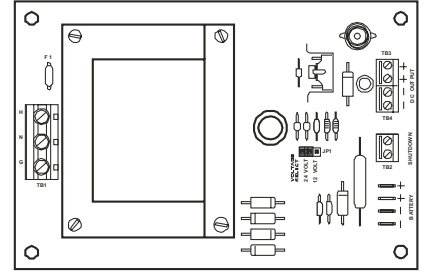

5025 P/N 500280

PRIMARY CIRCUIT BOARD PART NUMBERS

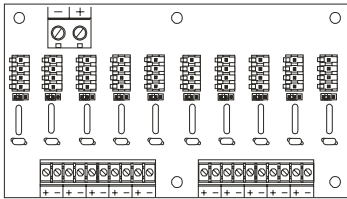

DB-10 DISTRIBUTION BOARD
P/N 500229

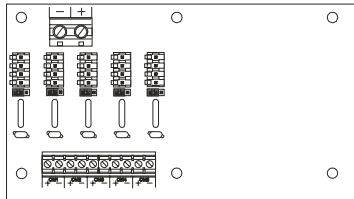

DB-5 DISTRIBUTION BOARD
P/N 500228

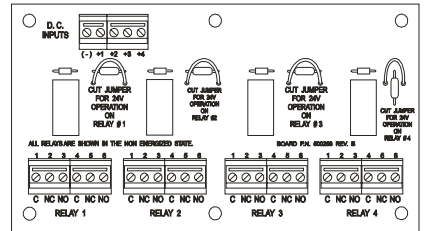

ILB BOARD
P/N 500259

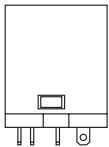

5600 REMOTE FIRE MODULE
(FAC) PLUG IN RELAY

24VDC P/N 500303

12VDC P/N 500302

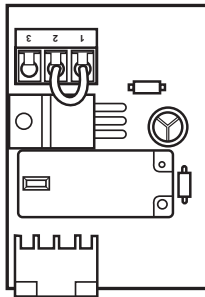

5500 REMOTE FIRE MODULE
(FAC) PLUG IN RELAY
P/N 500232

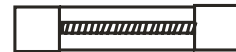

FUSES

- 1AMP P/N 500149
- 4AMP P/N 500332
- 5AMP P/N 500056
- 6AMP P/N 500203
- 12AMP P/N 500227

**PLEASE DELIVER THIS MANUAL
TO THE END USER UPON COMPLETION OF
THE POWER SUPPLY INSTALLATION**

**FOR PRODUCT SUPPORT AND PARTS
ORDERING INFORMATION CONTACT:**

DynaLock Corp.
705 Emmett Street
Bristol, CT 06010
Bus: (877) 396-2562 Toll-Free USA
(860) 582-4761
Fax: (860) 585-0338

DYNALOCK ON THE INTERNET:

E-mail: info@dynalock.com
Website: www.dynalock.com



QQFU/QQFU7 Power Supplies, General Purpose