



FOLGER ADAM SECURITY INC.
700 Series Replacement Parts

700 Astragal

A lock guard, designed to prevent tampering with the latchbolt keeper.

Features

- Finish—US4, satin brass, lacquered. US10, US10B, US26 or US26D.
- Supplied with Pan-Head Machine Screws.

Options

- Flat-Head Torx'; Tamper-Resistant Mounting Screws. (Torx' screw drivers are sold separately.)

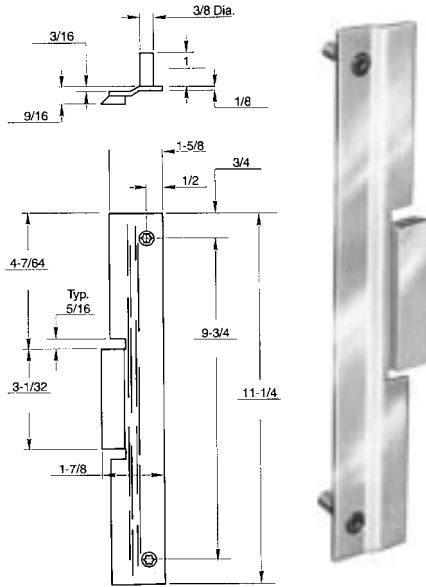

Locking Cam Spring for Fail-Safe Models
 003-0209-001
 (700-118)

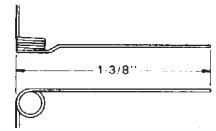

Locking Lever
 012-0612-001
 (700-105M)

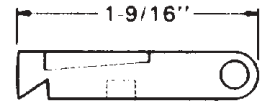

Locking Lever Pin
 012-0612-001
 (700-105M)



Solenoid Assembly Push Type
 076-0106-001-6 VDC
 076-0106-002-12VDC
 076-0106-003-16VDC
 076-0106-004-24VDC
 076-0106-005-48VDC
 076-0106-006-115VDC
 (700-134)

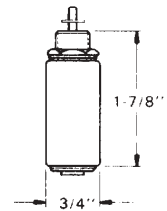

700 Replacement Parts

LBM Switch Tripper Spring
 012-0207-001
 (700-112)

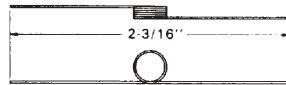

Latch Keeper - Standard
 012-0607-001
 (700-102M)

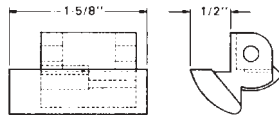

Latch Keeper - Pin
 011-0600-001
 (700-106)

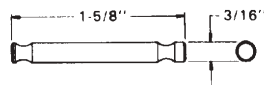

Latch Keeper for LBM Switch
 012-0608-001
 (700-143M)

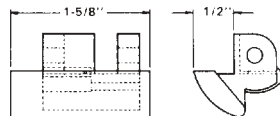

Solenoid Assembly Pull Type
 076-0107-001-6 VDC
 076-0107-002-12VDC
 076-0107-003-16VDC
 076-0107-004-24VDC
 076-0107-005-48VDC
 076-0107-006-115VDC
 (700-135)

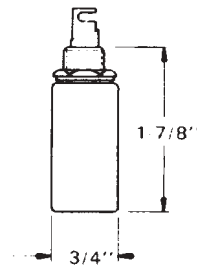

Latch Keeper Spring
 003-0203-001
 (310-106)

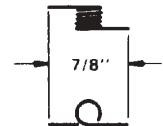

Locking Cam 710, 712 & 722
 076-0200-001
 (700-104M)

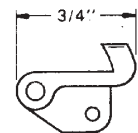



FOLGER ADAM SECURITY INC.

700 Series Replacement Parts

Locking Cam
730 & 732
076-0201-001
(700-115M)

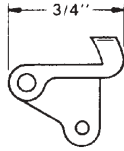

Switch Mounting Bracket
008-0602-001
(700-117)

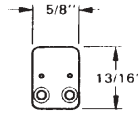

Front Cover
008-0600-001
(700-109)

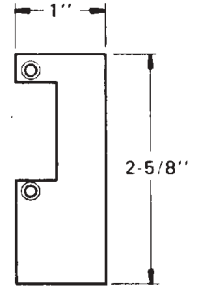

Locking Cam Pin
011-0601-001
(700-107)

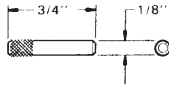

Strain Relief Insert
005-4905-001
(700-123)

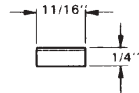

Locking Cam Spring
710, 712 & 722
003-0208-001
(700-113)

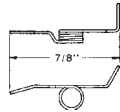

Rectifier
0 to 120 Volts
076-0712-012

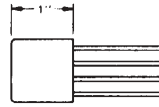

Back Cover
008-0601-001
(700-110)

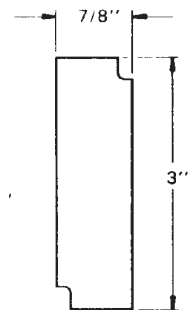

Locking Cam Spring
730, 732
003-0202-001
(700-113A)

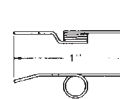

Case Assembly
076-0007-001
(700-100)

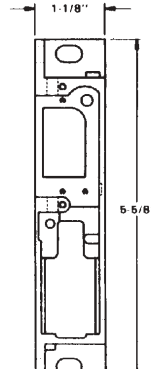

Roll Pin
010-0978-000
(700-119)

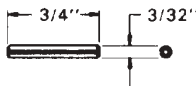

Locking Lever Spring
003-0000-001
(310-111)

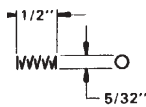

Baffle
008-0603-001
(700-150)

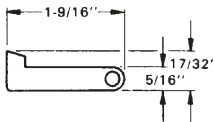

LBM Switch Tripper
012-0609-001
(700-103M)

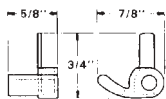

LBM Limit Switch
076-1202-001
(700-129)

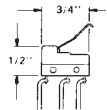

LCM Limit Switch
076-1203-001
(700-130)

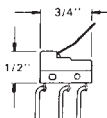

700 Series Faceplates

FA076-2002-001	712 faceplate w/screws-US3
FA076-2002-002	712 faceplate w/screws-US4
FA076-2002-003	712 faceplate w/screws-US10
FA076-2002-008	712 faceplate w/screws-32D
FA076-2003-005	722 faceplate w/screws-32D
FA076-2006-002	712-75 faceplate w/screws-US4
FA076-2006-003	712-75 faceplate w/screws-US10
FA076-2006-008	712-75 faceplate w/screws-32D



Other finishes and faceplates also available.