



# FOLGER ADAM SECURITY INC.

## 300 Series Replacement Parts

### AS-MT-236 Mounting Tabs

The AS-MT-236 Mounting Tab is designed to be used with electric strikes No. 310-2, 310-2½, 310-3, 310-6, 712 and 722—also 401 Electric Deadbolt—when mounting in existing metal frames. Mounting screws included with tabs. Sold in pairs.



### 310-2-3 Astragal

A lock guard, designed to prevent tampering with the latchbolt keeper.

#### Features

- Finish—US4, US10, US10B, US26, US26D.
- Supplied with pan-head machine screws.

#### Options

- Flat-Head Torx® tamper-resistant mounting screws. (Torx® screw-driver not included).

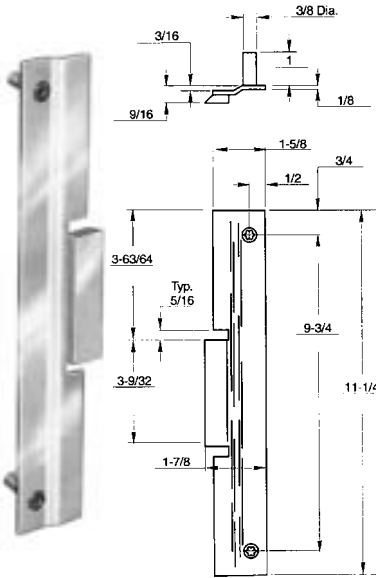

### 300 Series Faceplates

FA076-1924-001	310-2 faceplate-US3
FA076-1924-002	310-2 faceplate-US4
FA076-1924-008	310-2 faceplate-32D
FA076-1926-002	310-2-3/4" faceplate US4
FA076-1926-008	310-2.75 faceplate-32D
FA076-1927-001	310-4 faceplate-US3
FA076-1927-003	310-4 faceplate-US10
FA076-1927-019	310-4 faceplate 9/16" US32D
FA076-1927-020	310-4 faceplate-32D
FA076-1927-024	310-4 1/2" faceplate-32D
FA076-1939-010	310-3-1 US4 faceplate & Plug
FA076-1939-016	310-3-1 32D faceplate & Plug



Other finishes and faceplates also available.

### 310-1 Replacement Parts

#### Latch Keeper Pin

011-0401-001  
(310-105)

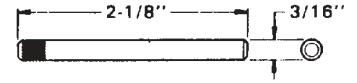

#### Locking Lever

012-0462-001  
(310-110M)

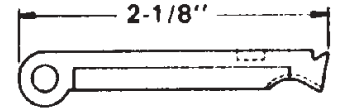

#### Locking Cam Pin

003-0402-001  
(310-109)

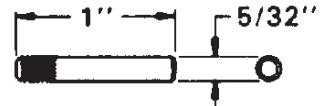

#### LBM Switch Tripper for 310-4-30 & 310-6-30

012-0464-001  
(310-116BC-1-30)

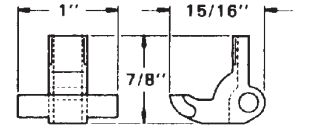

#### Switch Insulator

005-0719-001  
(ASE-9-2)

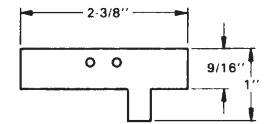

#### Solenoid Assembly

076-0123-001-12VAC  
076-0123-002-24VAC  
076-0123-003-120VAC  
076-0122-001-6 VDC  
076-0122-002-12VDC  
076-0122-003-24VDC  
076-0122-004-48VDC  
076-0122-005-115VDC  
(310-113)

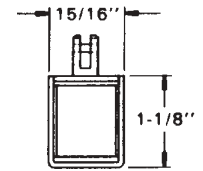

#### Solenoid Assembly-FS

076-0121-001-6VDC  
076-0121-002-12VDC  
076-0121-003-24VDC  
076-0121-004-48VDC  
076-0121-005-115VDC  
(310-126)

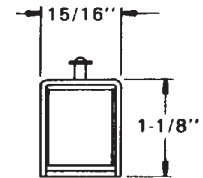

#### Rectifiers

0-15 Volts 076-0710-002  
16-30 Volts 076-0710-003  
48-120 Volts 076-0710-001

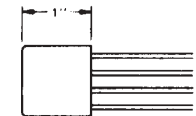

# FOLGER ADAM SECURITY INC.

## 300 Series Replacement Parts



### Latch Keepers

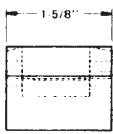

**Latch Keeper Spring**  
003-0203-001  
(310-106)

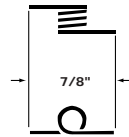

**Roll Pin**  
002-5301-002  
(310-115)

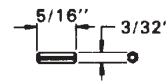

**Case Assembly**  
076-0006-001  
(310-101)

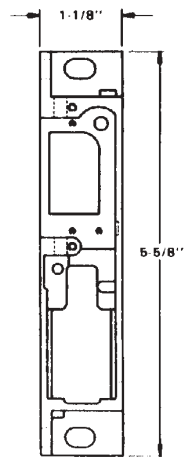

**Standard 3/4"**  
012-0488-001  
(310-104AM)

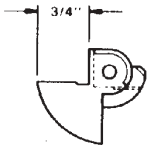

**Locking Cam**  
012-0460-001  
(310-107M)

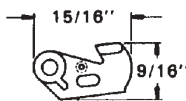

**LBM Switch Tripper for Unit Lock**  
010-0335-000  
(310-116AM)

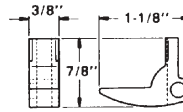

**Standard for Unit Lock**  
012-0455-001  
(310-104A-U)

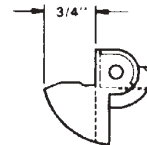

**Locking Cam Spring**  
003-0211-001  
(310-108)

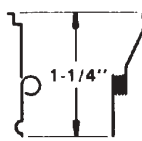

**LBM Switch Tripper**  
012-0463-001  
(310-116BC-1M)

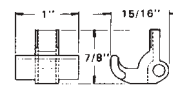

**Standard 1/2"**  
012-0487-001  
(310-104BM)

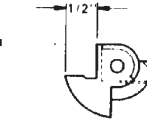

**Locking Cam Spring FS**  
003-0210-001  
(310-108FS)

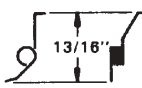

**Switch Tripper Spring**  
003-0300-001  
(310-117A)



**Upper Cover**  
008-0401-001  
(310-102)

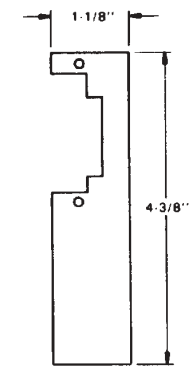

**Pullman (PK)**  
012-0489-001  
(310-104CM)

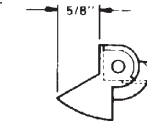

**Locking Cam Spacer**  
003-0405-001  
(310-106)

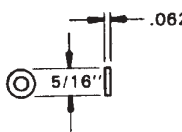

**LBM Limit Switch**  
076-1200-001  
(310-118LBM)

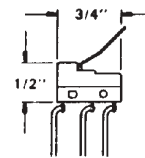

### Latch Keepers for Switch

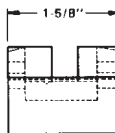

**Locking Lever Spring**  
003-0007-001  
(310-111)

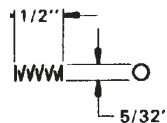

**LCM Limit Switch**  
076-1201-002  
(310-118LCM)



**3/4"**  
012-0492-001  
(310-104AS)

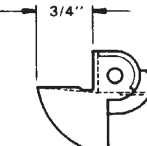

**Locking Lever Spacer**  
011-0404-001  
(310-151)

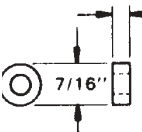

**LCBM Limit Switch**  
076-1201-001  
(310-118LCBM)

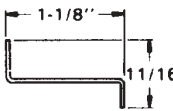

**Unit Lock**  
012-0459-001  
(310-104A-US)

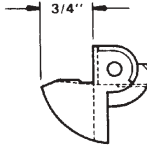

**Rubber Grommet**  
010-0339-200  
(310-112)

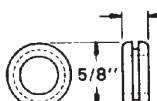

**LCM Switch Tripper**  
003-0302-001  
(310-119)

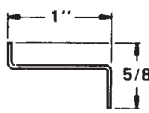

**1/2"**  
012-0491-001  
(310-104BS)

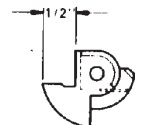

**Dust Cover**  
008-0404-001  
(310-149)



**Pullman (PK)**  
012-0493-001  
(310-104CS)

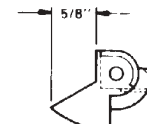

**Lower Cover**  
008-0402-001  
(310-103)

