

Classic Wrap Arouds

DON-JO has the most complete Wrap-Around line for repairing, remodeling and reinforcing. Their Wrap-Arouds save costly door replacement, help resist kick-in attacks and help keep wood doors from splitting.

When ordering specify finish after model number.

Example: CW-1-AB.

Available Finishes

- AB—Antique Brass—US5 (609)
- 10B—Oil Rubbed Bronze—US10B (613)
- BZ—Satin Bronze—US10 (612)
- PB—Polished Brass—US3 (605)
- S—Stainless Steel—US32D (630)

Built-in stainless steel threaded insert

Long lasting and secure mounting of latch and bolt

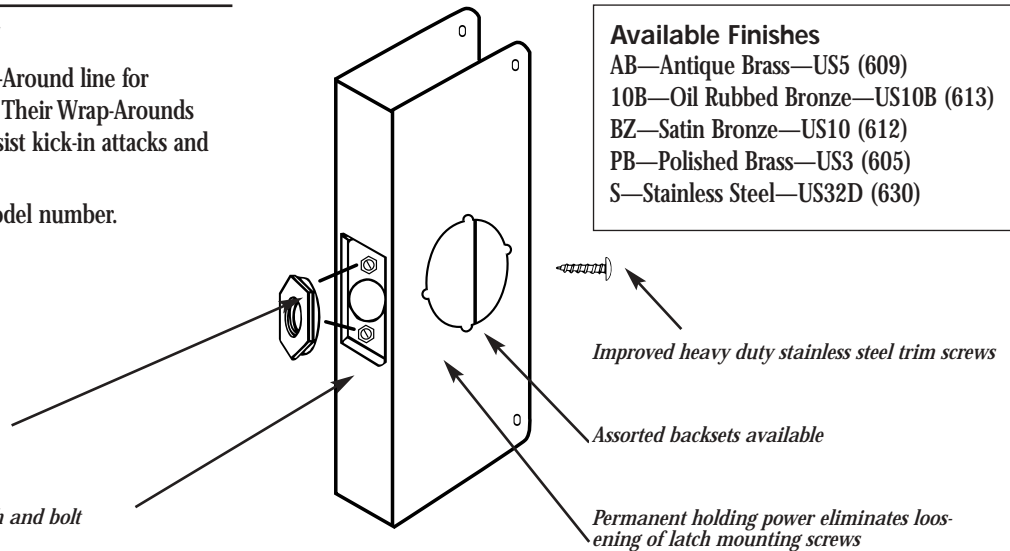

For Cylindrical Door Locks 2-1/8" Hole

- 21 (.032) Gauge Steel
- Finishes—PB (605), AB (609), BZ (612), 10B (613), S (630)

NOTE: Strike not included.

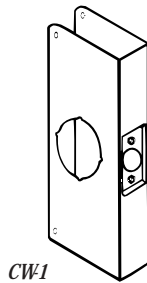

NUMBER	BACKSET	DOOR	DIMENSIONS
CW-1	2-3/8"	1-3/8"	4" x 9"
CW-2	2-3/8"	1-3/4"	4" x 9"
CW-3	2-3/4"	1-3/8"	4-1/4" x 9"
CW-4	2-3/4"	1-3/4"	4-1/4" x 9"

For Conversion of Simplex 1000 Series and Alarm Lock Trilogy Series to Key-in-Knob Lock.

- For Conversion of Simplex 1000 Series and Alarm Lock DL2500, 2700/T2 and 3000 Series.
- 21 (.032) Gauge Steel
- Finishes—PB (605), AB (609), S (630)

NOTE: Strike not included.

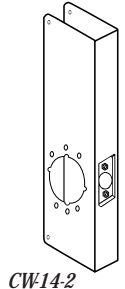
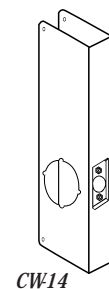

NUMBER	BACKSET	DOOR	DIMENSIONS
CW-14	2-3/4"	1-3/4"	5" x 14"
CW-14-2	2-3/4"	1-3/4"	5" x 14"

For Deadbolts with 1-1/2" Hole

- 21 (.032) Gauge Steel
- Finishes—PB (605), AB (609), BZ (612), 10B (613), S (630)

NOTE: Strike not included.

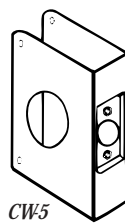

NUMBER	BACKSET	DOOR	DIMENSIONS
CW-5	2-3/8"	1-3/8"	4" x 4-1/2"
CW-6	2-3/8"	1-3/4"	4" x 4-1/2"
CW-7	2-3/4"	1-3/8"	4-1/4" x 4-1/2"
CW-8	2-3/4"	1-3/4"	4-1/4" x 4-1/2"

DON-JO MANUFACTURING, INC.

Classic Wrap Arouds

Simplex 1000 Series and Trilogy

Fits Simplex 1000 Series and Alarm Lock Trilogy Locks.

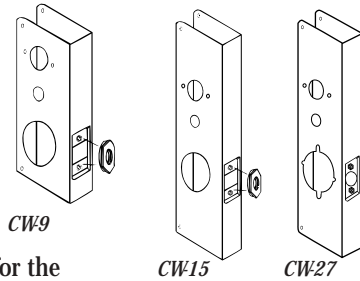

- CW-9 and CW-15 are for the Simplex 1000 and Trilogy DL2500 and DL2700/T2.
- CW15 Series also available beveled for a custom fit. Handing only needs to be specified on beveled units.
- CW27 Series is for Alarm Lock Trilogy T2, and 3000 Series T3.
- 21 (.032) Gauge Steel
- Finishes—PB (605), AB (609), S (630)

NOTE: Strike not included.

NUMBER	BACKSET	DOOR	DIMENSIONS
CW-9	2-3/4"	1-3/4"	5" x 9"
CW-15	2-3/4"	1-3/4"	5" x 15"
CW-27	2-3/4"	1-3/4"	5" x 15"

For Use With Heavy Duty Grade 1 Key-in-Levers.

Works with Schlage Rhodes, Arrow Q & H Series Sierra, Yale 5400LN Series, Sargent 10-Line, Corbin Russwin CL3300 and CL3600 Series and Falcon T Series.

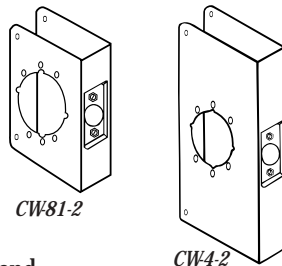

- 21 (.032) Gauge Steel
- Finishes—CW-4-2: PB (605), BZ (612), S (630)
CW-81-2: PB (605), AB (609), BZ (612), S (630)

NOTE: Strike not included.

NUMBER	BACKSET	DOOR	DIMENSIONS
CW-4-2	2-3/4"	1-3/4"	4-3/4" x 9"
CW-81-2	2-3/4"	1-3/4"	4-3/4" x 4-1/2"

For Cylindrical Door Locks with 2-1/8" Hole

- 21 (.032) Gauge Steel
- Finishes—PB (605), AB (609), BZ (612), 10B (613), S (630)

NOTE: Strike not included.

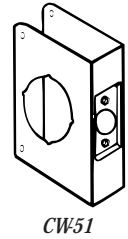

NUMBER	BACKSET	DOOR	DIMENSIONS
CW-51	2-3/8"	1-3/8"	4" x 4-1/2"
CW-61	2-3/8"	1-3/4"	4" x 4-1/2"
CW-71	2-3/4"	1-3/8"	4-1/4" x 4-1/2"
CW-81	2-3/4"	1-3/4"	4-1/4" x 4-1/2"

For Unican 4000 Series

- 21 (.032) Gauge Steel
- Finishes—PB (605), AB (609), S (630)

NOTE: Strike not included.

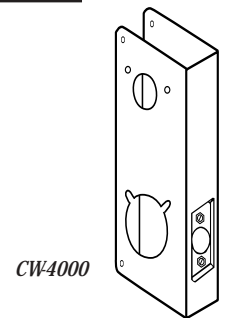

NUMBER	BACKSET	DOOR	DIMENSIONS
CW-4000-2	2-3/8"	1-3/4"	5" x 15"
CW-4000-4	2-3/4"	1-3/4"	5" x 15"

For Mas-Hamilton Power Levers

- 21 (.032) Gauge Steel
- Finishes—PB (605), AB (609), S (630)

NOTE: Strike not included.

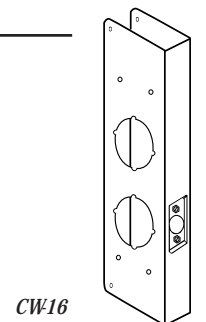

NUMBER	BACKSET	DOOR	DIMENSIONS
CW-16	2-3/4"	1-3/4"	5" x 15"

For Double Combination Locksets with 2-1/8" Holes with 3-5/8" Centers

- 21 (.032) Gauge Steel
- Finishes—PB (605), AB (609), BZ (612), 10B (613), S (630)

NOTE: Strike not included.

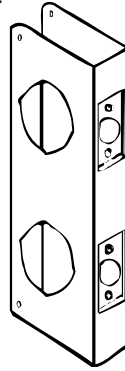

NUMBER	BACKSET	DOOR	DIMENSIONS
CW-151	2-3/8"	1-3/8"	4" x 9"
CW-261	2-3/8"	1-3/4"	4" x 9"
CW-481	2-3/4"	1-3/4"	4-1/4" x 9"

Blank Wrap-Around with Trim Screw Holes

- 21 (.032) Gauge Steel
- Finishes—PB (605), AB (609), BZ (612), 10B (613), S (630)

NOTE: Strike not included.

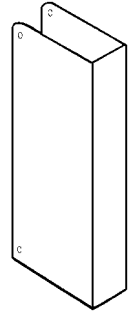

NUMBER	BACKSET	DOOR	DIMENSIONS
CW-30	—	1-3/8"	4-1/4" x 9"
CW-40	—	1-3/4"	4-1/4" x 9"
CW-70	—	1-3/8"	4-1/4" x 4-1/2"
CW-80	—	1-3/4"	4-1/4" x 4-1/2"
CW-90	—	1-3/4"	5" x 12"

For Double Lock Combination Locksets with 2-1/8" Holes with 4" Centers.

- 21 (.032) Gauge Steel
- Finishes—PB (605), AB (609), BZ (612), 10B (613), S (630)

NOTE: Strike not included.

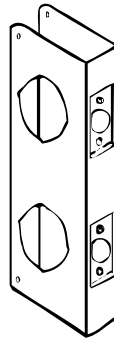

NUMBER	BACKSET	DOOR	DIMENSIONS
CW-942	2-3/8"	1-3/4"	4" x 9"
CW-943	2-3/4"	1-3/4"	4-1/4" x 9"

For Best and Sargent Levers

For installing the Best 93K lever lock, 73K locksets, Sargent 6500 Series.

- 21 (.032) Gauge Steel
- Finishes—PB (605), AB (609), BZ (612), S (630)

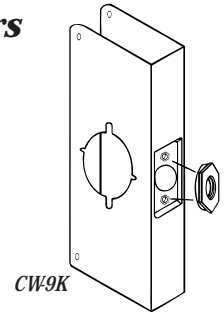

NUMBER	BACKSET	DOOR	DIMENSIONS
CW-5K	2-3/4"	1-3/4"	4-3/4" x 5-1/2"
CW-9K	2-3/4"	1-3/4"	4-3/4" x 9"

DON-JO MANUFACTURING, INC.

Classic Wrap Arouds

Mortise Lock Wrap-Around Plate for 86 Cut-Out

- 21 (.032) Gauge Steel
- Finishes—PB (605), AB (609), S (630)
- 8" x 1-1/4" Recess
- Drill spindle and thumb turn holes in field.

NOTE: Strike not included.

CW504

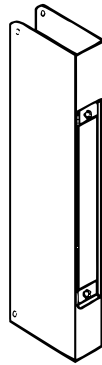

NUMBER	BACKSET	DOOR	DIMENSIONS
CW-504	—	1-3/4"	5" x 12"

For Cylindrical Door Locks with 2-1/8" Hole, 12" Height

- 21 (.032) Gauge Steel
- Finishes—PB (605), S (630)

NOTE: Strike not included.

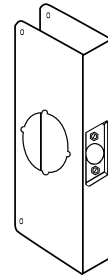

12-CW

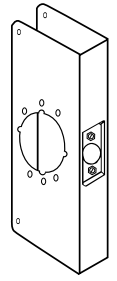

12-2-CW

NUMBER	BACKSET	DOOR	DIMENSIONS
CW-12	2-3/4"	1-3/4"	4-1/4" x 12"
CW-12-2	2-3/4"	1-3/4"	4-3/4" x 12"

Mortise Lock Wrap-Around Plate for 86 Cut-Out with Full Escutcheon Trim Plates

- 21 (.032) Gauge Steel
- Finishes—PB (605), AB (609), S (630)
- 8" x 1-1/4" Recess
- Rectangle Size: 1-5/8" x 7-5/16"

NOTE: Strike not included.

CW514



NUMBER	BACKSET	DOOR	DIMENSIONS
CW-514	2-3/4"	1-3/4"	5" x 12"

20" Wrap Around — Beveled Front

- 21 (.032) Gauge Steel
- Finishes—PB (605), S (630)
- Non-handed.

NOTE: Strike not included.

CW20

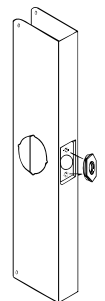

NUMBER	BACKSET	DOOR	DIMENSIONS
CW-20	2-3/4"	1-3/4"	5" X 20"
CW-20B	—	1-3/4"	5" X 20"
CW-20C	2-3/8"	1-3/4"	5" X 20"
CW-20-2	2-3/4"	1-3/4"	5" X 20"

Fits Best 93-KV Locks

- 21 (.032) Gauge Steel
- Finishes—PB (605), AB (609), S (630)

NOTE: Strike not included.

CW93-KV

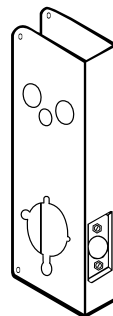

NUMBER	BACKSET	DOOR	DIMENSIONS
CW-93-KV	2-3/4"	1-3/4"	5-1/2" X 12-3/4"

Classic Wrap Arounds

For Double Lock Combination Locksets with 6" Centers

For double combination locksets with 1-1/2" or 2-1/8" holes with 6" centers.

- 21 (.032) Gauge Steel
- Finishes—PB (605), S (630)

NOTE: Strike not included.

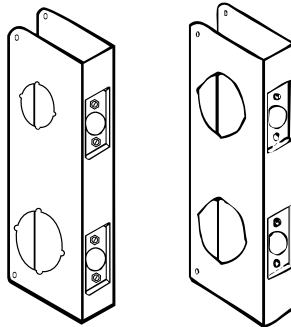

CW-486
Hole Sizes
1-1/2" over
2-1/8"

CW-946
Hole Sizes
2-1/8" over
2-1/8"

NUMBER	BACKSET	DOOR	DIMENSIONS
CW-486	2-3/4"	1-3/4"	4-1/2" x 12"
CW-946	2-3/4"	1-3/4"	4-1/2" x 12"

For Installing Marks and Medeco Levers

Marks Lock—170, 270, 195 and 295 Series.

Medeco—18, 19 Series

- 21 (.032) Gauge Steel
- Finishes—PB (605), AB (609), BZ (612), S (630)

NOTE: Strike not included.

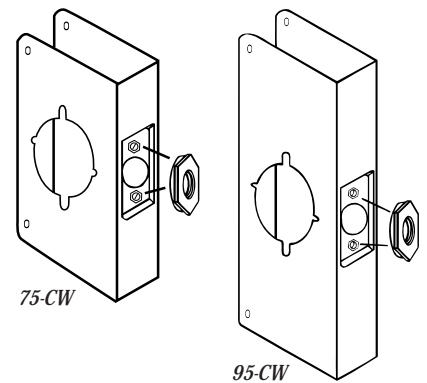

NUMBER	BACKSET	DOOR	DIMENSIONS
CW-75	2-3/4"	1-3/4"	4-3/4" x 5-1/2"
CW-95	2-3/4"	1-3/4"	4-3/4" x 9"

For Locks with Extended or Converted Backsets

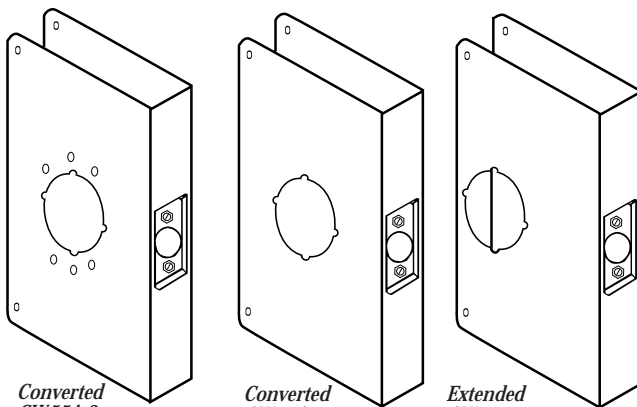

Converted
CW-55A-2
CW-33A-2

Converted
CW-55A
CW-33A

Extended
CW-55
CW-33

- 21 (.032) Gauge Steel
- Finishes—PB (605), AB (609), BZ (612), 10B (613), S (630)

NOTE: Strike not included.

NUMBER	BACKSET	DOOR	DIMENSIONS
CW-33	3-3/4"	1-3/4"	5-1/2" x 9"
CW-33A	2-3/4"	1-3/4"	6-1/2" x 9"
CW-33A-2	2-3/4"	1-3/4"	6-1/2" x 9"
CW-55	5"	1-3/4"	6-1/2" x 9"
CW-55A	2-3/4"	1-3/4"	6-1/2" x 9"
CW-55A-2	2-3/4"	1-3/4"	6-1/2" x 9"

For Thicker Doors

- Latch hole centered in door.
- Available with lever prep.—custom order only.
- 21 (.032) Gauge Steel
- Finishes—PB (605), S (630)

NOTE: Strike not included.

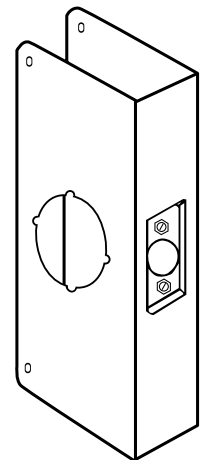

NUMBER	BACKSET	DOOR	DIMENSIONS
CW-200	2-3/4"	2"	4-1/4" x 9"
CW-200C	2-3/8"	2"	4-1/4" x 9"
CW-212	2-3/4"	2-1/2"	4-1/4" x 9"
CW-212C	2-3/8"	2-1/2"	4-1/4" x 9"
CW-214	2-3/4"	2-1/4"	4-1/4" x 9"
CW-214C	2-3/8"	2-1/4"	4-1/4" x 9"